

**PRELIMINARY REPORT ON THE AIR ACCIDENT NEAR TURØY, ØYGARDEN  
MUNICIPALITY, HORDALAND COUNTY, NORWAY 29 APRIL 2016 WITH AIRBUS  
HELICOPTERS EC 225 LP, LN-OJF, OPERATED BY CHC HELIKOPTER SERVICE AS**

28 April 2017

Accident Investigation Board Norway  
Postboks 213  
2001 Lillestrøm  
Norway  
Phone: + 47 63 89 63 00  
Fax: + 47 63 89 63 01  
<http://www.aibn.no>  
E-mail: [post@aibn.no](mailto:post@aibn.no)

## INTRODUCTION TO THE PRELIMINARY REPORT

The preliminary report is issued within 12 months following the accident in order to present an updated status of the investigation to the involved parties and to the public. This is in accordance with Regulation (EU) No. 996/2010 Article 16. Only the final report will represent the complete investigation and be the official document of the Accident Investigation Board Norway (AIBN).

The preliminary report, containing mainly factual information, is based on a standard ICAO Annex 13 format, with some alterations:

Chapter 1 *Factual information* contains selected facts and evidence available at this stage in the investigation. The chapter covers areas of information commonly included in investigation reports, including technical descriptions and explanatory text.

Chapter 2 *Comments from the Accident Investigation Board* contains analysis and conclusions drawn up to this point.

Chapter 3 *Further investigations* includes description of the main areas for the AIBN's continuing investigation.

Readers who wish to get only a brief overview of the accident and the investigation status, are advised to read the *Summary*, Chapter 2 *Comments from the Accident Investigation Board* and Chapter 3 *Further investigations*.

**INDEX**

INTRODUCTION TO THE PRELIMINARY REPORT.....	2
SUMMARY .....	4
NOTIFICATION .....	5
1. FACTUAL INFORMATION .....	6
1.1 History of the flight.....	6
1.2 Injuries to persons .....	8
1.3 Damage to aircraft.....	8
1.4 Other damage .....	8
1.5 Personnel information .....	8
1.6 Aircraft information .....	9
1.7 Meteorological information .....	26
1.8 Aids to navigation .....	28
1.9 Communications .....	28
1.10 Aerodrome information .....	29
1.11 Flight recorders .....	29
1.12 The accident site and wreckage information .....	37
1.13 Medical and pathological information .....	47
1.14 Fire .....	47
1.15 Survival aspects .....	47
1.16 Tests and research .....	48
1.17 Organizational and management information.....	67
1.18 Additional information.....	78
1.19 Useful or effective investigation techniques.....	90
2. COMMENTS FROM THE ACCIDENT INVESTIGATION BOARD NORWAY.....	92
2.1 Introduction.....	92
2.2 The accident sequence .....	92
2.3 Technical investigation .....	94
2.4 Safety barriers .....	96
2.5 The G-REDL accident .....	97
3. FURTHER INVESTIGATION .....	100
ABBREVIATIONS .....	101

## AIR ACCIDENT PRELIMINARY REPORT

Type of aircraft:	Airbus Helicopters EC 225 LP Super Puma
Nationality and registration:	Norwegian, LN-OJF
Owner:	Parilease, Paris, France
Operator:	CHC Helikopter Service AS, Norway
Crew:	2, both fatally injured
Passengers:	11, all fatally injured
Accident site:	Storeskitholmen near Turøy, Øygarden municipality, Hordaland county, Norway (60° 27.137 N 004° 55.835 E)
Accident time:	Friday 29 April 2016 at 1155 hrs

All times given in this report are local time (UTC + 2), if not otherwise stated.

### SUMMARY

On 29 April 2016 the main rotor suddenly detached from an Airbus Helicopters EC 225 LP, operated by CHC Helikopter Service AS, enroute from the Gullfaks B platform in the North Sea to Bergen Airport Flesland, Norway. The accident flight was normal until the main rotor separated. The helicopter had just descended from 3,000 ft and had been established in cruise at 140 kt at 2,000 ft for about two minutes when the main rotor detached. There were no warnings before mechanical noise was recorded on the Combined Voice and Flight Data Recorder immediately before the rotor separated. The helicopter impacted on a small island east of Turøy. All 13 persons on board perished.

The investigation has shown that the accident was a result of a fatigue fracture in one of the eight second stage planet gears in the epicyclic module of the main rotor gearbox. The fatigue had its origin in the upper outer race of the bearing (inside of the gear), propagating towards the gear teeth. The crack initiation appears to be a surface micro-pit. However, the reason for formation of the micro-pit and the underlying driving mechanisms are not currently understood, i.e. how and why the cracks continued to grow sub-surface. No material conformity issues or discrepancies in the manufacturing process have been revealed during the investigation.

The main rotor gearbox had been involved in a road accident during transport in 2015. It was inspected, repaired and released for flight by the helicopter manufacturer, Airbus Helicopters. It was installed on LN-OJF in January 2016, 260 flight hours prior to the accident. The AIBN has found no physical evidence that could connect the ground transport accident to the subsequent initiation and growth of the fatigue cracks in the second stage planet gear.

The observed failure mode in this accident, i.e. crack initiation and propagation with limited spalling, seems to differ from what was expected or foreseen during the design and certification of the main rotor gearbox. The fracture propagated in a manner which was unlikely to be detected by the maintenance procedures and the monitoring systems fitted to LN-OJF at the time of the accident. The certification process and Certification Specifications for Large Rotorcraft related to catastrophic failure and requirements for safety barriers will be subject to further investigation.

The investigation has revealed that this accident has clear similarities to an AS 332 L2 accident off the coast of Scotland in 2009 (G-REDL). G-REDL had a near identical main rotor gearbox to the one installed in LN-OJF. In both accidents, one of the eight second stage planet gears in the epicyclic module fractured as a result of fatigue. However, there was one warning of possible gear fracture in the case of G-REDL, while there was no advance warning in this accident (LN-OJF).

In the case of G-REDL, the origin of the crack was in a section of the failed gear which was not recovered. The G-REDL report displayed a stress model prediction of crack growth in the missing section of the planet gear. The crack propagation path in the retrieved second stage planet gear in this accident (LN-OJF) appears to be very similar to the estimated crack growth in the G-REDL.

The AIBN will continue the investigation into how and why two similar catastrophic accidents could happen to near identical helicopters only seven years apart. Further assessment of the follow-up on the G-REDL safety recommendations and the continuing airworthiness of the gearbox after 2009 is a relevant issue.

Due to the scope and complexity of the investigation it is not feasible to estimate a completion date for the final report. The investigation will continue at a high activity level.

## **NOTIFICATION**

The Accident Investigation Board Norway (AIBN) was notified by the Joint Rescue Coordination Center for Southern Norway at 1200 hrs. The first message received was that a helicopter had lost its main rotor near Turøy, and fire and smoke on the ground were observed. Preparations to dispatch a team was initiated immediately. The first team of investigators from the AIBN was at the scene at 1850 hrs.

In accordance with International Civil Aviation Organization (ICAO) Annex 13, Aircraft Accident Investigation, the Bureau d'Enquêtes et d'Analyses (BEA) was notified as the State of design and the State of manufacture. The BEA appointed an Accredited Representative to lead a team of investigators from the BEA and advisors from Airbus Helicopters (the helicopter designer and manufacturer) and Safran (the engine manufacturer). In accordance with Regulation (EU) No. 996/2010 the European Aviation Safety Agency (EASA), the type certifying authority, was notified of the accident and participates as advisor to the AIBN. The Norwegian Civil Aviation Authority (N-CAA) and the Operator CHC Helikopter Service AS were also advisors and part of the team.

The Air Accidents Investigation Branch in the UK (AAIB) had relevant experience from the investigation of the helicopter accident off the coast of Scotland in 2009 with an Airbus Helicopters AS 332 L2, G-REDL. For that reason they were asked to assist during the investigation. The AAIB appointed an Accredited Representative.

Later, the Bundesstelle für Flugunfalluntersuchung (BFU) in Germany was notified as the State of manufacture of some essential components.

# 1. FACTUAL INFORMATION

## 1.1 History of the flight

### 1.1.1 The accident flight

1.1.1.1 On a contractual basis, CHC Helikopter Service AS carried out transportation services for Statoil, including services from Bergen airport Flesland (ENBR) to the Gullfaks oil field in the North Sea.

1.1.1.2 The AIBN has no information that the regular routine was not followed at the day of the accident. The normal check-in time for the crew was 45 minutes before scheduled departure. The crew meet and plan the trip with regard to destination, weather, fuel required and available weight for uploading passengers and cargo. 20 minutes, at the latest, before the scheduled departure time, the pilots carry out exterior and interior inspections of the helicopter. The flights were flown according to standard IFR flight plans.

1.1.1.3 The crew first flew one round trip with LN-OJF (HKS240) that morning. It departed from Flesland at 0702 hrs to the Gullfaks C platform (ENGC) with return to Bergen where the helicopter landed at 0851hrs.

1.1.1.4 The helicopter lifted off from Flesland for the second round trip (HKS241) at 1005. It landed at the Gullfaks B (ENQG) helipad and kept the rotors running while the passengers disembarked and 11 passengers boarded for the inbound flight. The ground stop lasted 12 minutes and LN-OJF lifted off from Gullfaks B at 1116 hrs and climbed to 3,000 ft. The assigned commander was pilot flying (PF) on the return flight towards Flesland.

1.1.1.5 The helicopter maintained cruise altitude of 3,000 ft until shortly before reaching the coast. It then descended to 2,000 ft and flew level at a speed of 140 kt for about two minutes before the main rotor suddenly detached from the helicopter. The main rotor detached above the western end of the Turøy Bridge and it continued to fly on its own in a wide erratic descending left hand turn towards the north.

1.1.1.6 Without its main rotor, the helicopter continued along a steeply descending arc towards the ground where it hit the small island Storeskitholmen. The impact forces destroyed the helicopter, before most of the wreckage slid into the sea. Fuel vapor made a white cloud above the accident site, which immediately ignited and started a fire on the island.

### 1.1.2 Witnesses

1.1.2.1 There were many witnesses to the accident. They were in various locations, some in the immediate vicinity, whereas others were up to two kilometres from the accident site. There is normally considerable helicopter traffic in the area, so people usually do not look up when they hear a helicopter approaching. The reason why so many people witnessed parts of the accident was that they heard a loud noise and therefore looked up toward the helicopter. Because the sound took a while to reach the witnesses, many did not see the helicopter until after the main rotor had separated.

1.1.2.2 The witnesses largely agreed on what they had seen and heard. Many described a loud noise and bang shortly before the main rotor separated. Some described the noise like

thunder or the sound of a gearbox in a car when selecting the wrong gear. One witness explained that it sounded like *'someone riding an old bicycle where the fenders and everything are rattling, just much louder'*. Many described a metallic sound. Several people stated that they had seen yellowish red flames in the area on the top of the helicopter (where the engines are located) after the main rotor had separated. Many people in the vicinity described a series of parts being ejected from that area as the main rotor detached. Many observed the main rotor as it flew off on its own and the main gearbox cowling, which was seemingly suspended in mid-air, before it descended.

1.1.2.3 Many saw the helicopter continue as it rotated once or twice about its longitudinal axis and started on a gradually steeper arc down toward Storeskitholmen. Some explained that the helicopter was rotating in multiple planes. Many people mentioned that they heard the engines rev up and some mentioned that the helicopter wobbled in connection with the rotor detaching. As the helicopter struck the island front first, an explosive fire started immediately.

1.1.2.4 A couple with a four-year-old child were crossing the Turøy Bridge on foot when they heard the helicopter. They estimated they were at about the middle of the bridge when they saw it emerge from the cloud cover west of them. A loud bang was then heard from the helicopter and the rotor detached. The husband stopped, whereas his wife and child continued walking. The helicopter continued virtually straight above the bridge and the husband could see that it was yawing as it moved through the air. He saw dark smoke coming from the helicopter as it continued until striking the island to their southeast. The rotor came straight towards the bridge and was perceived as dangerous until it suddenly changed direction and continued north. Parts fell down around them, and the wife and child hurried toward the end of the bridge. They heard parts hitting rock and falling into the sea.

### 1.1.3 Video recordings

1.1.3.1 A group of eight people associated with a diving school were on a boat at the quay on Turøy about 550 metres from the accident site. They were preparing to dive and two of the divers were equipped with helmet cameras that were filming. The two divers with cameras became aware that something was wrong and looked up. The two helmet cameras captured the helicopter as it fell after the main rotor had detached. The helicopter fell almost horizontally when it entered the upper edge of the camera view. It made a half rotation to the right on its vertical axis and struck the island with the front of the helicopter pointing downward at an angle of approx. 45°. When the helicopter struck the island, the front was pointing in a southwesterly direction and a growing white cloud appeared. The cloud immediately ignited in an explosive fire. The sea became rough and white in the area where parts of the helicopter slid into the sea. A large, black cloud of smoke then billowed up from the area.

1.1.3.2 The two recordings, which are virtually identical, have been made available to the AIBN. Three of the divers immediately boarded a small boat and arrived at the crash site 2-3 minutes after the accident occurred.

1.1.3.3 One video recording was taken by a person who was about one kilometre from the accident site. He saw the helicopter approaching before he heard a metallic sound and the rotor detached. He described it as an *'explosion in the sky'*. The helicopter then fell to the ground and burst into flames. Right after the helicopter hit the ground, he started filming

the rotor, which continued to rotate on its way down to the ground. The recording showed that all five rotor blades were attached to the rotor head, but the relative distance between each blade was not identical. The rotor followed an uneven trajectory until it disappeared out of sight behind a rock.

## 1.2 Injuries to persons

Table 1: Injuries to persons

Injuries	Crew	Passengers	Other
Fatal	2	11	
Serious			
Minor/none			

## 1.3 Damage to aircraft

The helicopter was destroyed. For more information, see chapter 1.12.

## 1.4 Other damage

The helicopter struck Storeskitholmen and a fire started that covered approximately 3,000 m<sup>2</sup> of heather. A warning sign for a power line was damaged by the fire. Small parts of the wreckage, fuel and oil were scattered over a substantial area, both on land and in the sea. There has been considerable effort to remove all the parts, but it is likely that there still are some small pieces of wreckage that were not recovered.

## 1.5 Personnel information

### 1.5.1 The commander

- 1.5.1.1 The commander was 44 years old. He trained as a helicopter pilot in Italy with subsequent assignment at a search and rescue squadron. He was employed as a co-pilot on the Super Puma AS 332 L2 at CHC Helikopter Service in February 2007 and became commander in October 2008. He checked out as commander on the EC 225 LP in January 2015. The commander was an instructor pilot in the company from July 2010.
- 1.5.1.2 The commander had an air transport pilot license for helicopter (ATPL(H)) valid until 31 March 2017 with the following ratings: AS 332 L2 / EC 225 LP, IR(H) ME, TRI(H). The privileges were renewed on 14 January 2016 by OPC/PC. His medical certificate, without limitations, was valid until 16 October 2016.
- 1.5.1.3 The commander's work schedule was five days on duty, two days off duty, followed by five days on duty and nine days off duty. The accident happened during the second round trip on the last working day of a work period. The commander had 13 hours of rest before the duty began.

Table 2: Flying experience commander

Flying experience	All types	On type
Last 24 hours	3:49	3:49
Last 3 days	8	8
Last 30 days	31	31
Last 90 days	74	74
Total	6,100	427



## 1.5.2 The co-pilot

- 1.5.2.1 The co-pilot was 57 years old. He trained as a helicopter pilot at a civilian flying school in the United States before he was employed as co-pilot on Super Puma at CHC Helikopter Service in June 1989. He became a commander in October 2006. The co-pilot checked out as commander on the EC 225 LP in May 2009. He was operative as pilot-in-command on SAR (Search and Rescue operations) on the helicopter type.
- 1.5.2.2 The co-pilot had an air transport pilot license for helicopter (ATPL(H)) valid until 30 June 2016 with the following ratings: AS 332 L2 / EC 225 LP, IR(H) ME. The privileges were renewed on 22 May 2015 by PC. OPC was performed 27 January 2016. His medical certificate, with VNL limitation, was valid until 20 May 2016.
- 1.5.2.3 The co-pilot work schedule was eight days on duty, normally on a rig, then 6 days off duty, then eight days on duty on land, followed by 13 days off. The accident happened during the second round trip on the first working day of a work period. He had two weeks free of duty before the service began.

Table 3: Flying experience co-pilot

Flying experience	All types	On type
Last 24 hours	3:49	3:49
Last 3 days	7	7
Last 30 days	23	23
Last 90 days	45	45
Total	11,184	564

## 1.6 **Aircraft information**

### 1.6.1 General description and background

- 1.6.1.1 The Airbus Helicopters EC 225 LP Super Puma is a twin-engine, medium-size utility helicopter designed for civil use. The CHC Helikopter Service version of the EC 225 LP had seating capacity for a crew of two and 19 passengers.
- 1.6.1.2 The EC 225 LP is a development of the AS 332 L2, which again is a lengthened and modernized version of the original AS 332 helicopter. The main differences between the AS 332 L2 and the EC 225 LP are the five-bladed main rotor, up-rated engines and an increased take-off mass. The AS 332 L2 and EC 225 LP have similar main gearboxes (MGB) with identical epicyclic modules. The prototype EC 225 LP maiden flight took place in 2000 and the first production version flew in 2004. After Eurocopter was rebranded Airbus Helicopters in 2014, the EC 225 LP has also been referred to as the H225. The report will normally refer to the company as Airbus Helicopters even for the period prior to 2014.
- 1.6.1.3 According to Airbus Helicopters<sup>1</sup>, the Super Puma family of helicopters (starting with the AS 332) has accumulated more than 5.4 million flight hours. The EC 225 LP fleet (including the military variant H225 M and EC 725 AP) consists of nearly 270 delivered helicopters, which by the end of 2016, had accumulated approximately 590,100 flight hours. More than 35 operators in 25 countries operate the EC 225 LP helicopters. At the

<sup>1</sup> [http://www.airbushelicopters.com/website/en/ref/H225\\_40.html](http://www.airbushelicopters.com/website/en/ref/H225_40.html) (29 November 2016)

time of the accident, approximately 25 % of the EC 225 LP fleet was serving the oil and gas industry in the North Sea.



Figure 1: LN-OJF. Photo: CHC Helikopter Service

#### 1.6.2 Leading particulars

Manufacturer:	Airbus Helicopters
Type:	EC 225 LP
Serial Number:	2721
Year of manufacture:	2009
Powerplants:	Two Turbomeca Makila 2A1 turboshaft engines
Total airframe hours:	5,711:05 hrs
Total hours main gearbox:	1,340 hrs
Certificate of Airworthiness:	No. 2009-0992, issued 28 August 2009 by the Norwegian CAA



stops and droop retainers. The main rotor head and main rotor shaft is one piece. The rotor carries the weight of the helicopter via the lift bearing attached to the main rotor shaft. The lift bearing is located inside the lift housing which is attached to the conical housing on top of the MGB. The lift forces are transferred to the helicopter fuselage (transmission deck) via three suspension bars which are connected both to the lift housing and to fittings on the fuselage (see chapter 1.6.7.1).

#### 1.6.6 Flying controls

Control inputs to change the main rotor blade pitch from the cyclic control, and the collective control, are transmitted from the cockpit via the auxiliary servo (auto pilot) to three hydraulic actuators mounted on the lower section of the MGB. These transmit control inputs to a non-rotating swash plate located immediately below the rotor head. Movement of the non-rotating swash plate results in a corresponding movement of the rotating swash plate and via pitch links to a change in main rotor blade pitch. Hydraulic power for the actuators is provided by two independent hydraulic circuits. In addition there is a back-up system with an auxiliary hydraulic pump.

#### 1.6.7 Main Rotor Gearbox (MGB)

##### 1.6.7.1 *General*

The MGB installed in LN-OJF had part number 332A32-5003-01M and serial number M5165. At the time of the accident it had accumulated 1,340 hrs since new.

The MGB is split into two main sections:

- The lower section, referred to as the main module, reduces the input shaft speed from the two engines from around 23,000 rpm to around 2,400 rpm.
- The epicyclic reduction gearbox module bolted on top of the main module (see Figure 3). This reduces the rotational speed of the output from the main module to 265 rpm during cruise and 275 rpm when the airspeed is below 40 kt.

A conical housing made from aluminum is bolted on top of the epicyclic gearbox (Figure 3). A lift housing made from titanium is bolted on the top of the conical housing. The lift housing holds the lift bearing, the main rotor drive shaft and the main rotor head.

The MGB assembly is attached to the transmission deck/cabin ceiling via the three suspension bars and a flexible mounting plate. The flexible mounting plate is bolted to the bottom of the main module and the transmission deck. It transmits the generated torque from the MGB to the airframe and also stabilizes the MGB.

The suspension bars (lift struts) are attached with clevis pins at each end. Each clevis pin is secured with two safety pins. On the upper end the clevis pins are attached to lugs on the lift housing. On the lower end the clevis pins are attached to the strut fittings (fuselage fittings) which are bolted to the transmission deck with four bolts each. The suspension bars transmit the lift loads generated by the rotor system to the transmission deck (see Figure 2).

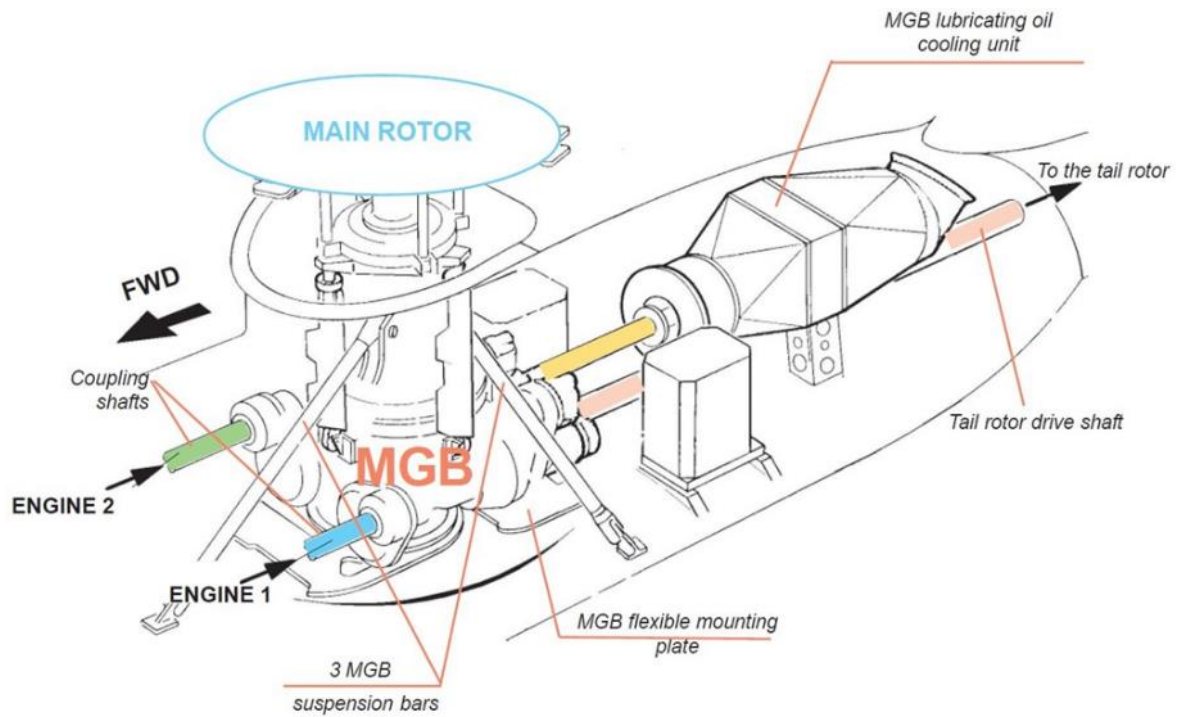

Figure 2: Transmission layout diagram. Source: Airbus Helicopters

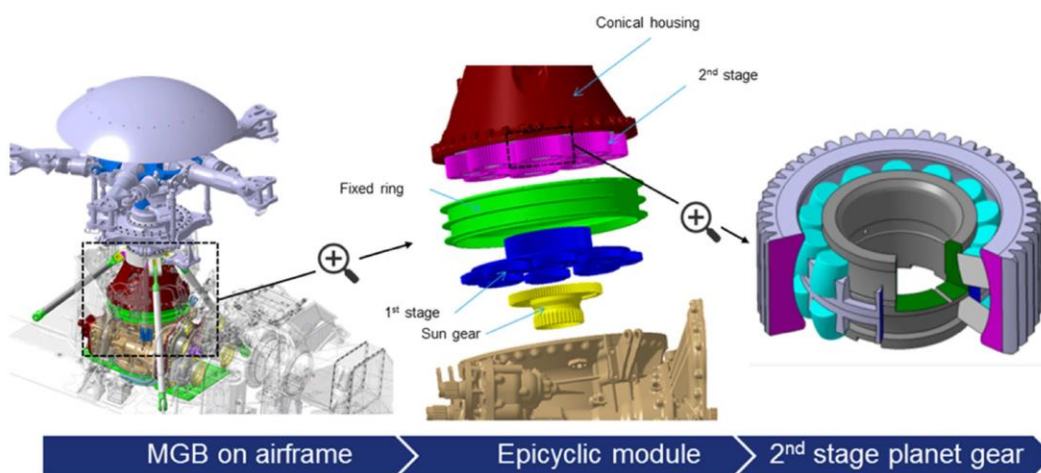

Figure 3: Illustration of the MGB installation, exploded view of epicyclic module and one second stage planet gear. Main module shown in light brown. Conical housing shown in dark red. Source: Airbus Helicopters

### 1.6.7.2 The main module

Power output from both engines is transmitted to the main module of the MGB through the left and right reduction gearboxes, mounted on the front of the main module. These reduce the rotational speed of the input drive from 23,000 rpm to 8,011 rpm. The output from the left and right reduction gearboxes provides power to the left and right accessory modules respectively and is combined by the combiner gear within the main module (see Figure 4). This combined drive provides power to the tail rotor drive shaft and the bevel gear. The bevel gear reduces the rotational speed of the input drive to 2,405 rpm and changes the combined input into the vertical plane to drive the epicyclic reduction gearbox module.



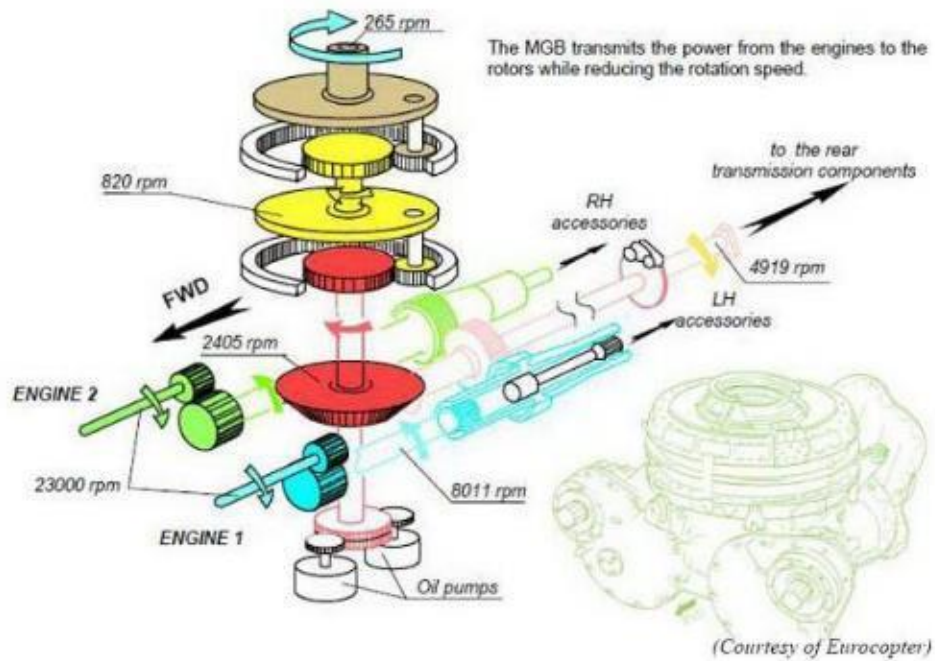

Figure 4: Main Rotor Gearbox dynamic components. Source: Airbus Helicopters

### 1.6.7.3 Epicyclic module

Drive from the main module is transmitted via the first stage sun gear (see Figure 5). This drives eight first stage planet gears, contained by the first stage ring gear and mounted on stub shafts on the first stage planet carrier. The upper section of the first stage planet carrier consists of the second stage sun gear. This drives eight second stage planet gears, contained by the second stage ring gear and mounted on stub shafts on the second stage planet carrier, which then turns the main rotor drive shaft through a splined coupling. The first stage and second stage ring gear consists of one single machined component.

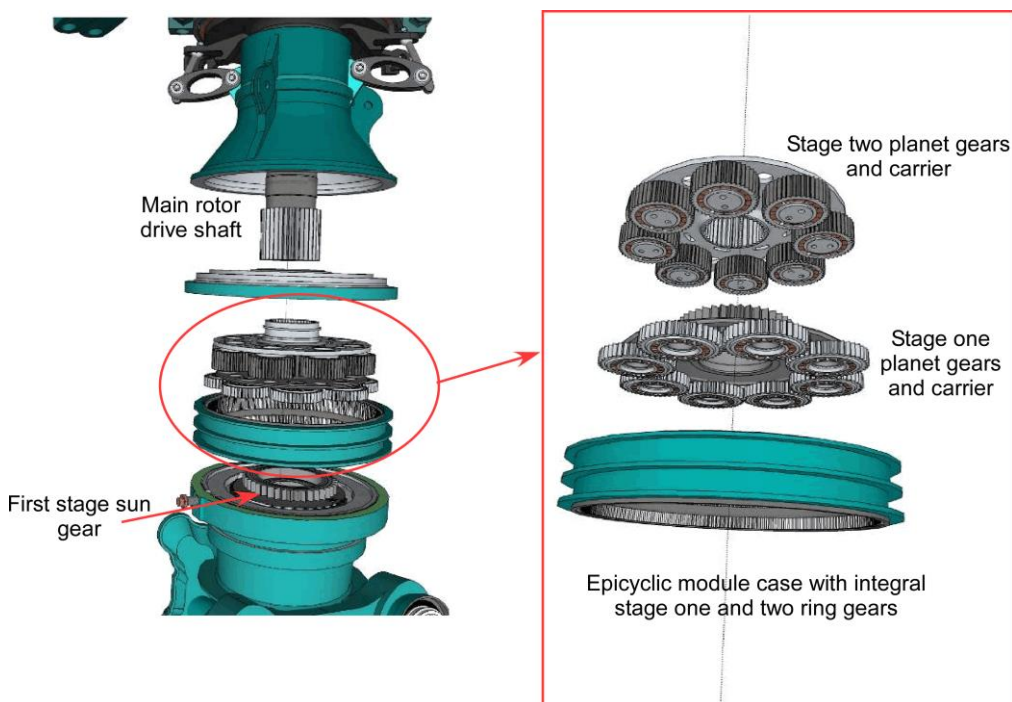
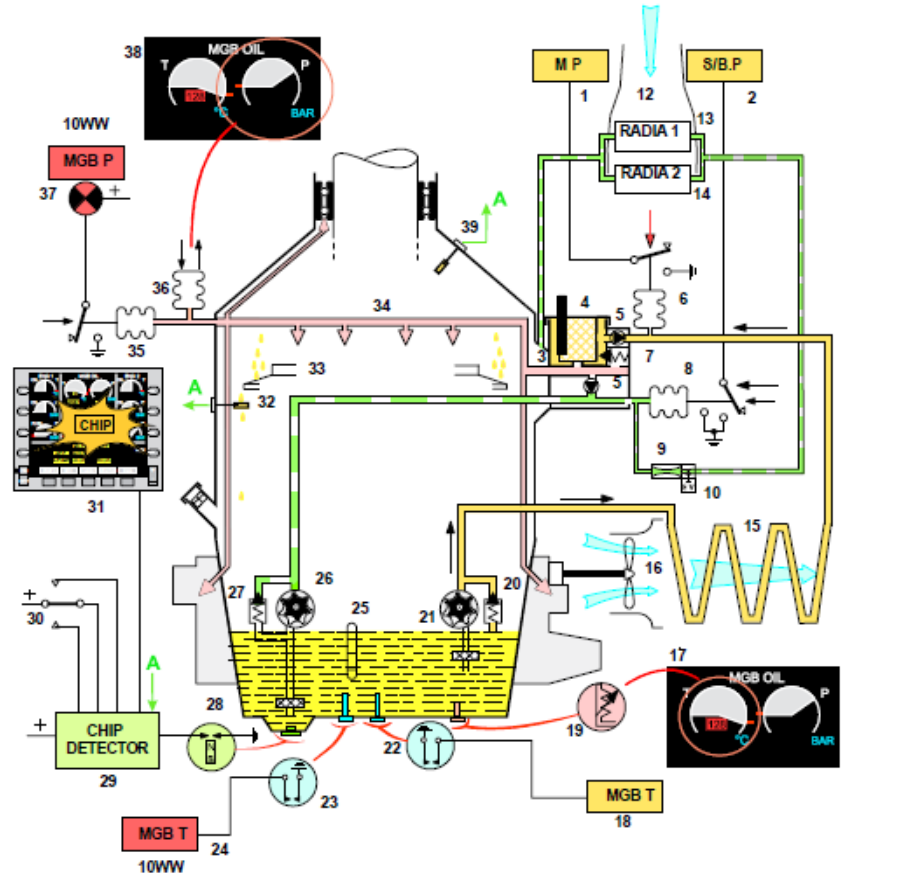

Figure 5: Layout of the epicyclic reduction gearbox. Source: Airbus Helicopters

1.6.7.4 Main rotor gearbox oil system

Lubrication for the MGB is provided by a primary and a standby oil pump, see Figure 6. Oil from the primary pump travels through the gearbox oil cooler, before passing through a 25 micron filter. The filtered oil is provided to all of the internal components within the gearbox through internal galleries.



- |   |   |
|---|---|
| <ul style="list-style-type: none"> <li>1 - Cautionary indication on VMS (P&lt;3.7 bars)</li> <li>2 - Cautionary "Stand-by low pressure" indication on VMS (2 thresholds: P&lt; 2.6 bars or P&lt; 1 bar)</li> <li>3 - Return line trough the endoscope cap</li> <li>4 - Oil filter (filtration capacity 25 µ) with clogging indicator</li> <li>5 - Check valves (set to 0.1 bar)</li> <li>6 - Pressure switch (P&lt;3.7 bars)</li> <li>7 - Filter bypass, Δ P 8 bars (opens in the event of clogging)</li> <li>8 - Dual threshold pressure switch (P&lt; 2.6 bars or P&lt; 1 bar)</li> <li>9 - Flow divider part</li> <li>10 - Electro-valve</li> <li>11 - Dynamic air scoop</li> <li>12 - Air duct</li> <li>13 - Cooler type 2</li> <li>14 - Cooler type 1</li> <li>15 - "Oil-to-air" heat exchanger</li> <li>16 - MGB driven fan</li> <li>17 - Oil temperature indicator on VMS</li> <li>18 - Cautionary "excessive oil temperature" indication</li> <li>19 - Oil temperature probe</li> </ul> | <ul style="list-style-type: none"> <li>20 - Pressure relief valve set to 10 bars</li> <li>21 - Main oil pump</li> <li>22 - Oil temperature thermo-switch</li> <li>23 - Excessive oil temperature thermo-switch</li> <li>24 - Excessive oil temperature red warning light on 10WW</li> <li>25 - Oil level sight</li> <li>26 - Stand-by oil pump</li> <li>27 - Pressure relief valve set to 3.3 bars</li> <li>28 - Sump magnetic chip detector</li> <li>29 - Chip detection and destruction unit</li> <li>30 - Chip destruction switch</li> <li>31 - Cautionary indication (on VMS): metallic chips</li> <li>32 - Epicyclic magnetic chip detector</li> <li>33 - Oil deflector (prevents pollution due to particles)</li> <li>34 - Lubrication diffuser</li> <li>35 - Pressure switch (P&lt;0.4 bars)</li> <li>36 - Oil pressure transmitter</li> <li>37 - MGB Oil pressure drop red warning light on 10WW panel (the MGB is no longer lubricated)</li> <li>38 - Oil pressure indicator on the VMS</li> <li>39 - Mast magnetic chip detector</li> </ul> |
|---|---|

Figure 6: Schematic of EC225 LP MGB lubrication system. Source: Airbus Helicopters

## 1.6.8 The second stage planet gear

### 1.6.8.1 *General description*

The epicyclic module planet gears are designed as a combined gear and bearing assembly (see Figure 8)<sup>3</sup>. The outer race (OR) of the bearing and the gear wheel are a single component, with the bearing rollers running directly on the inner circumference of the gear. The gear wheel of the planet gear has a total of 51 gear teeth. The remainder of the assembly consists of an inner race (IR), two sets of 14 roller bearings (upper and lower), and two bearing cages. Each planet gear is 'self-aligning' by the use of spherical outer races and barrel shaped bearing rollers. The geometry of the bearing rollers is such that, when rolling, the linear velocity of the surface of the bearing varies along its rotational axis. This means that some sliding of the bearing rollers on raceways will occur.

The planet gears/outer races are manufactured from 16NCD13 steel, the bearing rollers and inner races from M50 steel.

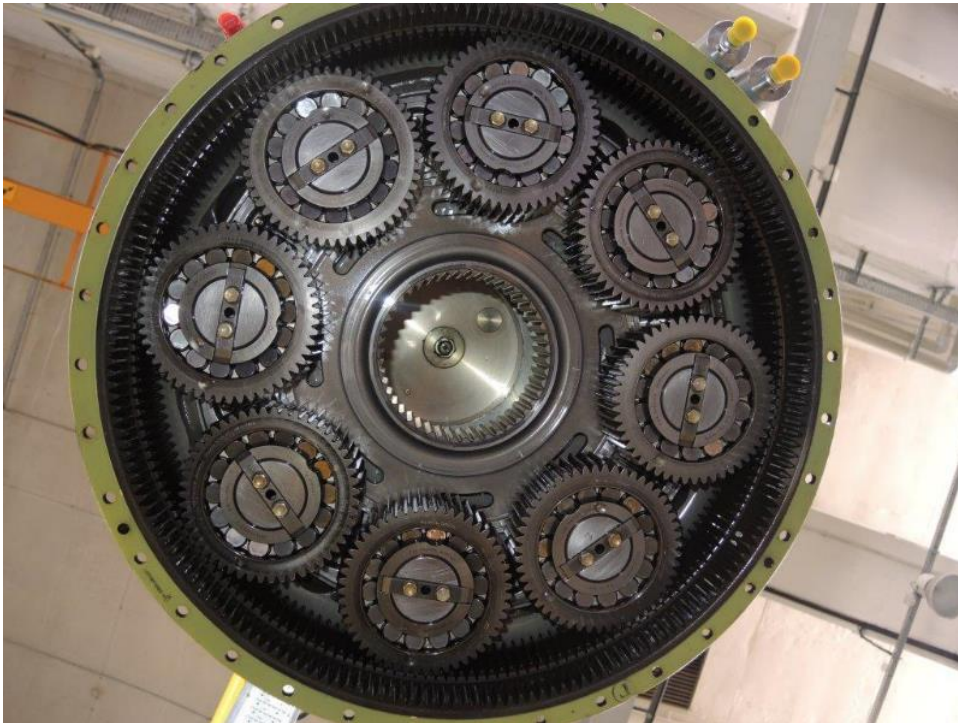

*Figure 7: Eight second stage planet gears as fitted on the carrier inside the ring gear, seen from below (first stage gears and carrier is not shown). Photo: AIBN*

---

<sup>3</sup> This assembly of gear and bearing is referred to as the gear if not otherwise specifically mentioned separately as bearing or gear wheel.



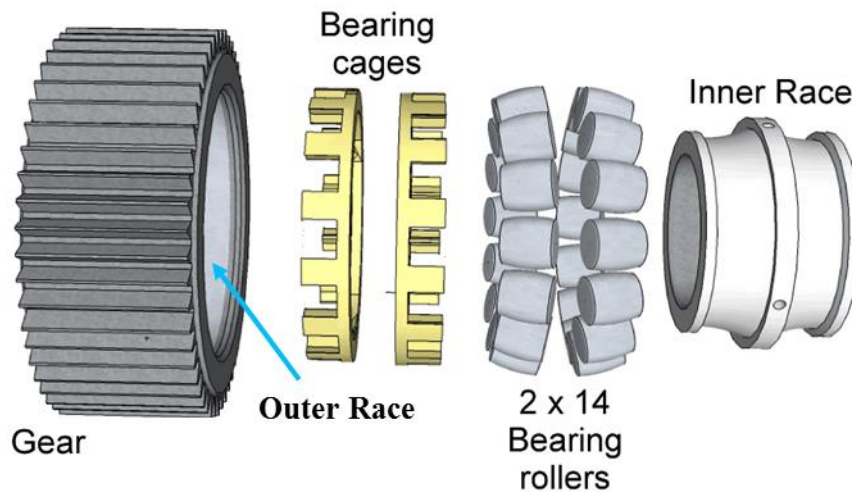

Figure 8: Planet gear configuration. Source: Adapted from the AAIB / G-REDL report

The use of M50 steel in bearings is common within the aviation industry and its properties and performance are understood. However, its through-thickness hardness makes it unsuitable for use as a gear, where it would be exposed to repetitive bending loads. The properties of 16NCD13 steel make it more suitable for use in the manufacture of gears; however, it is less suitable as a bearing surface facing rollers of M50 steel without modifications.

In order to improve the cyclic load bearing characteristics of 16NCD13 steel, after initial manufacturing and finishing, the gear wheel undergoes a carburization process. This involves immersing the component in a carbon-rich atmosphere which results in carbon atoms diffusing into the surface. The depth of the carburization is dependent on the temperature, carbon concentration, steel microstructure and duration of the process. It is specified for the second stage planet gear to be between 0.85 mm and 1.45 mm into the body of the material. The average thickness is around 1.2 mm.

The process has two significant effects, firstly it hardens the exposed material, making it more suitable for use in bearing applications and secondly, it introduces a layer of residual compressive stresses at, and close to the surface of the gear wheel. This second effect is particularly desirable for the bearing outer race area as it means that if any damage occurs at or within the carburized layer, the compressive stresses should prevent or limit the damage from progressing into the body of the gear.

The gear wheel is carburized and finished by Airbus Helicopters with the exception of the bearing outer race surface, which is only partially finished. This is then matched with an inner race, a set of roller bearings and the cage from sub-suppliers (see chapter 1.6.8.3).

#### 1.6.8.2 Planet gear development

The design of the second stage planet gear used in the AS 332 L2 and the EC 225 LP took advantage of a significant amount of in-service and design experience from earlier AS 332 L1 and SA 330 Puma helicopter gearboxes.

In 1986 Airbus Helicopters invited two bearing manufacturers, FAG and SNR, to supply planet gear bearings for the new gearbox for the AS 332 L2. The invitation specified a number of criteria. One such criterion was that it should be based on the existing design

used in the AS 365 Dauphin gearbox, a gear already produced by FAG. The new epicyclic module in the AS 332 L2 had an architecture based on the AS 332 L1, but was fitted with 8 planet gears instead of the previous 9, while the diameter of each gear increased. Specifically, the focus was on limiting spalling on the inner raceway, as this had been a problem with the AS 332 L1. L10 life<sup>4</sup> was not specified by Airbus Helicopters, but according to Airbus Helicopters it was included in the proposals from the suppliers. The specific proposals from the suppliers are unknown to this investigation as Airbus Helicopters has not been able to retrieve the documentation.

In 2000 Airbus Helicopters requested FAG and SNR to develop planet gears for the EC 225 LP. The AIBN has been shown the suggested solutions from both suppliers and the results of their L10 life calculations. The L10 life calculations provided by FAG were significantly lower than those calculated by SNR. It was not possible to establish whether both manufacturers used the same basis for their calculations.

According to Airbus Helicopters, at that time, they assessed neither the differences in L10 life nor the other calculations provided by the suppliers. For industrial reasons, the aim was to have two suppliers which both satisfied the design limitations. L10 life (spalling) was regarded as a reliability issue, not a primary safety issue. The planet gear itself was regarded as a critical part, i.e. a failure would be catastrophic.

The ultimate life of the gear, which was not required to account for operational wear, was based on a fatigue failure of a gear tooth. Calculations showed that, in this case, the gear would have an unlimited life. As a result of the helicopter manufacturer's experience of in-service mechanical wear with earlier AS 332 and SA 330 variants, the planet gear assembly was given an operational life of 6,600 flying hours in the AS 332 L2 and 4,400 flying hours in the EC 225 LP.

#### 1.6.8.3 *Planet gear design and manufacturing workshare*

The second stage planet gear is defined as a critical part (see chapter 1.17.6.3 and CS 29.602). The planet gear wheel without the bearing, including its rim and teeth, is designed and manufactured by Airbus Helicopters. The planet gear bearings were manufactured by FAG and SNR respectively following a Build to Specification process approved by Airbus Helicopters.

Because the outer race of the planet gear bearing is integrated into the planet gear, a specific workshare is established between Airbus Helicopters and the bearing manufacturers. This workshare covers each phase of the design, the substantiation and the manufacturing process of the planet gear bearing.

The design characteristics of the bearing inner race, rollers, cage and outer race finishing process are usually proposed by the bearing suppliers. Airbus Helicopters manufactures the planet gear wheel including the outer race and provides it to the bearing supplier with a partly finished bearing outer race surface. The supplier manufactures the bearing and performs the grinding of the planet gear outer race. Then, the supplier assembles the bearing and the planet gear wheels.

---

<sup>4</sup> The L10 is a calculation that gives a theoretical life, at which ten percent of the bearings population can be expected to have failed due to fatigue under clean ideal operating conditions. The L10 equation commonly cited in the literature has been empirically derived.

The completely assembled planet gear including the bearing is supplied to Airbus Helicopters. The gears manufactured by FAG were given part number 332A32-3335-07 and gears manufactured by SNR part number 332A32-3335-06. Airbus Helicopters had approved that gears from both FAG and SNR could be mixed on a second stage planet gear carrier.

On LN-OJF all the planet gear bearings were manufactured by FAG. The AIBN has visited FAG and received information about the design principles and manufacturing process. FAG informed that the production process has been approved by Airbus Helicopters and has been frozen and unchanged since the beginning of production. FAG informed that together with Airbus Helicopters, they had reviewed the bearing calculation after the LN-OJF accident. They found no discrepancies from the initial calculations and the approvals from Airbus Helicopters. Further, an internal quality review confirmed that there were no deviations in the manufacturing process.

According to Airbus Helicopters the key driving factors in a planet gear bearing are the following:

- Rolling kinematics
- Load applied on the planet gear bearing
- Hertz pressure on the contact between rolling element and inner/outer races
- Stiffness of the outer race and gear rim.<sup>5</sup>

Figure 9 shows the differences between a FAG and a SNR bearing and their contact pattern on outer race. Table 5 shows the contact pressure for FAG and SNR second stage planet gear bearings, with FAG having a significantly higher contact pressure on the outer race (OR). In addition, the differences in the finishing process performed by the suppliers can affect the outer race surface residual stress, with FAG having a significantly higher compressive stress at the race surface.

*Table 5: Contact pressure calculated by the suppliers for EC 225 LP second stage planet gear bearing. Source: Airbus Helicopters*

Contact pressure at take-off-power transient	FAG	SNR	Key difference
IR max contact pressure [MPa]	1,811	1,862	FAG IR contact pressure = 0.97 x SNR
OR max contact pressure [MPa]	1,800	1,550	FAG OR contact pressure = 1.16 x SNR

<sup>5</sup> 'Gear rim' is the body of the gear between the tooth root and the outer race.

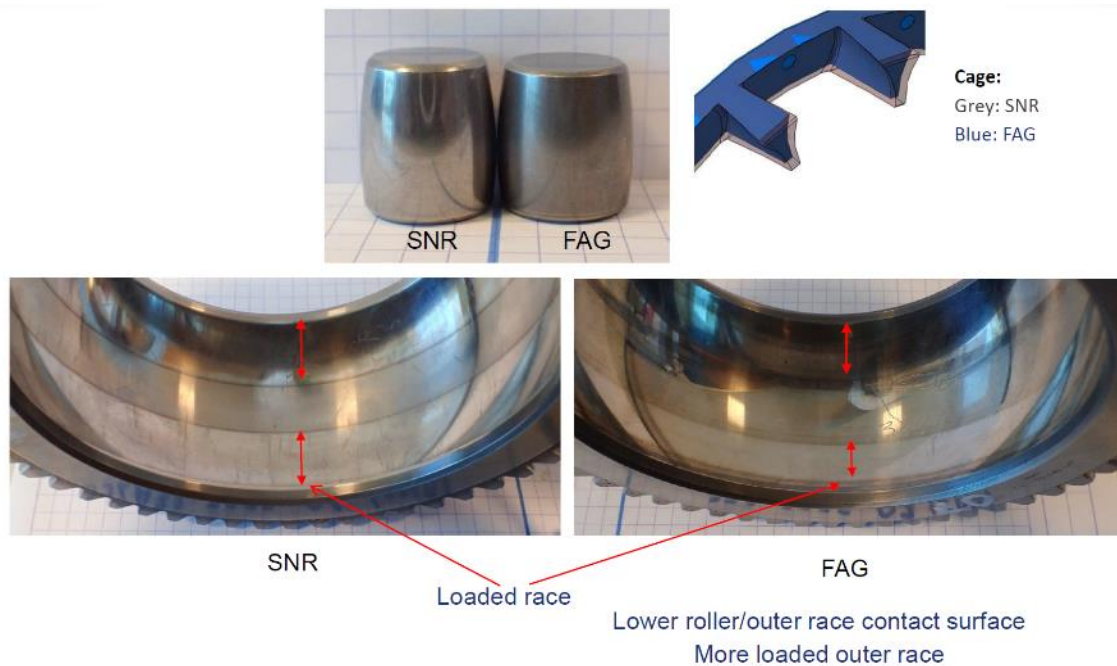

Figure 9: Differences between SNR and FAG bearings and contact pattern on outer race. Source: Airbus Helicopters

1.6.9 Main gearbox condition monitoring

The EC 225 LP is provided with a chip detection system. The chip detectors are designed to detect and retain chips of magnetic material shed, for example, from the gears or their bearings. Figure 10 shows the chip detection system overview.

For the EC 225 LP, the mast bearing chip detector, the epicyclic module chip detector and the sump chip detector are connected to a flight crew warning circuit. Thus, a visual warning to the flight crew is provided when one particle of sufficient size or a sufficient cumulative quantity of particles, bridge the axial gap of the magnetic plug (see Figure 11). The oil cooler chip detector is not connected to any warning system and must be inspected visually.

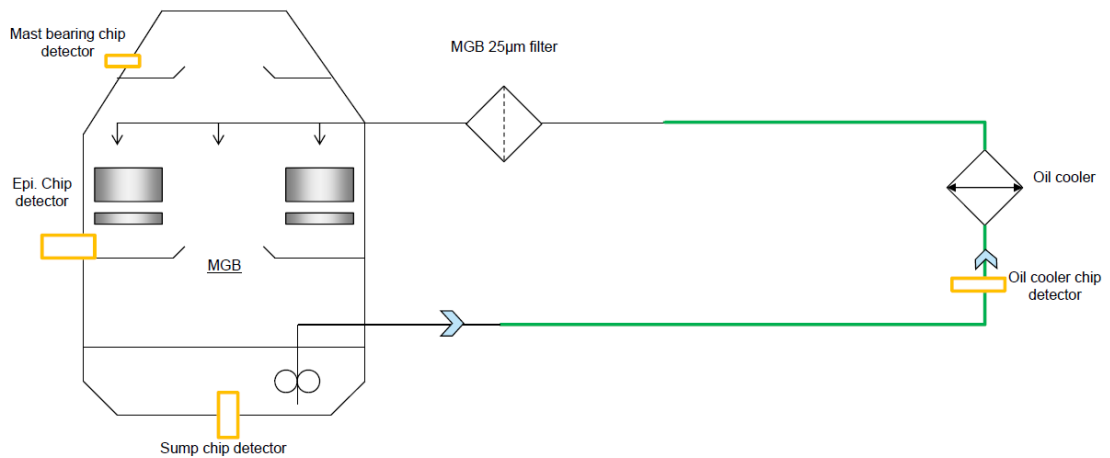

Figure 10: Chip detection system overview. Source: Airbus Helicopters

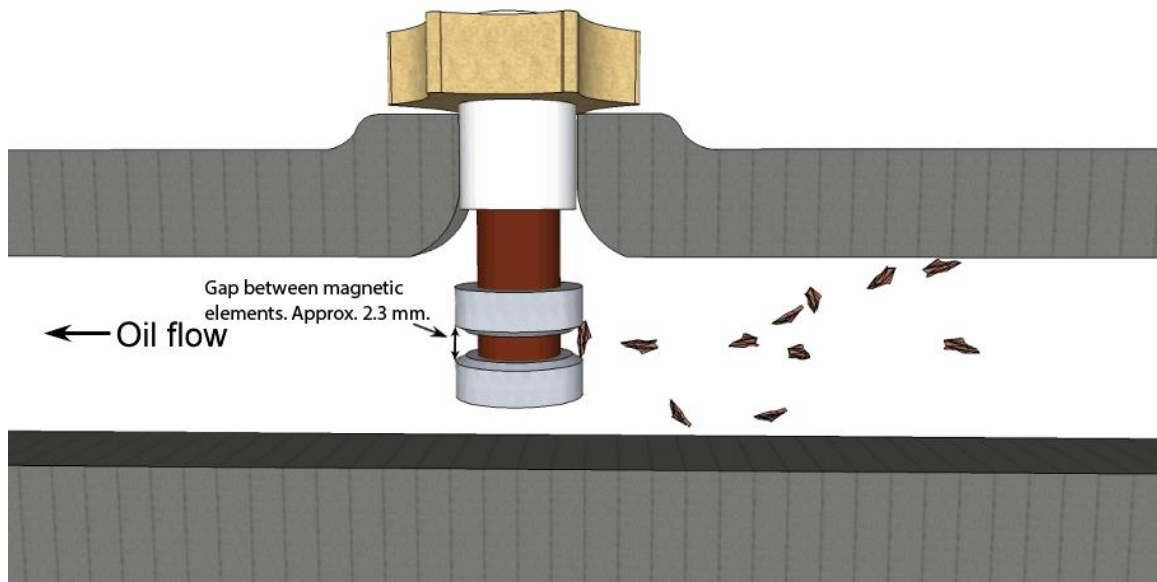

Figure 11: Generic diagram of a manual magnetic chip detector.

Source: Adapted from the AAIB / G-REDL report

After the G-REDL accident (see chapter 1.18.3) the following measures were implemented in order to improve the chip detection of the epicyclic module:

1. Removal of the epicyclic module magnets. The oil collector under the epicyclic module was equipped with magnets in order to trap particles coming from the epicyclic module and preventing magnetic debris from the epicyclic module to pollute the main module. It was thought that these magnets prevented particles from entering the chip detectors and thus reduced the efficiency of the chip detection system.
2. Recommended connection of the epicyclic module chip detector to the crew warning circuit for AS 332 L2. On the EC 225 LP the epicyclic module chip detector was already connected to the warning circuit as part of the type design.
3. Standardized reduction of chip detectors visual inspection intervals.
4. Revised removal criteria for the MGB following collection of particles. At the time of LN-OJF accident, the criteria for MGB removal was accumulated 50 mm<sup>2</sup> of metal particles or a 0.4 mm particle thickness or a 2 mm length particle or 2 mm<sup>2</sup> surface particle of dedicated material (ref. Airbus Helicopters Safety Information Notice (SIN) 2075-S-63).

Airbus Helicopters launched a MGB spalling test program following the G-REDL accident (see chapter 1.18.3). The single test, presented to the AIBN, has shown that the total detection rate (% of all free magnetic particles expected to be collected on the plugs) is 12 %, while 44 % of the particles were said to end up in the oil filter. However, due to the recent finding of several particles recovered from inside the oil cooler of LN-OJF (see chapter 1.16.8.3), Figure 12 is no longer representative. 44 % of the particles do not reach the MGB oil filter like the figure shows, but particles are actually also collected by the oil cooler.

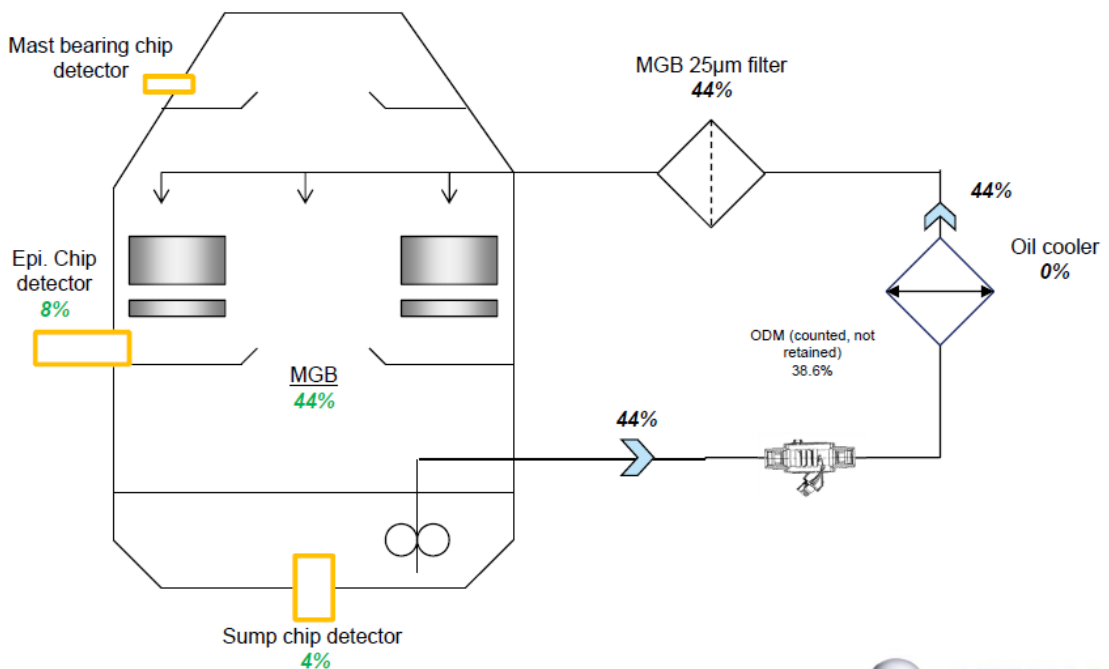

Figure 12: The test set-up and the detection rate of chip detectors (%: Particle quantity) presented following the G-REDL MGB spalling test program. Source: Airbus Helicopters

### 1.6.10 Maintenance information

#### 1.6.10.1 General

The maintenance performed by CHC Helikopter Service was based on the company’s Aircraft Maintenance Program (AMP). The intention of the AMP is to define the maintenance actions required in order to maintain the serviceability and the continuing airworthiness of the aircraft and the aircraft components. The AMP was approved by CAA-N and based on the maintenance recommendations published by the Type Certificate Holder (Airbus Helicopters), optional equipment manufacturers and the certifying agencies, which must be acceptable to EASA.

The AMP that was valid for LN-OJF was based on the latest issue of the Airbus Helicopters Master Servicing Manual that also contains the Airworthiness Limitations Section (MSM/ALS) and Turbomeca Maintenance Manual, Chapter 5. The latest revision of the (AMP) was dated 5 November 2014. Airbus Helicopters describes specific maintenance tasks (MMA) in Maintenance Manuals. The maintenance program defines a Time Between Overhaul of MGB and the overhaul work-cards define a series of maintenance operation and rejection / replacement / repair criteria for the MGB parts.

#### 1.6.10.2 Maintenance production documents in CHC Helikopter Service

The maintenance activities given in the AMP consist of recurring activities with given intervals. Thereby, for example, a 500 hrs inspection consists of all activities with an inspection frequency of 500 hrs. In addition, components close to life expiry, manufacturer service bulletins and airworthiness directives issued by aviation authorities (SB/AD) and deferred defects that are due near a planned inspection, will naturally be grouped together with the scheduled maintenance activities. In CHC Helikopter Service all work planned on a scheduled inspection is grouped into a Work Package. The Work

Package consists of Work Orders describing each maintenance activity, component replacement, SB/AD and defects that are grouped together.

#### 1.6.10.3 *Performed maintenance related to the Main Gearbox and Main Rotor Gearbox installation*

The main gearbox serial number (S/N) M5165 was initially installed in another CHC helicopter with S/N 2794, but was removed for a bevel gear shaft modification. This modification was initiated following the two EC 225 LP ditchings in the North Sea in 2012 (see chapter 1.18.5). The MGB was later scheduled for installation in another CHC helicopter in Australia. During road transport on a small truck the MGB was damaged and returned to Airbus Helicopters for repair (see chapter 1.6.10.4).

24 January 2016: Following repair by Airbus Helicopters, the MGB S/N M5165 was installed in LN-OJF. The MGB had accumulated 1,080 hrs since new. The installation work involved transfer of the main rotor head from the removed MGB to the MGB that was about to be installed. During this work, it was discovered that the suspension bar forward support plate 332A22-1667-22 was worn beyond allowable limits. This involved the removal of the forward suspension bar fitting. All four bolts P/N 332A22-1613-21 were replaced with new bolts during reinstallation of the forward suspension bar fitting (A/C total time 5,450:21 hrs, 260:44 flight hours prior to the accident).

1 February 2016: MGB oil change in accordance with MMA 60-00-00-641 (A/C total time 5,477:51 hrs, 233:14 flight hours prior to the accident).

4 February 2016: Visual inspection of MGB chip detectors in accordance with the AMP (MMA 60-00-00-212). There were no findings of magnetic debris on the detectors (A/C total time 5,489:33 hrs, 221:32 flight hours prior to the accident).

9 February 2016: Detailed visual external inspection of MGB suspension bars in accordance with MMA 63-32-00-211 (A/C total time 5,504:34 hrs, 206:31 flight hours prior to the accident).

16 February 2016: Visual inspection of MGB chip detectors in accordance with the AMP (MMA 60-00-00-212). There were no findings of magnetic debris on the detectors (A/C total time 5,529:05 hrs, 182:00 flight hours prior to the accident).

22 February 2016: Re-torque of MGB flexible mounting plate in accordance with MMA 63-20-00.213-002 (A/C total time 5,546:06 hrs, 164:59 flight hours prior to the accident).

28 February 2016: Detailed visual inspection of MGB oil filter element in accordance with MMA 63-24-01-061. There were no findings of magnetic debris in the filter (A/C total time 5,546:29 hrs, 164:36 flight hours prior to the accident).

10 March 2016: Visual inspection of MGB chip detectors in accordance with the AMP (MMA 60-00-00-212). There were no findings of magnetic debris on the detectors (A/C total time 5,574:01 hrs, 137:04 flight hours prior to the accident).

15 March 2016: Detailed visual external inspection of MGB suspension bars in accordance with MMA 63-32-00-211 (A/C total time 5,589:29 hrs, 121:36 flight hours prior to the accident).

29 March 2016: Several maintenance tasks related to external visual inspection of the MGB were performed. The main rotor head was replaced due to axial play between the swashplate lower cup and ball joint. The play was 0.11 mm over limit. Two suspension bar upper clevis pins (lift housing pins) and one suspension bar lower clevis pin were replaced due to corrosion in connection with this work. Visual inspection of MGB chip detectors in accordance with the AMP (MMA 60-00-00-212) was performed. There were no findings of magnetic debris on the detectors (A/C total time 5,610:47 hrs, 100:18 flight hours prior to the accident).

11 April 2016: Visual inspection of MGB chip detectors in accordance with the AMP (MMA 60-00-00-212). There were no findings of magnetic debris on the detectors (A/C total time 5,655:55 hrs, 55:10 flight hours prior to the accident).

21 April 2016: Detailed visual external inspection of MGB suspension bars in accordance with MMA 63-32-00-211 (A/C total time 5,685:12 hrs, 25:53 flight hours prior to the accident).

25 April 2016: Visual inspection of MGB chip detectors in accordance with the AMP (MMA 60-00-00-212). There were no findings of magnetic debris on the detectors (A/C total time 5,695:43 hrs, 15:22 flight hours prior to the accident).

27 April 2016: Detailed visual external inspection of MGB suspension bars in accordance with MMA 63-32-00-211 (A/C total time 5,699:23 hrs, 11:42 flight hours prior to the accident).

29 April 2016 at 0100 hrs: Daily Maintenance Check (A/C total time 5,707:48 hrs, 3:17 flight hours prior to the accident).

29 April 2016 at 0915 hrs: The crew performed the Pre Flight Check.

#### 1.6.10.4 *Ground transport accident to MGB S/N M5165*

The MGB was involved in a road accident in Australia at 13 March 2015. The gearbox was transported by road on a small truck, installed in an original Airbus Helicopters MGB transport container. The truck went off the gravel road trying to avoid kangaroos crossing the road, the truck rolled over and the gearbox container fell off. There was visible damage to external parts of the gearbox.

The gearbox was returned to Airbus Helicopters in Marignane, France for inspection and repair. The damage was assessed by the Part 145 organization and a repair program initiated. It involved replacement of damaged external parts, NDT inspection of the MGB casing and removal of bearings and gears for visual inspection. No anomalies on internal components were detected, and all bearings and gears were re-installed.

The repair was performed by the Part 145 organization. According to Airbus Helicopters' representatives there were minor deviations mainly linked to the formalization of the work done through the documentation with the MGB damage assessment and instruction related to the work without any consequence on the repair. The MGB was supplied with an EASA Form 1 (see chapter 1.17.5.5).





Figure 13: MGB in transport container after the transport accident. Photo: Airbus Helicopters

#### 1.6.11 In-service experience

- 1.6.11.1 In accordance with the requirements of Commission Regulation (EU) No 748/2012, Annex 1 (Part 21) (see chapter 1.17.5.5), Airbus Helicopters is obliged to operate a Continued Airworthiness program to investigate and analyze component failures which may have had an adverse effect on the continuing airworthiness of its products.
- 1.6.11.2 The AIBN has been informed that Airbus Helicopters document in-service planet gear spalling events through In-Service Incident Reports (ISIR). Following the accident, Airbus Helicopters has assessed the in-service experience of gears supplied by FAG and SNR respectively in the 2001 – 2016 period on the Super Puma AS 332 L2 / EC 225 LP / EC 725 fleet. In particular, all spalling events (inner race (IR) / outer race (OR) / rolling elements (RE)) have been recorded. According to Airbus Helicopters, there are more spalling events on FAG planet gears than SNR (see Table 6). During the period considered, the distribution of fitted planet gears in the Super Puma fleet is 53 % for FAG and 47 % for SNR respectively.
- 1.6.11.3 During the AAIB's investigation into the G-REDL accident in 2009 (see chapter 1.18.3) it was found that planet gears which had been rejected for spalling were not routinely routed to the laboratory for additional investigation. The explanation was that when the Continued Airworthiness program for the AS 332 L2 was initiated it was determined, based on previous operational history, design calculations and the maintenance program requirements, that damage to the planet gear outer race would not adversely affect the continued airworthiness of the helicopter. Based on this finding, the AAIB made three safety recommendations (SR 2011-033 to Airbus Helicopters, SR 2011-034 to EASA and SR 2011-035 to the FAA) regarding the evaluation of defective parts (see chapter 1.18.4.3).

- 1.6.11.4 Both the fractured second stage planet gear from G-REDL and the gear from LN-OJF were supplied by FAG (see Table 6). During the G-REDL investigation, neither AAIB nor EASA were made aware of the differences, as described in chapter 1.6.8.3, between the two planet gear configurations. According to Airbus Helicopters, they did not regard the performance of the planet gears as a significant safety factor at the time (see also chapter 1.18.4.7).

Table 6: Summarized chart of in-service incident reports and usage data. Source: Airbus Helicopters

Aircraft	FAG)		SNR	
	AS 332 L2	EC 225 LP	AS 332 L2	EC 225 LP
Case of inner race (IR) spalling	9	7	3	2
Case of outer race (OR) spalling	2 (+G-REDL)	2 (+LN-OJF)	2	0
Cases of OR spalling without IR spalling first	1 (+G-REDL)	1 (+LN-OJF)	1 <sup>6</sup>	0
Total cases of spalling	11 (+G-REDL)	9 <sup>7</sup> (+LN-OJF)	5	2
Total population of plant gears considered	3,381		2,979	
Interval of operation	2001 – 2016			
Total flight hours in this interval	676,280		599,720	

- 1.6.11.5 According to Airbus Helicopters, only two second stage planet gears have been removed from the epicyclic gearbox as a result of spalling or micro-pits on the outer race during the period between 2009 and the LN-OJF accident in 2016. None of them have been sectioned and subjected to laboratory examination by Airbus Helicopters.

## 1.7 Meteorological information<sup>8</sup>

### 1.7.1 Summary of weather report received from the Norwegian Meteorological Institute

*A low positioned north-east of the route ENBR-ENG C gave northerly 20-25kt winds at ENG C in the morning, and visibility and cloud base were good. Late morning the cloud base was down to 1500ft, with slight rain, and visibility remained good.*

*This low in combination with a second low positioned east of Scotland, gave weak south-easterly 5-10kt at ENBR, and a stratus layer covered ENBR in the morning hours with 500ft as the lowest cloud base reported. The TAF for ENBR was amended due to this rapidly formed stratus layer. During late morning hours the cloud cover broke up, and the wind was veering south-southwesterly 12-17kt with*

<sup>6</sup> This type B planet gear (M338) was installed in an epicyclic module subject to shock load prior to spalling. It was detected by the chip detector; TSN = 1952 FH.

<sup>7</sup> One of the OR spalling events is the M4383 planet gear from an EC 225 LP in Angola. This FAG planet gear was available for examination at Airbus Helicopters early in 2016. It was detected by the chip detector in December 2015; TSN = 657 FH. The total spalling surface was 65 mm<sup>2</sup> and the depth was 0.71 mm.

<sup>8</sup> For decoding of meteorological abbreviations, see: [https://www.ippc.no/ippc/help\\_met.jsp](https://www.ippc.no/ippc/help_met.jsp) and [https://www.ippc.no/ippc/help\\_metabbreviations.jsp](https://www.ippc.no/ippc/help_metabbreviations.jsp)

*highest value reported at the moment of accident. Visibility remained good during all morning hours.*

1.7.2 TAF and METAR for Bergen Airport Flesland (ENBR) and Gullfaks C (ENGC)<sup>9</sup>

1.7.2.1 *TAF ENBR:*

ENBR 290618Z 2906/3006 VRB05KT 9999 BKN010BECMG 2906/2908 18015KT  
FEW030TCU SCT060 TEMPO 2912/2921 SHRA BKN015CB BECMG 2912/2915  
24010KT BECMG 2918/2921 13008KT=

ENBR 290618Z 2906/3006 VRB05KT 9999 BKN010 BECMG 2906/2908 18015KT  
FEW030TCU SCT060 TEMPO 2912/2921 SHRA BKN015CB BECMG 2912/2915  
24010KT BECMG 2918/2921 13008KT=

1.7.2.2 *TAF ENGC:*

ENGC 290500Z 2906/3006 01025KT 9999 FEW025 BECMG 2909/2912 29020KT  
SCT008 BKN014 TEMPO 2909/2918 4000 RADZ BKN008 BECMG 2918/2921  
27010KT FEW012 BKN020 BECMG 2921/2924 18010KT TEMPO 3000/3006 SHRA  
BKN015CB=

ENGC 290800Z 2909/3009 32020KT 9999 FEW010 BKN070 BECMG 2909/2912  
SCT008 BKN014 TEMPO 2909/2918 4000 RADZ BKN008 BECMG 2918/2921  
25010KT FEW012 BKN020 BECMG 2921/2924 16010KT TEMPO 3000/3009 SHRA  
BKN015CB=

1.7.2.3 *METAR ENBR:*

ENBR 290720Z 18012KT 9999 FEW005 BKN008 05/04 Q1004 TEMPO SCT010  
BKN020 RMK WIND 1200FT 20013KT=

ENBR 290750Z 18012KT 9999 SCT008 BKN014 06/04 Q1004 TEMPO SCT010  
BKN020 RMK WIND 1200FT 20014KT=

ENBR 290820Z 19013KT 9999 FEW009 SCT014 SCT018 07/04 Q1004 TEMPO  
BKN014 RMK WIND 1200FT 20014KT=

ENBR 290850Z 20013KT 9999 FEW012CB SCT017 SCT024 07/02 Q1004 TEMPO  
BKN014 RMK WIND 1200FT 21015KT=

ENBR 290920Z 20015KT 9999 FEW012CB SCT018 SCT024 07/03 Q1004 NOSIG  
RMK WIND 1200FT 21015KT=

ENBR 290950Z 20017KT 9999 SCT018 SCT023 07/03 Q1005 NOSIG RMK WIND  
1200FT 19020KT=

---

<sup>9</sup> There were no meteorological observations taken at Gullfaks B (ENQG). For that reason TAF and METAR are listed for the nearby platform ENGC.

ENBR 291020Z 20016KT 9999 SCT020TCU SCT025 07/02 Q1005 NOSIG RMK  
WIND 1200FT 20018KT=

#### 1.7.2.4 METAR ENGC:

ENGC 290720Z 36021KT 9999 FEW010 BKN100 07/03 Q1005 W05/S4=

ENGC 290750Z 02021KT 9999 SCT015 BKN070 07/03 Q1004 W06/S4=

ENGC 290820Z 01023KT 9999 -RA BKN015 06/02 Q1004 W05/S4=

ENGC 290850Z 35021KT 9999 -RA BKN015 06/02 Q1004 W06/S4=

ENGC 290920Z 34020KT 9999 -RA BKN015 06/03 Q1004 W05/S4=

ENGC 290950Z 34022KT 9999 -RA SCT012 BKN020 05/02 Q1003 W05/S4=

## 1.8 Aids to navigation

1.8.1 HKS241 was cleared to fly ILS Y RWY 17 towards Bergen airport Flesland.

1.8.2 In accordance with the requirements, the following aids to navigation were available onboard the aircraft:

- GNSS, VOR, ILS, DME

1.8.3 The following navigational aids were available at the airport:

- Flesland DVOR/DME (frequency 115.550 MHz and with ident FLS).
- LOC/GS (frequency 109.900 MHz paired with DME and both with ident BR)

1.8.4 LN-OJF was on its planned track when the accident happened.

## 1.9 Communications

1.9.1 Playback of the radio communication shows routine and normal communication between LN-OJF and air traffic services, until the helicopter disappeared from the frequency.

1.9.2 LN-OJF, with call sign HKS241 (Helibus241), checked in with Flesland Approach (APP), frequency 121.00 MHz, at 11:46:40. The co-pilot was handling the radio at this time. Among other things, he stated that they were flying at 3,000 ft. They received clearance from the radar air traffic controller to fly directly to VENIN, a Terminal Manoeuvring Area (TMA) waypoint east of Turøy, approx. 10 NM from Flesland. The co-pilot confirmed the clearance and requested, out of routine, using approach procedure ILS Y 17. At 11:51:18, HKS241 received clearance for a new altitude, 2,000 ft, as well as for using approach procedure ILS Y 17. One minute later, at 11:52:29, the radar air traffic controller issued a new QNH, 1005 hPa. The captain confirmed receipt of new QNH at 11:52:31. This was the last radio communication with HKS241.

1.9.3 The AIBN's interview with the radar air traffic controller at Flesland Approach confirmed that radio communication between LN-OJF and the air traffic service was normal until the last transmission to Flesland Approach, frequency 121.00 MHz at 11:52:31. After

this, however, there were disturbances on the frequency described by the radar air traffic controller and supervisor at Flesland Approach as loud, sharp and static noises from the speaker. These radio disturbances subsided. Playback of the radio communication has identified four brief periods with a dull, metallic noise during the period between 11:53:50 and 11:54:22.

- 1.9.4 About 30 seconds later, they heard another noise, which they experienced as blocking the frequency. It was described as if someone was holding in the transmit button, but without anyone talking. Playback of the radio communication confirms that, for a period of 14 seconds from 11:54:46, noise can be heard on the frequency. The Cockpit Voice Recorder (CVR) in the helicopter was no longer recording at this time (see chapter 1.11.1.4). One can therefore not state with certainty that the noise came from LN-OJF.
- 1.9.5 The radar air traffic controller then called HKS241 multiple times, without response. The helicopter was no longer visible on the radar screen. At 11:56:40, Midnight1, a surveillance aircraft from the Norwegian Coastal Administration that was in the area, was asked to search for HKS241 near the VENIN area. At 11:57:50, Midnight1 confirmed smoke from the area.

## **1.10 Aerodrome information**

Not applicable to this investigation.

## **1.11 Flight recorders**

### **1.11.1 Combined Voice and Flight Data Recorder (CVFDR)**

#### **1.11.1.1 *General***

LN-OJF was equipped with a Honeywell 6021 Combined Voice and Flight Data Recorder (CVFDR), part number 980-6021-066, serial number AR-COMBI-12025 (see Figure 14). The model was developed for installation in general aviation fixed wing aircraft and helicopters to accommodate mandatory cockpit voice and flight data recording requirements. The audio and flight data are stored on solid state memory that is protected within a Crash Survivable Memory Unit (CSMU).

The AR-COMBI records up to four audio channels. Three of the channels are allocated to flight crew communications (commander, co-pilot and PA system/third crew position) and one channel is allocated to the Cockpit Area Microphone (CAM). The CVFDR system installed in the EC 225 LP records three audio channels:

- The commander position
- Co-pilot position
- CAM

The AR-COMBI installed in LN-OJF recorded the last:

- 120 minutes of audio.
- 27 hours of flight data at a rate of 256 words per second.



The CVFDR was removed from the tail boom that had been picked up from the seabed in the late evening of the 29 April and transported in fresh water by the AIBN to the Air Accidents Investigation Branch (AAIB) at Farnborough UK. Initially, it was not possible to download data because the wiring between the base unit and the CSMU was damaged. Following repair a successful download of all the data was performed.



Figure 14: CVFDR from LN-OJF as received at the AAIB. Photo: AIBN



Figure 15: M^ARMS PCMCIA card. Photo: AIBN

### 1.11.1.2 Cockpit Voice Recorder (CVR) information

The CVR had audio files from before engine start up in Bergen, the flight to Gullfaks and the return flight. The files were examined by the AIBN together with two pilots from CHC Helikopter Service. The examination confirms standard operation up until a warning chime at the last second before end of recording.

Following the readout at the AAIB, four audio files was transferred to the BEA in France for further analysis. Spectrum analysis from the CAM recording is shown in Figure 16. The CAM spectrogram shows that the CVR recording ended 1 second after the first transient event.

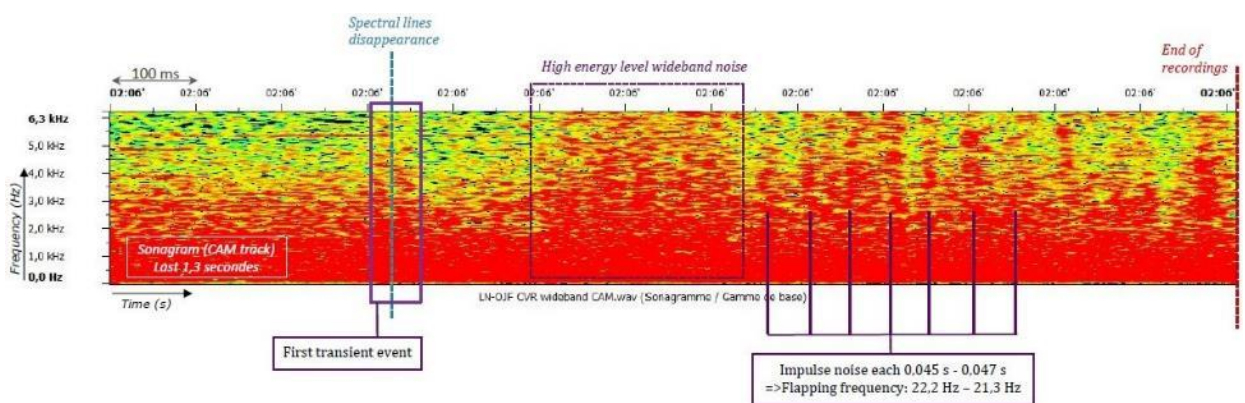

Figure 16: Spectrum analysis from the CAM audio file showing 1.3 seconds believed to be the beginning of the MGB break-up. Source: BEA

### 1.11.1.3 Flight Data Recorder (FDR) information

The FDR recording ended at the same time as the CVR recording. The examination of the FDR plot confirms normal operations until the engine torque started to drop. This time is

defined as T0 in this investigation. Because the CVFDR recordings disappeared at about T0+1 second, the focus has been on analyzing information stored at the HUMS PCMCIA card (see chapter 1.11.2.4).

#### 1.11.1.4 *Loss of CVFDR data*

Both the voice and data recordings stopped at the same time, suggesting that power to the CVFDR was cut. The Miscellaneous Flight Data Acquisition Unit (MFDAU), which supplied the CVFDR with data, continued to operate after the CVFDR stopped and data were transferred to the PCMCIA HUMS memory card.

The CVFDR is powered from the battery bus and will start recording as soon as the bus is energized. The CVFDR power supply can be interrupted by loss of the battery bus or by means of two switches which are designed to operate in the event of an accident. One immersion switch operates on contact with water, and one switch operates if being subject to high g-forces. The g-switch is installed to satisfy an airworthiness requirement necessitating that the cockpit voice recording stops within 10 minutes after a crash. It operates by mechanically sensing the level of acceleration in all three axes, cutting electrical supply once 6 G has been exceeded.

The AAIB investigation into the G-REDL accident also revealed that the flight recorders stopped recording prior to the end of the accident sequence and this was most likely caused by the g-switch. For this reason, safety recommendation SR 2011-045 and SR 2011-046 were issued to EASA and the FAA in order to “*require the ‘crash sensor’ in helicopters, fitted to stop a Cockpit Voice Recorder in the event of an accident, to comply with EUROCAE ED62A / RTCA DO204A*”. These recommendations have not been closed (see chapter 1.18.4.6).

### 1.11.2 Vibration Health Monitoring (VHM)

#### 1.11.2.1 *Regulatory requirements*

Vibration Health Monitoring (VHM) systems was not mandatory for establishing instructions for continued airworthiness at certification.

After the accident to the AS 332 L1, LN-OPG (the Norne accident<sup>10</sup>) in 1997 it was argued for making VHM systems mandatory for helicopter transport offshore. VHM was established as a customer requirement to the helicopter operators given in the Norwegian Oil & Gas guideline 066, 1 December 2000.

Following EASA's establishment in 2003, the National Aviation Authorities continued to apply national VHM requirements for ‘demanding’ operations, such as operations in the North Sea.

On 1 July 2005 VHM was made mandatory by the CAA Norway for helicopters used in connection with petroleum activities on the Norwegian continental shelf and having a maximum approved seating configuration of more than nine<sup>11</sup>.

---

<sup>10</sup> See AAIB/N Rep.: 47/2001: <https://www.aibn.no/Luftfart/Rapporter/2001-47-eng>

<sup>11</sup> Regulation 1 February 2005 no. 216 concerning the vibration health monitoring systems for helicopters (BSL D 1-16).

For the EC 225 LP these requirements are met by the use of Health and Usage Monitoring System (HUMS).

#### 1.11.2.2 *HUMS configuration on EC 225 LP*

Health and Usage Monitoring System (HUMS) is designed for monitoring the status of the dynamic components (drivetrain) in the helicopter and the vibration generated by the rotors. HUMS is intended to detect wear, degradation and anomalies in the drivetrain systems. The process of analyzing data and taking action on generated alerts is integrated in the Aircraft Maintenance Program (AMP).

On the EC 225 LP the HUMS forms part of the M`ARMS<sup>TM</sup> and uses accelerometers to capture the vibration of rotating components.

The system processes the raw signal from the accelerometers to produce the condition indicators, which are then used to monitor the vibration levels of individual components. The acquisition cycle for one complete set of samples typically lasts about 20 minutes, although some accelerometers are sampled more frequently.

At the end of each flight, as the helicopter is shutdown, the system downloads the HUMS data onto a PCMCIA card. The PCMCIA card can store HUMS data for a maximum of five complete acquisitions.

The number of acquisitions will be correspondingly less on flights where insufficient time is available to capture five complete acquisitions, or where insufficient time is spent in certain flight phases particular to certain condition indicators, or if an acquisition is rejected.

The PCMCIA card usually contains two types of files. The .255 file format contains HUMS related raw data to be analyzed on the system's Ground Station Computer (GSC). The .raw file format contains flight data acquired from the MFDAU. Data stored at the PCMCIA is also used for Flight Data Monitoring and contains an extract of FDR data.

The HUMS data is transferred from the PCMCIA card to the Ground Station Computer (GSC). On the GSC the condition indicators are calculated and reviewed by engineering personnel to identify, for example, any indicators that may have exceeded their thresholds.

Thresholds are critical values for condition indicators which are set to alert the user of significant changes in their values. Two types of alerts exist:

- Amber alerts give an advance warning of a potential problem. This prompts the close monitoring of the indicator and maintenance inspections.
- Red alerts indicate that a more serious problem has potentially been found and maintenance action is required before the helicopter is released for flight.

Alerts are normally generated when two out of five consecutive indicator values exceed their respective threshold. Two types of thresholds exist:

- Learned thresholds are a function of the mean and standard deviation of the indicator values recorded to date. They are particular to an individual part on an individual



helicopter and based typically on the first 25 flight hours following a part installation or maintenance action on the zone.

- Fixed or maximum thresholds are defined by the helicopter manufacturer’s design office.

1.11.2.3 HUMS detection capability

Figure 17 gives an overview of some components monitored by the HUMS on EC 225 LP. A total of 25 accelerometers were installed on LN-OJF; eight accelerometers are fitted to the MGB. The first and second stages of the epicyclic module are monitored by one accelerometer, sensor 6 (11RK6). The rotor mast and main rotor bearings are monitored by one accelerometer, sensor 7 (11RK9).

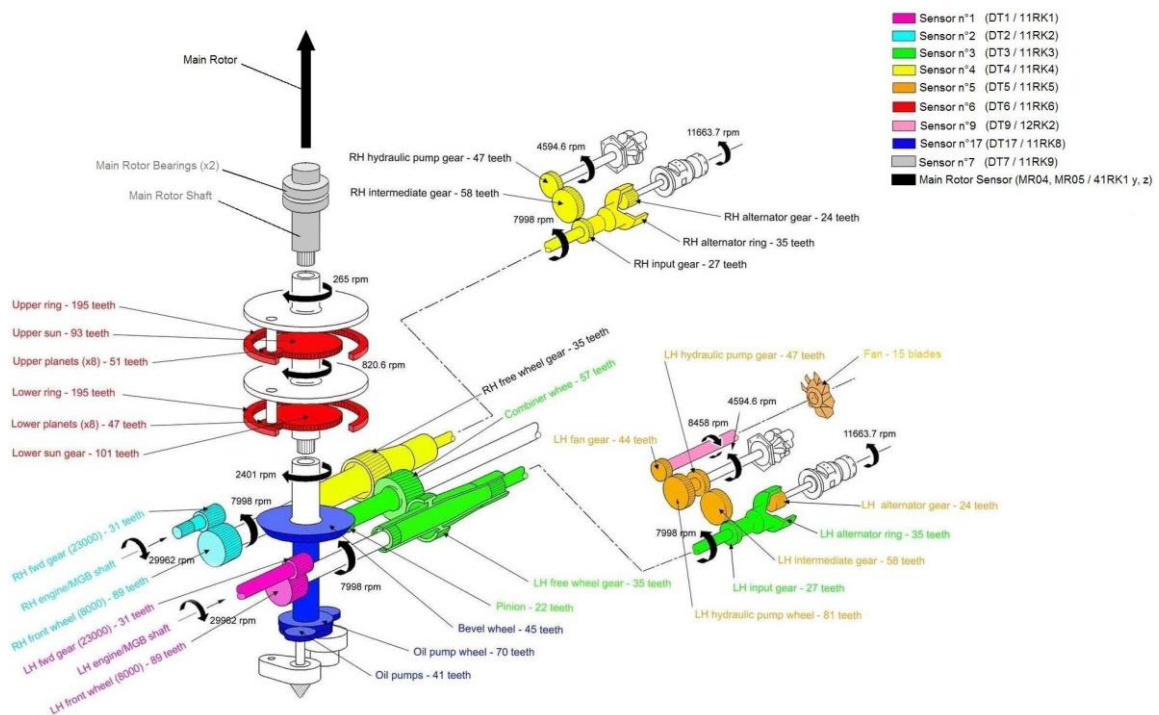

Figure 17: Drive train of the EC 225 LP MARMS™ (MGB). Source: Airbus Helicopters

The installation of HUMS has been recognized as providing a significant safety improvement to helicopter operations. However, the system has its limitations which is described in the G-REDL report. The effectiveness of the vibration analysis for each component depends on the distance of the accelerometer from the component, the transmission path of the vibration and the quality of the electronic signal acquired by HUMS. If any one of these conditions are affected, then the HUMS ability to detect component degradation diminishes. Epicyclic module planet gear bearing monitoring is particularly challenging, with multiple components rotating on a moving axis. This is also because the energy produced by the meshing of gears tends to be higher than that produced by bearings.

Vibration produced by bearings is of high frequency and low amplitude, which attenuates with distance, meaning that the accelerometer must be located in close proximity to the bearing for effective monitoring. For components such as the tail rotor drive shaft support bearings, the accelerometers are mounted close to the bearings and monitoring has proven to be effective. As epicyclic bearing information is not synchronous with shaft rotation,

signal averaging is not used in bearing vibration signal acquisition. This means that components generating signal noise, in the same frequency range as the bearing acquisition, will contribute to the levels of noise in the bearing signal.

#### 1.11.2.4 Download from the PCMCIA memory card for LN-OJF

The HUMS PCMCIA memory card from LN-OJF was secured at the accident site, and sent to the BEA for download.

The PCMCIA card from LN-OJF contained 12.65 seconds more data than the CVFDR (see chapter 1.11.1.3).

Times recorded the PCMCIA has been identified to be about 11 minutes ahead of UTC time.

The first observable anomaly in the PCMCIA .raw file is that the torque value goes towards 0 within 0.5 seconds. For ease of reference, the point where the torque value starts to deviate from normal cruise value is defined as T0 in Table 7.

Table 7: Data from the PCMCIA .raw file

Time (second)	Event
T0	Torque value deviates from cruise value
T0	Eng 1 and 2 NF starts to increase
T0+0,25	MGB starts to loose oil pressure (0 at T0+2s)
T0+0,25	MGB oil press warning (duration 1.5 s)
T0+0,25	Discrete word «Aircond» change state
T0+1	NR starts to drop. (0 at T0+3s)
T0+1	Signal variations begin on lat/long/vertical accelerometers
T0+1	NF speeds top out at 115%
T0+1,5	Discrete word «FDRS fail» change state
T0+1,5	Discrete word «Door or CWL» change state
T0+1,5	Helicopter starts to roll
T0+2	First movement collective pitch lever
T0+2,25	MGB oil sump chip warning
T0+4	NR at 0%
T0+4	Helicopters starts to pitch down

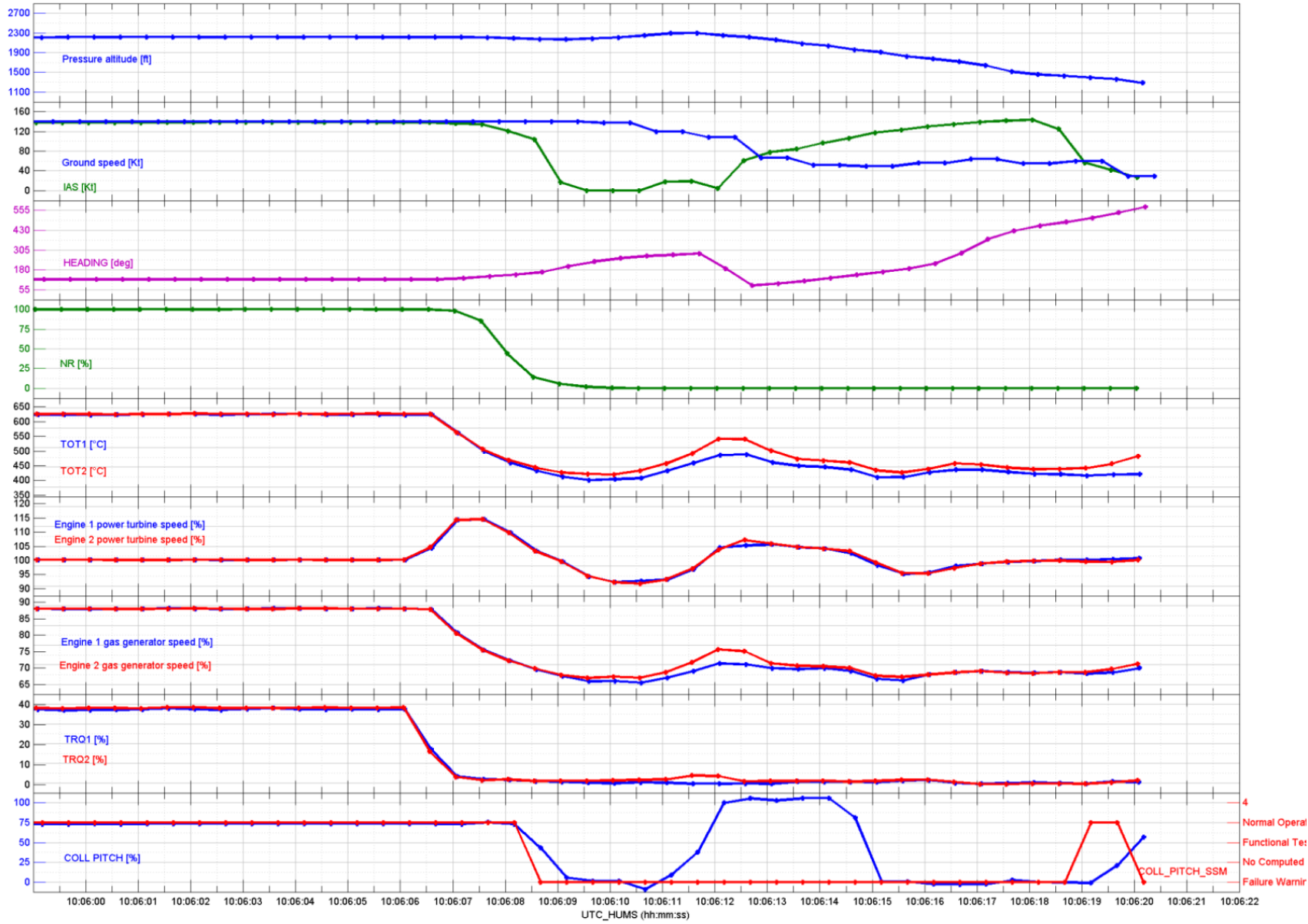

Figure 18: Recorded parameters from the PCMCIA card. T0 is defined as 10:06:06. Note: Time is UTC minus approximately 11 min. Source: BEA

#### 1.11.2.5 HUMS data for LN-OJF prior to 29 April 2016

Airbus Helicopters performed a specific analysis of vibration signatures, i.e. MARMS™ condition indicators, following the accident. The analysis was conducted out of a backup database provided by the operator, CHC Helikopter Service, with data history between 4 March to 29 April 2016, and which represents more than 150 flying hours of vibration data. As the session associated to the “accident event” could not be finalized, the last flight is missing.

The following conclusion is cited from the Airbus Helicopters report on the HUMS data analysis:

*Based on the detailed review of all MARMS™ Condition Indicators computed on A/C LN-OJF S/N 2721, Airbus Helicopters confirms that neither clear trend nor abnormal vibration behaviours have been observed on any dynamic parts monitored by this MARMS™ system.*

*Therefore, prior to the last flight and accident event, Airbus Helicopters confirms that the MARMS™ system does not show evidence of any vibrations that could predict any incipient failure. In addition, prior to this accident, Airbus Helicopters had no Expert Diagnostic Report (EDR) being currently in progress on this aircraft. Moreover, no exchanges or on-going HUMS issues were in treatment between CHC Norway HUMS Team & HUMS Technical Support from AH for the LN-OJF.*

The helicopter manufacturer has confirmed that the primary method of detecting planet gear bearing degradation was by relying on the gears shedding metallic debris before failure, which in turn would be discovered by the chip detection system (see chapter 1.6.9).

#### 1.11.2.6 Development of VHM after the G-REDL accident

The AAIB report concerning the G-REDL accident (see chapter 1.18.3) discussed the VHM/HUMS systems limitations for detecting degradation of planet gear bearings. For this reason, safety recommendation SR 2011-041 was issued to EASA in order to “research methods for improving the detection of component degradation in helicopter epicyclic planet gear bearings” (see chapter 1.18.4.5).

As a result of this recommendation, EASA launched a research project 'Vibration Health Monitoring and Alternative Technologies' (Tender number EASA.2012.OP.13). The study was performed by Cranfield University in the UK and the report was finalized in June 2015.

A wireless transmission system and a broadband sensor were fitted to the planet gear of an operational gearbox and tested at operational speeds, temperatures and loads. Damage was introduced into the planet gear bearing outer races. The report from Cranfield University concludes that:

*The research programme has shown that internal sensors for helicopter main rotor gearboxes are feasible and that they are able to offer improved detection when compared with traditional external vibration measurements.*

However the report also notes that:

*Further development is needed to transition this concept from being feasible to a deliverable product, which can be incorporated into operational gearboxes to provide a safety benefit.*

According to Airbus Helicopters, they have performed a worldwide survey on the detection technologies (mainly vibration but not limited to) of cracks inside an epicyclic train for relevant industries. Their conclusion is that no solution presently exists on the market for such degradation detection. Currently, Airbus Helicopters is researching possibilities of using accelerometers internally on each crankpin, but the results have so far not been conclusive.

## **1.12 The accident site and wreckage information**

### **1.12.1 The accident site**

#### **1.12.1.1 *Description of accident site***

The helicopter fell on sloping rock southeast of Storeskitholmen near Turøy in Øygarden municipality. The actual island is about 210 metres long and 97 metres wide. The area is approximately 16,160 m<sup>2</sup> and the highest point on the island is 15.7 metres. The island consists of rock, partially covered by heather.

The majority of the helicopter slid off the island and into the sea, where it came to rest a few metres from shore at a depth of about 5 metres.

The main rotor detached from the helicopter just above the western end of the Turøy Bridge. It continued to fly on its own while rotating toward the north and landed on Storskora island, about 450 metres from the separation point, approximately 550 metres due north of the crash site on Storeskitholmen.

A number of parts from the helicopter were found dispersed over an area of about 180,000 m<sup>2</sup> (see Figure 21).

Seabed conditions in the relevant area varied considerably. Near islands, the seabed was steep in certain places, characterised by rock and stones. Between these areas, there were portions where the seabed was relatively flat and sandy. In order to achieve a good overview of depth conditions, the area was mapped using a multibeam sonar. It then became clear that a relatively deep flat-bottomed channel ran directly north/south under the Turøy Bridge. The greatest depth, approaching about 40 metres, is south of square 26 (see Figure 20).

Most areas down to a depth of 15-20 metres were covered by dense kelp forest, more than a metre high in some locations.

#### **1.12.1.2 *Search for aircraft parts***

An effort to locate and salvage parts from the helicopter started shortly after the accident. The combined voice and flight data recorder was recovered from the sea within 24 hrs of the accident.

On 30 April, the main wreckage was lifted from the sea and the main rotor was lifted down from Storskora. A number of key parts from the main gearbox were also found at this time, e.g. part of a second stage planetary gear that was later found to have a fatigue crack.

It soon became clear that a number of important parts of the main gearbox and its attachment were missing. An extensive search of both land and sea was undertaken.

A search party from the Norwegian Civil Defence searched a defined area onshore using metal detectors. The area is indicated on the map Figure 19 below.

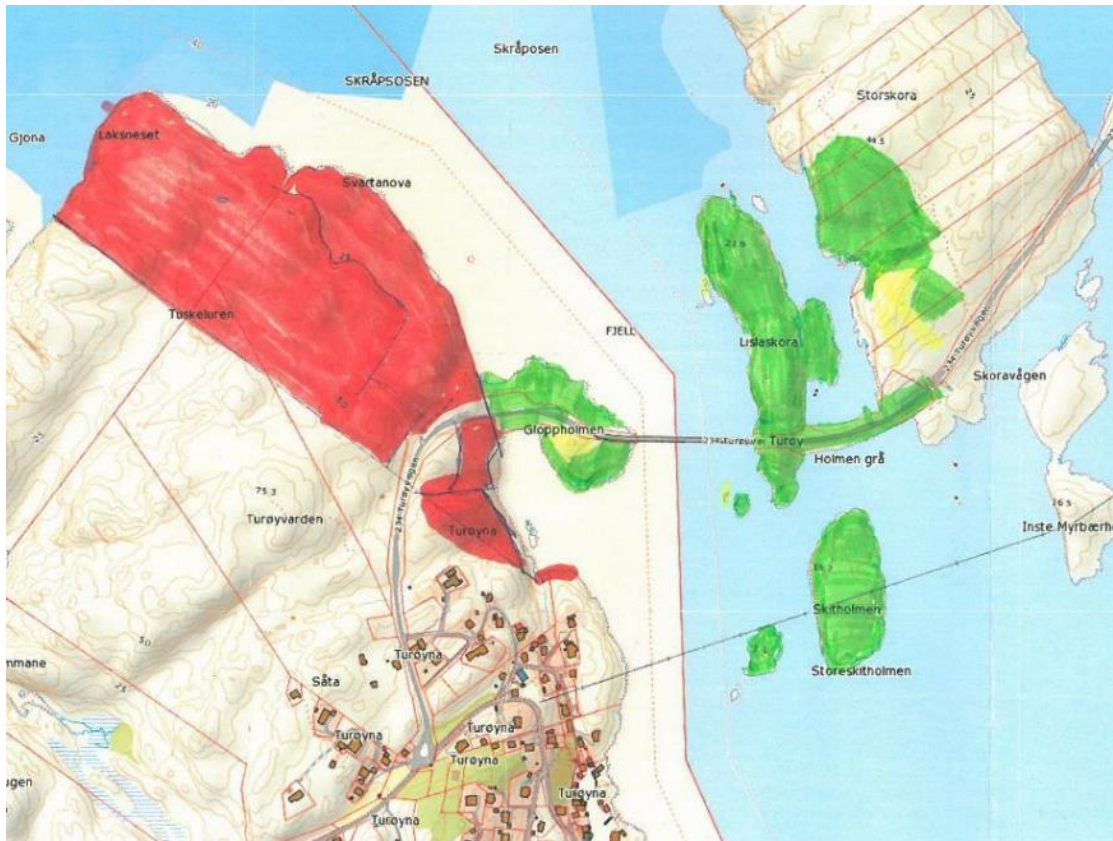

Figure 19: A preliminary sketch of the initial land search area (green) and an additional area (red).  
Source: The Norwegian Mapping Authority and AIBN



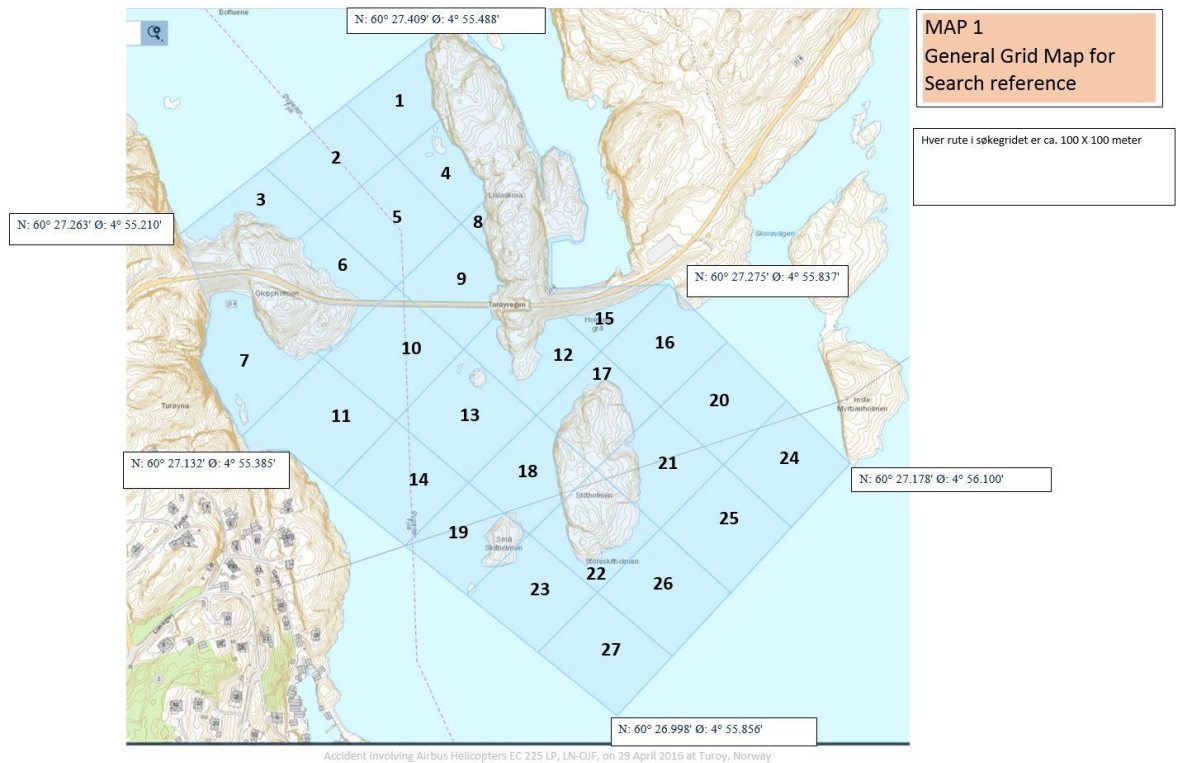

Figure 20: The sea search area divided into 27 squares, each measuring approximately 100 x 100 metres. Source: Norwegian Coastal Administration and AIBN

Based on the helicopter's altitude, speed, wind, and assumed position where the main rotor separated, a relevant search area for searches in the sea was estimated to be within an area of around 400 x 700 metres (280,000 m<sup>2</sup>). To make the coordination and plotting easier, a grid was prepared for this area containing 27 squares, each measuring approx. 100 x 100 m (see Figure 20).

During the search the following methods were applied:

- Search involving divers. Divers from the Bergen Fire Department and navy divers from the Norwegian Armed Forces examined large sections of the seabed. To facilitate systematic searches, the navy divers laid out lines on the seabed. During the period 1 May - 11 September, a total of 354 dives were undertaken in the area.
- Search with a Remotely Operated Vehicle (ROV). All areas not covered by kelp forest.
- Search for steel parts with a magnet sledge. A one-metre wide sledge with 14 powerful magnets attached to flexible arms was pulled along the seabed by a vessel. The sledge also had two video cameras, one pointed down towards the magnets and one camera filmed in front of the sledge. This is described in more detail in chapter 1.19.

The organized search for parts was called off in September 2016. At this stage four second stage planet gear wheels together with two sections of the fractured gear wheel were salvaged. Additionally a number of parts and fragments from the gear bearings (including inner races and rollers) were salvaged.

Additional parts that would be of interest were the remaining gears, the second stage planet gear carrier and the forward suspension bar. To continue searching for parts would have required significant resources. The costs were assessed against the likelihood of discovering more parts significant for the investigation. The parts would have been in the seawater for several months and hence it was considered less likely that any fracture surfaces would provide any useful information, due to corrosion.

Later, the Norwegian Naval Diving School used the area for exercises. This was on their own initiative and agreed with the AIBN. During one such diving exercise in February 2017 the second stage planet carrier was found (see chapter 1.16.4). The inner race still attached to the carrier was in surprisingly good shape.

## 1.12.2 Wreckage information

### 1.12.2.1 Location of recovered parts

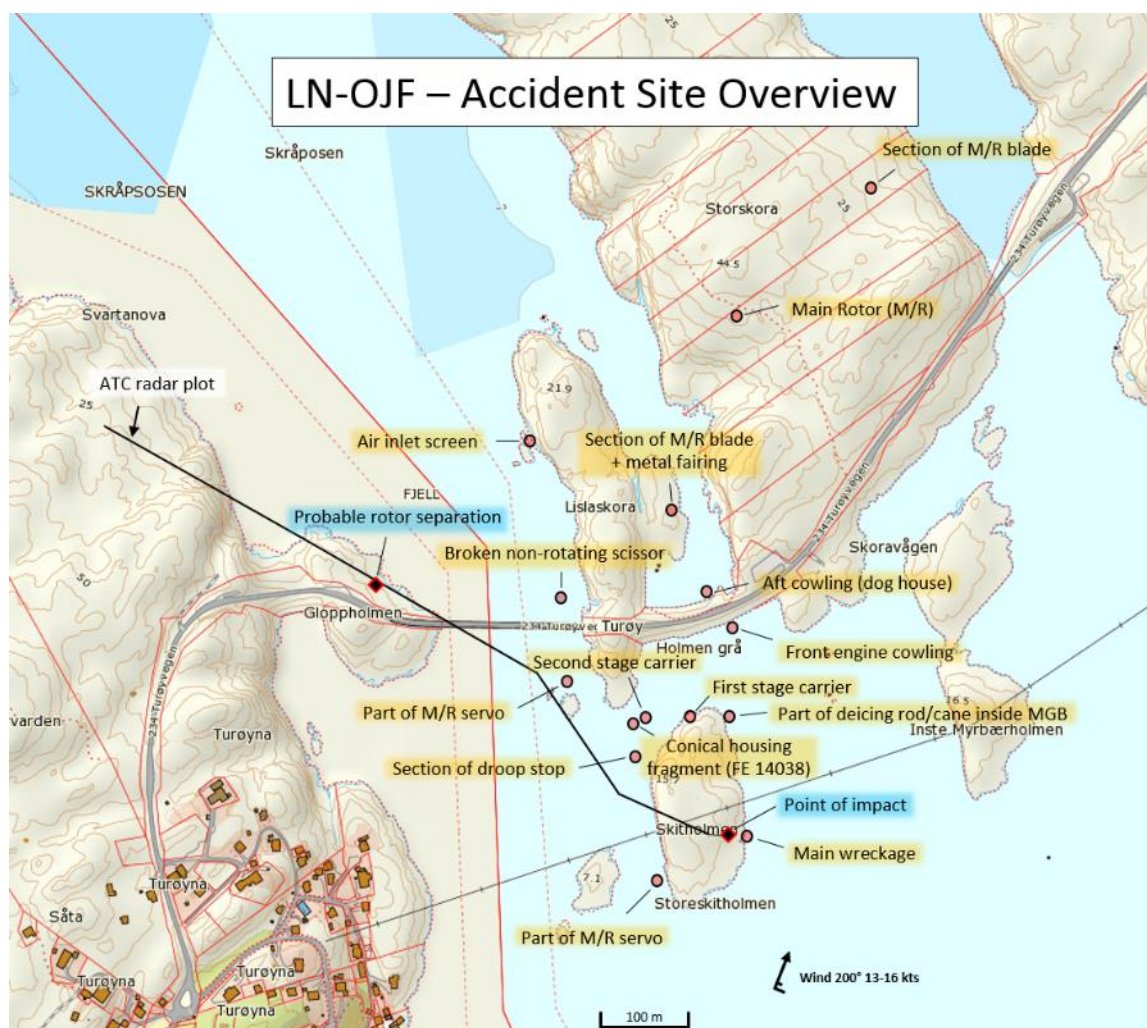

Figure 21: This map does not include all findings. However, it illustrates the location of larger parts or parts where the location can give useful information. The AIBN finds reasons to believe that the aft MGB cowling did fall down on the shown position, but was rather moved there by people at an early stage. Source: The Norwegian Mapping Authority and AIBN



As mentioned in chapter 1.12.1.1, a number of parts from the helicopter were found dispersed over an area of about 180,000 m<sup>2</sup>. However, most of the helicopter wreckage came to rest on the seabed just outside Storeskitholmen. The largest part found separate from the accident site itself, was the main rotor, which was at Storskora Island. The map in Figure 21 shows where a number of parts were discovered.

#### 1.12.2.2 *Initial handling of wreckage parts*

All retrieved parts were initially laid out for inspection in a storehouse at the Haakonsvern Navy Base outside Bergen. Representatives from the BEA, the AAIB, the CAA-N, Airbus Helicopters and CHC Helikopter Service in addition to the AIBN were present during this inspection. On 5 May 2016, all the retrieved parts from the helicopter wreckage were transported from Haakonsvern to the AIBN premises in Lillestrøm. At the AIBN all parts of particular interest for the investigation were selected for more detailed inspections/examinations. The examinations are described in the chapters below and in chapter 1.16.

#### 1.12.2.3 *The helicopter cockpit and cabin*

The main parts of the helicopter cabin, including the cockpit, were recovered as one piece, held together by bars, wires, tubes and pipes, but otherwise structurally damaged. They were damaged to such extent that it was almost impossible to conduct any meaningful investigations of the wreckage components (see Figure 22).

#### 1.12.2.4 *Flight controls*

The flight controls were extensively damaged during impact with the small island and it was impossible to perform a complete evaluation of the system. There was no evidence of a pre-existing failure or restriction within the flight control system. All damage observed was consistent with the helicopter's impact with the island.

#### 1.12.2.5 *Tail and tail rotor*

The tail boom including the tail fin, tail rotor drive train, flight controls and the CVFDR were located on the sea bed near the main wreckage. The tail rotor including the tail rotor gearbox was found on the sea bed separated from the tail boom. All tail rotor blades were extensively and evenly damaged, indicating that the tail rotor had rotated at high speed during impact. The tail rotor drive shaft had several circumferential scratches and scores indicating that it had rotated at high speed during impact. The tail rotor drive shaft tunnel was at one position dented at the top. This coincided with a slight strike from a main rotor blade.

The horizontal stabilizer was found on the sea bed separated from the tail boom and tail rotor.



Figure 22: The main wreckage during recovery. The tail boom seen at the lower right had already been recovered. Photo: AIBN

#### 1.12.2.6 Engines

Both engines were attached to the main wreckage when they were recovered from the sea (see Figure 22). The engines were first examined at Haakonsvern Navy Base by the Safran technical advisor, under the supervision of the AIBN and the BEA.

The first visual inspection of the main wreckage revealed that both engines were still mounted to their airframe attachments and separated by the longitudinal fire wall. The left engine was attached by one of its two forward mounts, while the right engine was attached by both forward mounts. Both engines had detached from the main gearbox (rear attachment). The engines were then separated from the main wreckage for further on site examination. The examination was accounted for in Safran "On Site Examination Report

– April 30 to May 3, 2016 – Bergen – Norway”, dated May 10, 2016, Report Reference RA2016 098, which concluded:

*The visual examinations of the engines revealed significant and identical damages on each engine. The main damages are, a significant bending, the separation and rupture of both Modules MO1 and the rupture of the power turbine assembly. The damages observed are of 2 different types: Deep impacts and perforations in the lower part of the engines caused by the kinetic energy at the time of the impact to the ground and important deformations (bending) linked to overload applied on the engines. The visual examination revealed deep Foreign Object Damages and important rubbing marks on the Power Turbines. These findings are typical power signature at the time of the impact to the ground.*

Figure 23 shows the engines in the AIBN hangar. The engines were later shipped in sealed transportation boxes to Safran in Tarnos, France for detailed investigation. Opening of the boxes and investigation of the engines were supervised by the BEA, on behalf of the AIBN. The investigation was documented in Safran Investigation Report TEA2016-098 2, dated June 29, 2016, which concluded:

*The disassembly of the Makila 2A1 engines SN 13228 and 1127 was carried out at Safran Helicopter Engines in Tarnos, France in the presence of BEA representative. The engines tear-down and examination revealed damages consistent with those observed during the wreckage examination and recorded in the report reference [RA2016 098]. On both engines there was a symmetry concerning all damages found and all these damages were the consequence of collision with the ground and external loads applied on both engines.*

*The Engines parameters (Downloaded from the PCMCIA card) analysis confirmed a normal behaviour of the engines until the end of the recording.*



Figure 23: The engines at the AIBN hangar. They had similar damages to a large extent. Both intake sections (Module M01) which had separated from the front part of the engines can be seen to the right of the photo. Photo: AIBN

HUMS data indicates that the Power Turbine rotation speed (N2) on both engines increased significantly when the torque disappeared, but did not exceed the overspeed



threshold set at 117 %. Gas Generator rotation speed (N1) was approximately 70 % and N2 around 100 % for each engine at the end of the recording.

#### 1.12.2.7 *Main rotor*

The main rotor including the main rotor mast, parts of the conical housing including the lift bearing and two suspension bars were discovered on Storskora Island (see Figure 24).

The main rotor blades were dismantled from the rotor head and examined by the AIBN. In general, the innermost sections of the main rotor blades were structurally intact, but the outer parts of the black, white, red and blue blades were significantly damaged. Several blades had lost large sections of the honeycomb structure behind the main spar. There was a clear imprint on the yellow blade, after contact with one of the engine's air inlet screens, 1.9 metres from the blade bolts.

The rotor head and the mast were sent to Airbus Helicopters and further examined under the supervision of the AIBN and the BEA. Detailed examination of the Main Rotor Mast coupling splines and the Main Rotor Mast bearing from the LN-OJF, has not revealed any anomaly and was in a normal and standard operational condition.



Figure 24: The main rotor and rear suspension bars as found at the island Storskora.  
Photo: AIBN

#### 1.12.2.8 *Main rotor gearbox attachment*

Early on, it was considered that the accident might have been caused by a fault in the attachment of the main gearbox, a fault in the conical housing or a fault in the epicyclic gear module. Consequently, great attention was paid to the attachment of the MGB. The

wreckage was closely examined for parts of the attachment. All available parts were later sent to Airbus Helicopters for a detailed investigation (see chapter 1.16 for additional information about the metallurgical examination).

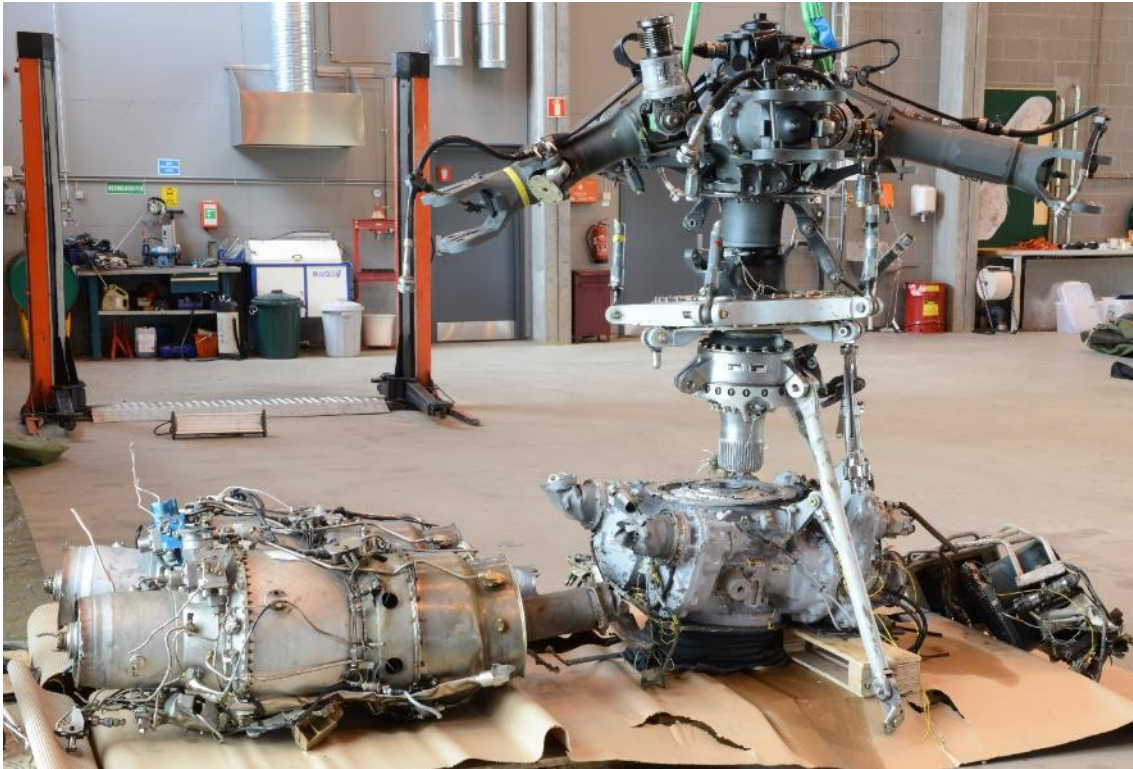

Figure 25: Engines, substantial parts of the MGB, two suspension bars and main rotor head assembled at the AIBN premises. Photo: AIBN

#### Front suspension bar

The front suspension bar, including the fuselage fitting were missing (see Figure 2 for general layout). The fuselage fitting was pulled away from the transmission deck support plate in such a way that all four bolts were damaged to various degrees (static failure). The upper clevis pin, two safety pins and a section of the attachment lug were still in place in the conical housing.

#### Left suspension bar

The left suspension bar including the strut fitting was found attached to the conical housing. Both clevis pins were found in-place secured with two safety pins in each.

#### Right suspension bar

The right suspension bar was found attached to the conical housing. The upper clevis pin was found in-place secured with two safety pins. The strut fitting, a clevis pin and parts from two individual safety pins were found close to the main rotor.

#### The flexible mounting plate

The flexible mounting plate was found attached to the main gearbox. The front part of the plate was bent upwards 45° and was attached to a part of the structure torn off from the cabin ceiling. The flexible mounting plate had separated from the cabin structure at the



rear attachment. Eight of the 17 fastening bolts had disappeared. The remaining nine bolts had failed in shear.

### Bolts

Several damaged main gearbox attachment bolts were found during a thorough examination of the wreckage.

#### 1.12.2.9 *Main rotor gearbox (MGB)*

All parts from the main module and accessory modules were sent to Airbus Helicopters for detailed examination under supervision of the French and Norwegian accident investigation boards. For other investigations of MGB parts, see chapter 1.16.

The main module was relatively complete and with little damage. Both ingoing high speed shafts from the engines had been twisted off near the main gearbox in a manner which indicates high torque, possibly combined with bending. The linking tubes (liaison tubes) were heavily bent upwards (see Figure 25). The oil sump in the main module contained large quantities of metal bits and shavings. All results from the examinations of the main module indicate that the helicopter hit the ground with great force and then ended up in the sea. Seawater had caused heavy corrosion, particularly to magnesium parts. Furthermore, the findings are consistent with fracture in the epicyclic reduction gear module and indicate that the main module continued to rotate after this.

The right and left accessory modules were relatively complete and with only minor damage (see Figure 26). Both generators had come loose from the gear box. Both hydraulic pumps were still attached. The axles for the cooling fan and tail rotor had broken off very close to the connections. Moreover, seawater had caused heavy corrosion, particularly to magnesium parts.

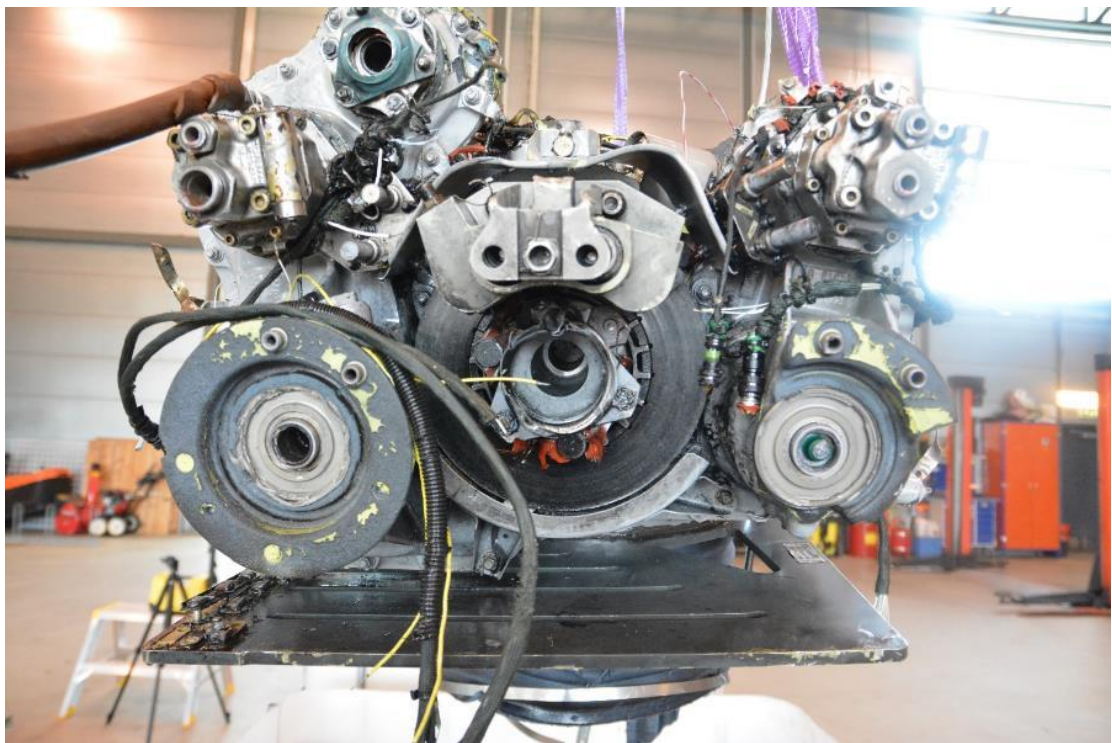

Figure 26: L/H and R/H accessory modules seen from behind. The flexible mounting plate is seen attached to the MGB oil sump. Photo: AIBN

### 1.12.3 Check for traces of explosives

The National Criminal Investigation Service (KRIPOS) took samples from the main gear box and the surrounding area to check for remnants of explosives. The samples did not show any traces of explosives.

## 1.13 **Medical and pathological information**

All occupants suffered immediate fatal injuries. Autopsy examinations of all the occupants were performed at the Department of Forensic Medicine, the University in Bergen. These examinations confirmed multiple injuries consistent with high impact related forces. According to the medical examiner, all persons on board are assumed to have been alive when the helicopter hit the ground.

## 1.14 **Fire**

1.14.1 The helicopter crashed into sloping rock on Storeskitholmen. Fuel from the helicopter's fuel tanks was dispersed over a large area and ignited immediately. The fire continued to feed on the fuel for a while as well as on other flammable material left onshore. Most of the helicopter continued into the sea and was not affected by the fire.

1.14.2 The fire kept burning on the small island, and gradually turned into a heather fire. Fire-fighting personnel arrived at the scene and extinguished the fire using fire-extinguishing whips.

## 1.15 **Survival aspects**

### 1.15.1 General

The accident was not survivable regardless of protective equipment or search and rescue activities.

### 1.15.2 Search and rescue

1.15.2.1 It was immediately obvious that a serious accident had taken place involving a helicopter at Turøy. A number of eye witnesses called the police and notified them of the accident. When the air traffic services became aware that the HKS241 radar symbol had been lost, and that the crew did not respond to radio calls, they feared that the helicopter had an accident. This was confirmed as early as at 11:57:50 when the Midnight1 surveillance aircraft reported smoke from the area. The air traffic service notified the Joint Rescue Coordination Centre for Southern Norway (HRS-S) of the accident at 1159 hrs. At 1204 hrs, the Joint Rescue Coordination Centre raised a full emergency alarm.

1.15.2.2 The first boat, a rigid inflatable boat (RIB), arrived at the crash site as early as 1201 hours, six minutes after the helicopter crashed. Two other light boats arrived a minute later. However, the people in the boats immediately realized that life-saving actions were not possible, nor necessary.

1.15.2.3 The Sotra fire department was initially notified of a work accident at 1159 hrs. They first responded with three vehicles and six people at 1202 hrs. Upon arrival at the crash site, two of the fire-fighters were given a lift to the small island by a private boat. When they



arrived at 1215 hrs. they also realized that it was not possible to initiate any life-saving efforts. Response personnel from Øygarden fire department arrived shortly after.

- 1.15.2.4 Bergen fire department was alerted at 1201 hrs. and immediately deployed the fire and rescue boat *Sjøbrand*. The boat arrived at the crash site at approximately 1241 hrs. The first diver entered the water at 1305 hrs.
- 1.15.2.5 Shortly after the accident, large forces from the Police, the Norwegian Armed Forces, the Air Ambulance and Norwegian Civil Defense arrived.

## 1.16 Tests and research

### 1.16.1 Initial metallurgical examinations

- 1.16.1.1 The main rotor had separated from the helicopter. From the outset all parts belonging to the main gearbox (MGB), rotor mast and suspension bars became of special interest for further metallurgical investigation.
- 1.16.1.2 All available gear parts from the epicyclic module, the suspension bars and the conical housing, and debris from both MGB and oil cooler magnetic plugs were brought to the Norwegian Defence Laboratories (NDL) at Kjeller for an initial metallurgical investigation. At this stage, parts were only preserved and gently cleaned in order not to alter any fracture surfaces.
- 1.16.1.3 The first presentation documenting the investigation was given to the involved parties on 6 May 2016. The most important information concerned two segments of a second stage planet gear that together formed approximately one half of a planet gear. Witness marks on these two segments implied that they separated while other parts still had been in motion. While most of the fracture surfaces showed overload, possibly due to forces outside design criteria, one fracture surface showed different characteristics and was of particular interest, see left surface in Figure 27 and Figure 28.



Figure 27: The two fractured gear segments. Appearance of wear marks on the right, while not on the left indicate separation while other parts still have been in motion. Photo: AIBN/NDL



Figure 28: The fracture surface to the left in Figure 27, in general other surfaces appeared to be ductile overload, however, this surface indicated by the yellow arrow was of particular interest. Photo: AIBN/NDL

### 1.16.2 Locations for designating parts investigation

- 1.16.2.1 The AIBN decided where the different parts should be sent for further metallurgical investigation during a meeting with the involved parties at the AIBN premises on 10 - 13 May 2016:
- 1.16.2.2 Substantial parts of the MGB including the flexible mounting plate, the rotor mast, the rotor head, the airframe suspension bar fittings and most of the suspension bars were shipped to Airbus Helicopters in France (see Figure 29). The transport boxes were sealed and later opened at Airbus Helicopters witnessed by the AIBN. The subsequent investigation of the parts was performed under the supervision by the AIBN, the BEA and other involved parties.
- 1.16.2.3 All epicyclical reduction gear parts, parts from the conical housing and selected fracture surfaces from the suspension bars were carried by the AIBN to the metallurgical laboratory at QinetiQ, Farnborough in UK. QinetiQ had participated in the investigation following the G-REDL accident in 2009. Airbus Helicopters has participated with observers during these examinations, as well as performing separate examinations in Marignane, under the supervision of the AIBN and/or the BEA.



Figure 29: MRH, rotor mast and suspension bars packed for shipping (left photo) and as received at Airbus Helicopters (right photo). Photo: AIBN

### 1.16.3 Second stage planet gear

- 1.16.3.1 The two recovered segments of a second stage planet gear make up approximately half of a gear with part number 332A32.3335-07 and serial number 10-1292 (see Figure 27). The segments were later identified to have been located on stub axle marked number three on the second stage planet carrier.
- 1.16.3.2 Detailed examinations at QinetiQ showed that one fracture surface, initially described as a surface of particular interest was close to 100 % fatigue (see Figure 30 and Figure 31). Propagation of a fatigue crack requires repeated cyclic loading.

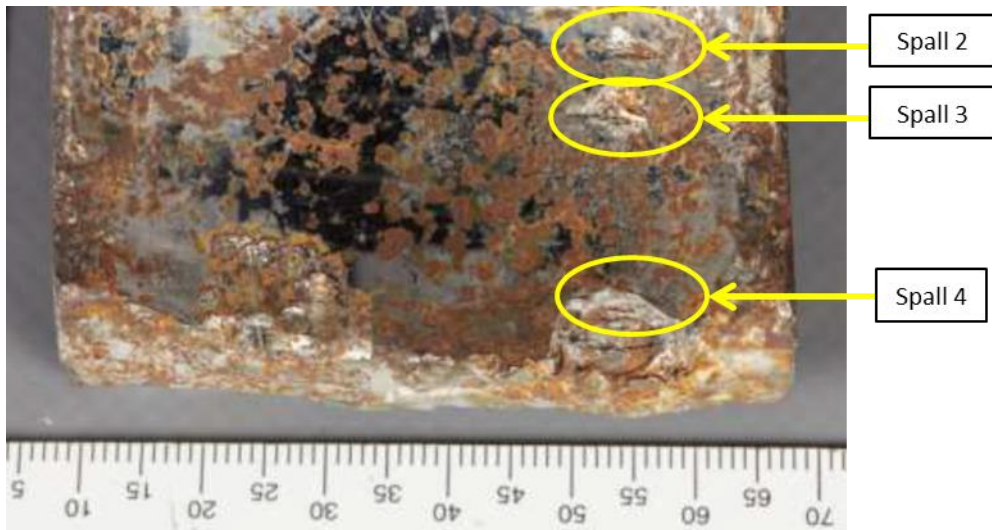

Figure 30: The fatigued surface as received at QinetiQ before cleaning. Along a line approximately 14 mm from the upper surface of the gear (right hand edge in photograph) some holes or spalls are observed, with the largest (named spall 4) located at the edge of the through-thickness fracture. Photo: AIBN/QinetiQ



Figure 31: The cleaned through-thickness fracture surface. The cleaning was performed using a combination of acetate replica stripping and inhibited HCl solution with ultrasonic agitation. Macro marks (beach marks) are visible towards the upper edge of the gear (left hand side in photograph). Photo: AIBN/QinetiQ

- 1.16.3.3 In order to describe the growth of the through-thickness fracture, the fracture surface was divided into three zones; Zone A, B and C. For Zone A and B the two teams (respectively Airbus Helicopters and QinetiQ/AIBN) agree on approximately 12 well-defined and less well-defined macro marks (beach marks). For zone C there is broad agreement on there



being approximately 29 features observed across the surface, but no agreement on what they relate to. See Figure 32.

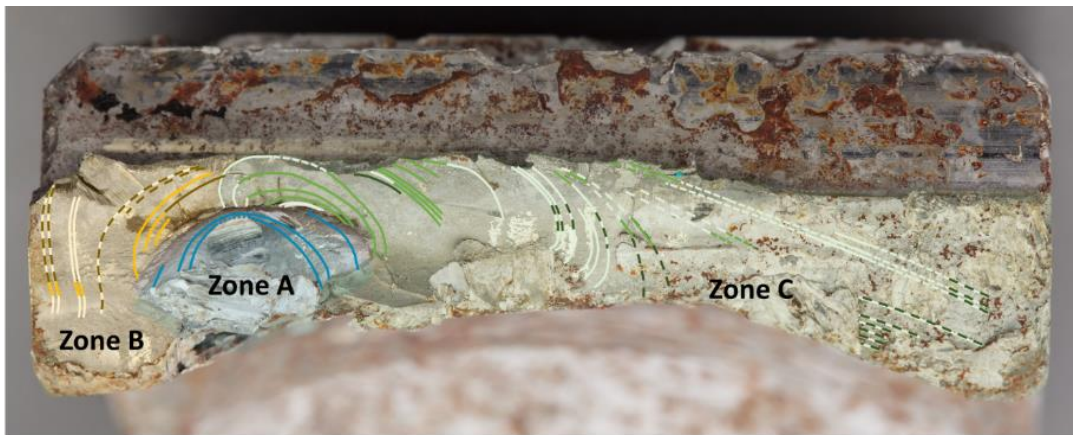

Figure 32: The fracture surface divided into three different zones. The macro marks /features observations are indicated: solid line – well defined, dashed line – less well defined. Photo: AIBN/QinetiQ and Airbus Helicopters

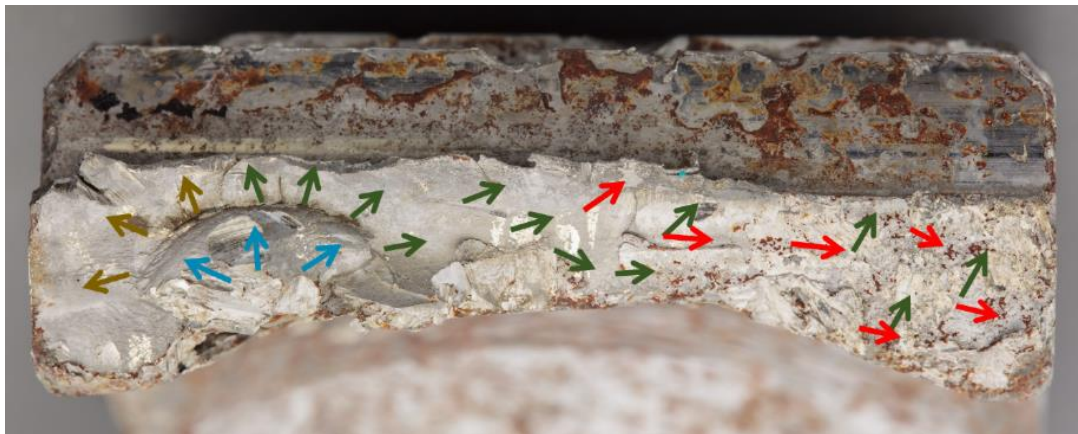

Figure 33: Crack propagation directions concluded from macro mark orientations in zones A (blue), B (brown) and C (green). Propagation in zone C concluded from striation and micro crack orientations is shown by the red arrows. Photo: AIBN/QinetiQ

1.16.3.4 Different crack propagation directions shown in zone C, (see Figure 33) depending on whether the orientation of the observed macro mark (beach mark) features or the striations / micro cracks are taken into account.

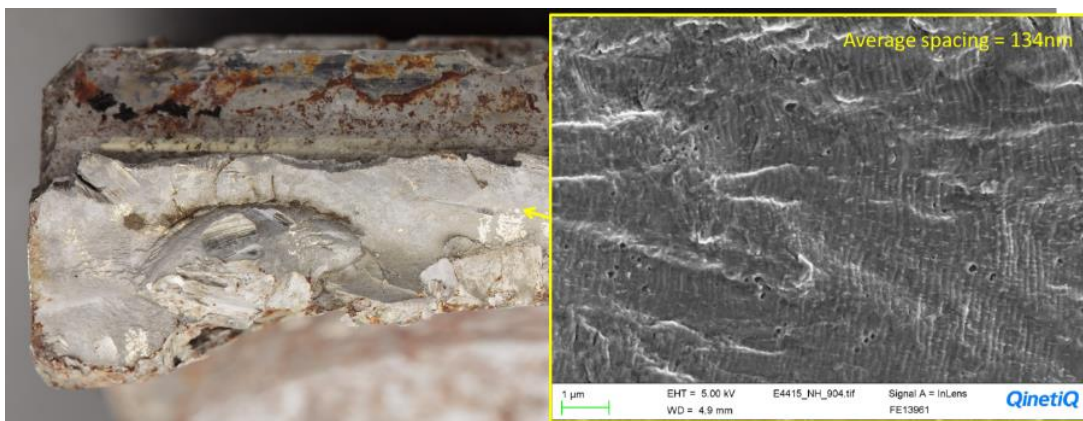

Figure 34: Fatigue crack progression marks – striations. Average spacing between the striations in this area are 134 nm. Photo: AIBN/QinetiQ

- 1.16.3.5 Well defined striations as shown above in Figure 34, were only observed in the central portion of the fracture in zone C. Clear striations were not positively identified in other areas of the fracture surface.
- 1.16.3.6 Establishing the propagation rate of a fatigue crack might allow you to determine the time taken for a crack to propagate to failure and hence could provide information on a potential inspection frequency to detect cracking before it becomes catastrophic. Both Airbus Helicopters and QinetiQ/AIBN have independently attempted to define fracture surface features which might be related to flight events such as engine stop-starts, take off and landings, torque changes etc. in order to estimate a crack propagation time. Airbus Helicopters has estimated the total time of the crack propagation for the Zone A, B and C to be at least 55 flight hours. To date there has been no agreement between Airbus Helicopters and QinetiQ/AIBN on the time taken for the crack to propagate.
- 1.16.3.7 Neither has it been possible to determine a conclusive propagation rate for the sub-surface phase of crack growth (see section 1.16.3.16).
- 1.16.3.8 On the outer race surface there are four spalls observed in front of the through-thickness fracture, numbered from one to four. The AIBN has been informed that the maximum Hertzian stress is along a line 14 mm from the upper edge of the planet gear and approximately 0.3 mm below the race surface. The four spalls appear to be located around this line (see Figure 35).

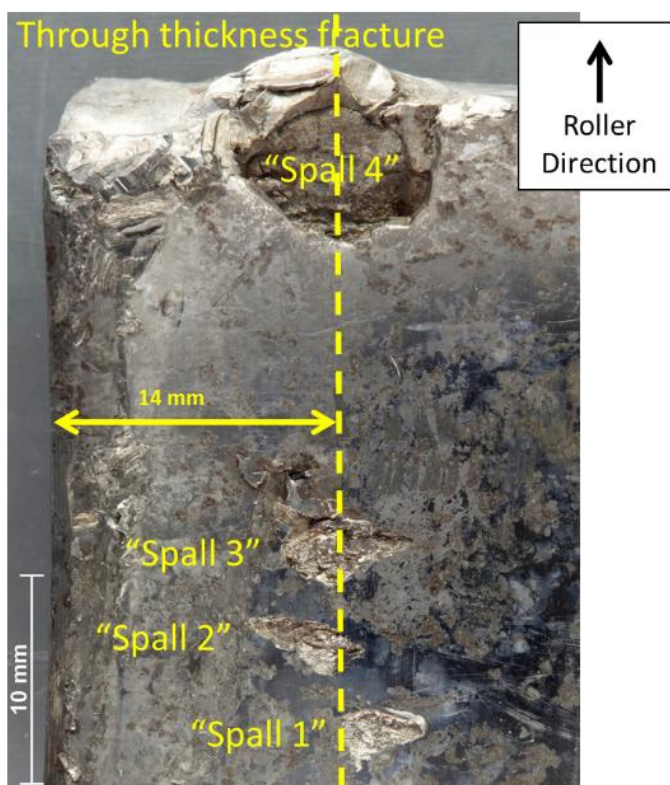

Figure 35: Showing spall one, two, three and four together with the max Hertzian stress line of 14 mm. Photo: AIBN/QinetiQ

- 1.16.3.9 Both the size and depth of the spalls increases from one to four (see Figure 35). Cracks are observed continuing below the surface of the spalls (an example is shown in Figure 36). A linear band containing micro-pits is observed in a band approximately 15 mm

from the upper edge of the planet gear. Both between spall one and two, and between two and three, there are some minor indents from particles.

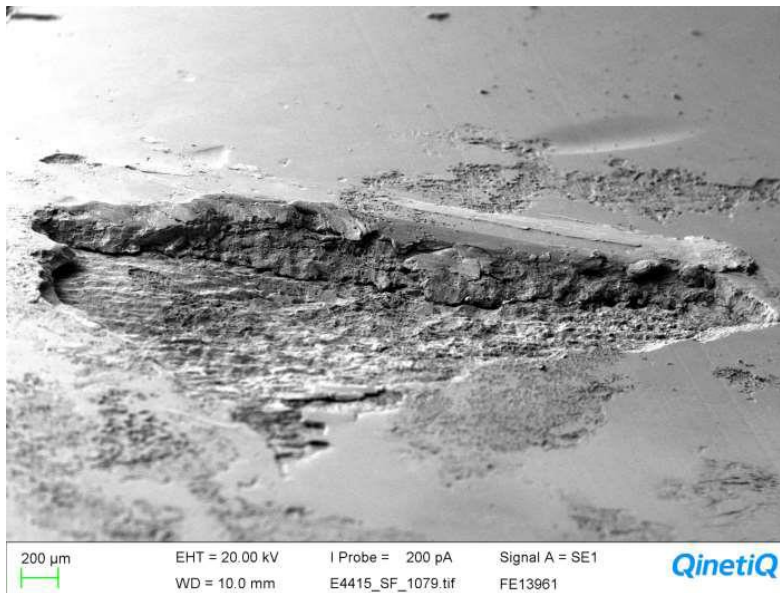

Figure 36: Spall one looking in the direction of spall two (in roller direction). A crack continuing under the surface is observed. Photo: AIBN/QinetiQ

- 1.16.3.10 Material conformity checks were made and the gear material was found to conform to specification. The average measured thickness of the carburized layer on the outer race surface was found to be 1.25 mm (specified thickness between 0.85 and 1.45 mm). The measured surface hardness of the outer race was 725HV10 (specified minimum hardness of 660HV10). The elemental composition was consistent with the specified 16NCD13 steel. The AIBN has received a material conformity certificate. Airbus Helicopters has informed that the link between the certificate and the actual gear is via ‘the parts manufacturer order’.
- 1.16.3.11 The compressive stress profiles were measured by Airbus Helicopters on three planet gears from LN-OJF, including two measurements of the fractured gear. These were compared with a similar profile made on a new FAG planet gear. There were no significant differences in the residual stress profiles. The results show a highly compressive surface stress, decreasing to approximately 40 % of the surface value at around 50 µm depth from the race surface. The compressive residual stress is relatively constant from this depth to approximately 600 µm from the race surface, from where it gradually decreases becoming tensile at around 1.8 to 2.0 mm from the race surface.
- 1.16.3.12 There were made visual inspections of the outer race in the vicinity of the fracture initiation looking for indents that possibly could stem from abnormal shock loads prior to the accident. There were no such findings.
- 1.16.3.13 Based on the assumption that there might be cracks or voids in the area between spall one and four it was important to get an understanding of the area before cutting the part for further examination. The piece was inspected using x-ray computed tomography (CT) (see Figure 37).
- 1.16.3.14 The first CT-scan was of the complete segment to the left in Figure 27. Due to the size of the segment the resolution was not sufficient to distinguish the presence of sub-surface



cracks. Based on the first scan, the segment was reduced in size to that shown in Figure 35 and re-scanned. Results are shown in Figure 38 and Figure 39. In order to further improve resolution the gear teeth were removed and further scanning performed.



Figure 37: The x-ray tomography set up. The part to be scanned is in the tube in the centre of the figure. Photo: AIBN

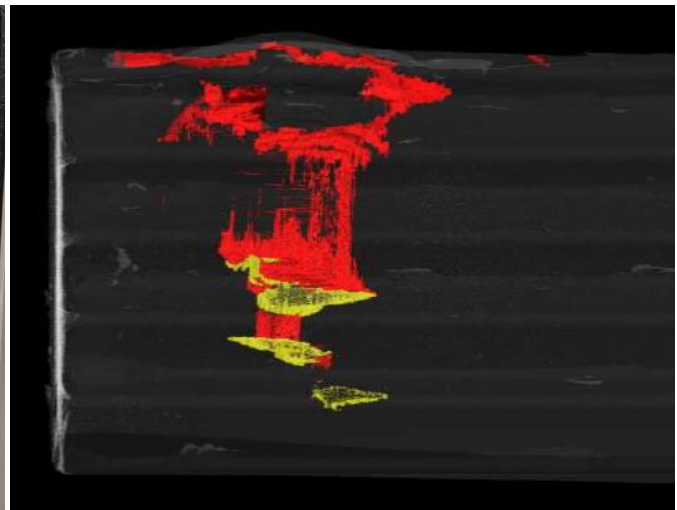

Figure 38: CT-scan of the specimen in Figure 35. The yellow areas are spall one, two and three. The red area indicates a sub-surface crack. Photo: Threshold CT-scan image from AIBN/Southampton University

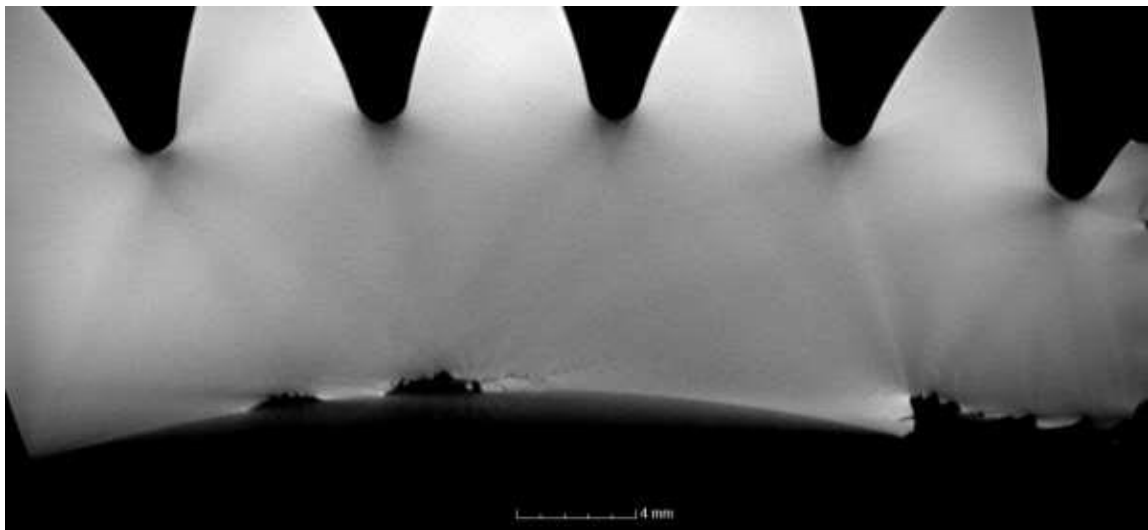

Figure 39: Longitudinal slice from CT-scan showing several cracks below the surface of the outer race. One crack runs below the surface between spalls (areas of surface damage). Photo: CT-scan from AIBN/Southampton University



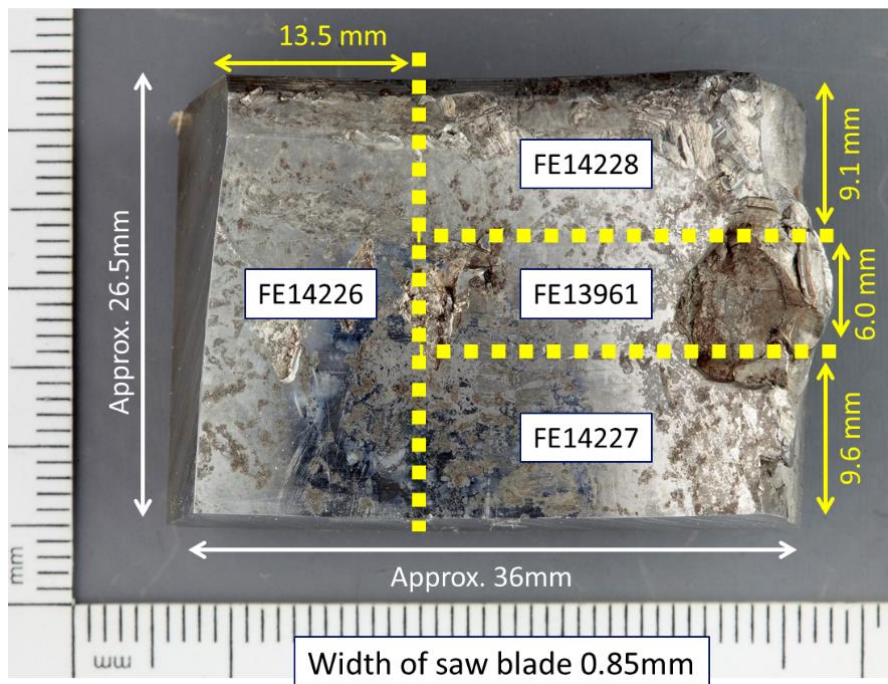

Figure 40: Cutting lay out based on CT-scan results (see Figure 37). FE13961 contains spall three and four, FE14226 contains spall one and two. Photo: AIBN/QinetiQ

- 1.16.3.15 Based on the CT-scan results, examples shown in Figure 38 and Figure 39, further cuts were agreed, see Figure 40. The teeth had been cut off prior to this. The cutting described in Figure 40 together with the cuts shown in Figure 45, made it possible to examine the crack path between spall three and four and also to open up the crack to examine the crack fracture surface (remove the race surface). The opened up crack fracture surface was examined in attempt to understand the propagation direction and speed.
- 1.16.3.16 Like the through-thickness fracture, the examination of this crack fracture surface has not been conclusive regarding crack growth rate. To date there has been no agreement between Airbus Helicopters and QinetiQ/AIBN on these features and what they relate to. Airbus Helicopters has estimated a propagation time of at least 18 flight hours. The QinetiQ/AIBN have seen deviations in depth but no beach marks. Regarding direction it must be compared with the further examination described in section 1.16.3.21. Further examination of the race surface half of the fracture in order to understand why cracks stop before producing spalls is being performed at Airbus Helicopters.
- 1.16.3.17 Examination of longitudinal polished microsections confirms that the cracks are propagating deeper into the gear material towards the through-thickness fracture, an example shown in Figure 42. Transverse microsections also show the crack to be propagating deeper towards the upper edge of the gear, see Figure 47.
- 1.16.3.18 The crack propagation is both trans-granular and inter-granular (see Figure 41). Trans-granular is a crack growth through the grains, while inter-granular is a crack growth following the grain boundaries. Cracks which initiated at or near the surface, within the hardened layer, are predominately inter-granular. As they get deeper into the bulk material, the fracture mode becomes increasingly trans-granular.
- 1.16.3.19 The sub-surface cracks that deviate towards the race surface stop before they reach the surface and thus do not release magnetic debris (spalls) to be detected on the magnetic

plugs. Investigation is in progress to determine if there is connection between the significantly higher compressive stress towards the race surface, see section 1.16.3.11, and the end of this crack growth. Other cracks deviate into the bulk material. One of these deviations into the bulk material has evolved into the through-thickness fracture, see Figure 42, Figure 43 and Figure 44. There appears to be a relationship between the deviation into the bulk material and the tooth root position, see Figure 44.



*Figure 41: The sub-surface crack propagation is both trans- and inter-granular. Polished surface etched with saturated Picric acid solution (with HCl). Roller direction to the left.  
Photo: AIBN/QinetiQ*

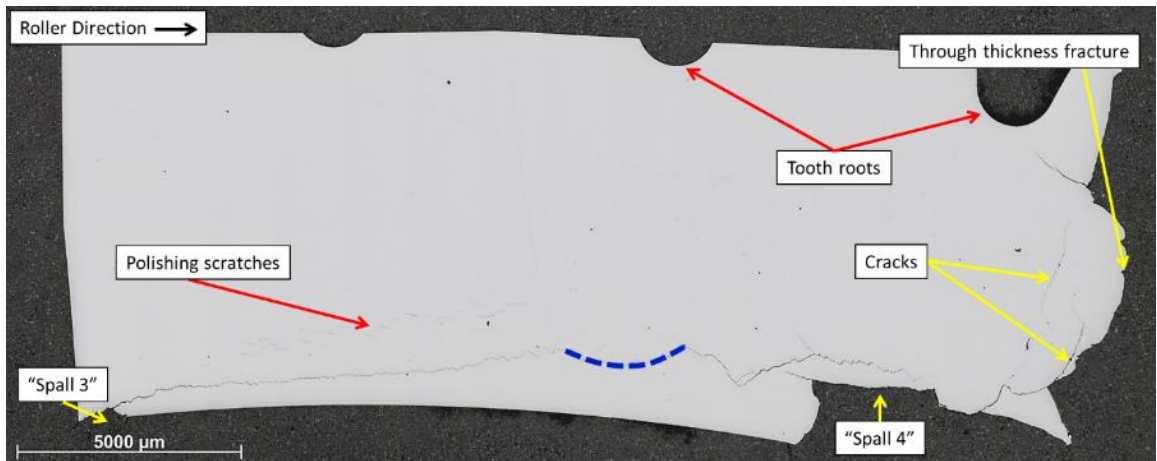

Figure 42: Sample FE13961 (see Figure 40). The microsection is 16.8 mm from upper edge. Cracks deviating towards the race surface stop and thus do not release particles. Photo: AIBN/QinetiQ

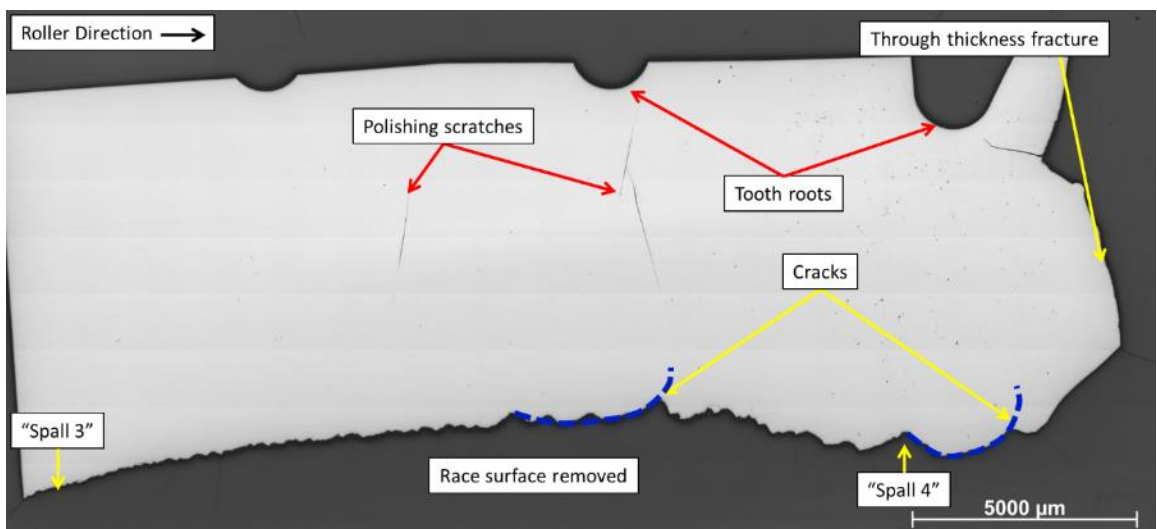

Figure 43: Sample FE13961 (see Figure 40). The microsection is further polished to 15 mm from upper edge. The microsection shows deviations towards the gear teeth roots. Photo: AIBN/QinetiQ

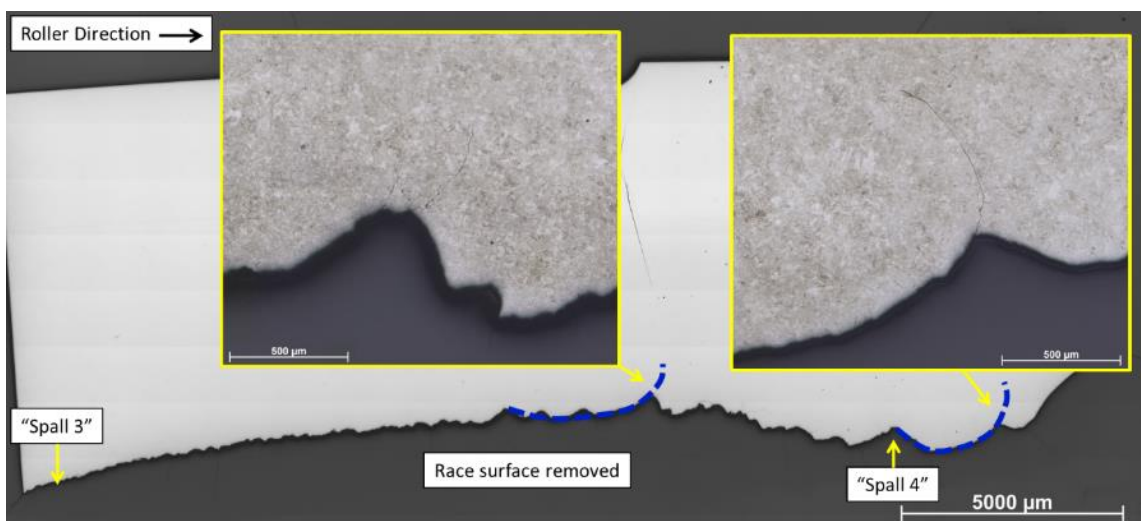

Figure 44: Sample FE13961 (see Figure 40). The microsection shows a close up of deviations towards the gear teeth roots. Photo: AIBN/QinetiQ



1.16.3.20 In order to examine spall one and two and the area between spall one, two and three, further cutting was made (see Figure 45).

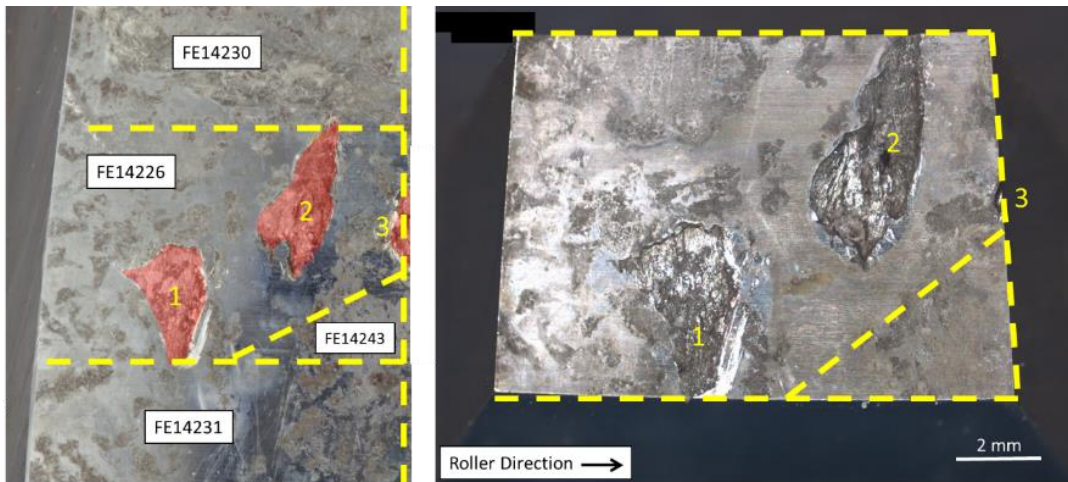

Figure 45: Figure showing cutting for examining spall one and two and the area around and between the spall one, two and three. Photo: AIBN/QinetiQ

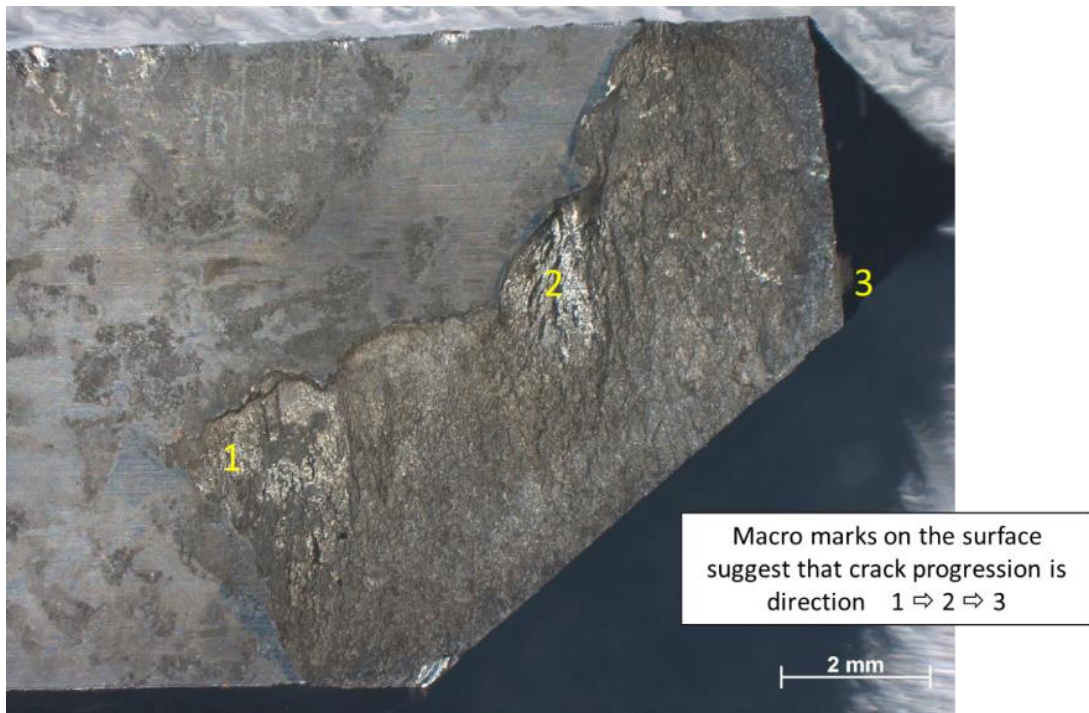

Figure 46: Figure showing the area between spall one, two and three after removal of the race surface. Photo: AIBN/QinetiQ

1.16.3.21 Spall one, two and three have a V-shaped profile with shallow entry angle indicative of initiation at or near the surface. Evidence of flaking on the edges of the spalls suggest growth by releasing debris. Indents observed on the race surface between the spalls might support this. Spall four is significantly larger than the other spalls, with steeper side walls which were found to be overload fracture. This indicates that the spall four might have been released as one piece and possibly at the time of break-up.

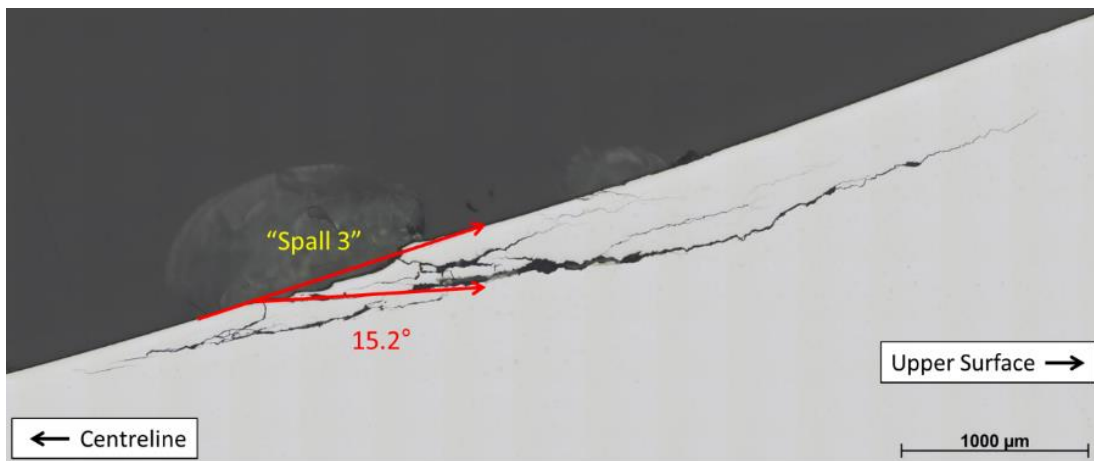

Figure 47: A transverse microsection of spall 3 with the angle crack propagation of 15.2°. Photo: AIBN/QinetiQ

- 1.16.3.22 The microsection between spall one and three shows that cracks originating from spall one is below those originating from spalls two and three. When opening up of the crack fracture surface between spall one, two and three, the macro marks suggest that crack progression is in the direction from one towards four. The cracks from spalls two and three merged with the crack from spall one. The crack from spall one would have progressed towards spall four regardless of spall two and three (see Figure 46). The AIBN is aware that Airbus Helicopters does not fully agree with this.
- 1.16.3.23 Examination of the outer race surface showed micro-pits in a band approximately 14 to 16 mm from the upper edge of the gear and with a centre at the 15 mm line. Sequential grinding and polishing of a transverse microsections within this band gave an indication on how these micro-pits could possibly be contributing to the formation and later growth of fatigue cracks. The transverse examination gave a crack growth angle rather similar to the transverse observation of spall three, i.e. between 14° and 16°, see Figure 47.
- 1.16.3.24 The same procedure in the longitudinal direction did also show crack growth in the roller direction, and the release of small particles.

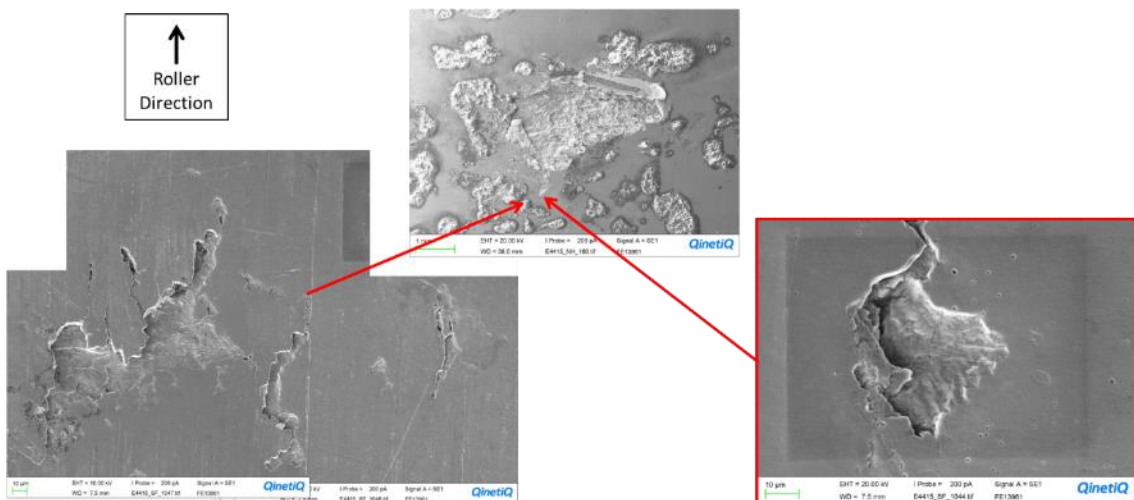

Figure 48: The micro-pits in the area in front of spall one and the pit (lower right) that appears to grow into the area of spall one (upper centre). Photo: AIBN/QinetiQ

1.16.3.25 The formation of spall one and the crack seems to have its origin at a micro-pit (see lower right in Figure 48). There are several micro-pits centralized along the same band approximately 15 mm from the upper edge of the gear. This seems to be slightly offset relative to the location where the roller contact force is largest, i.e. approximately 14 mm from the upper edge of the gear. The crack from spall one is propagating towards the 14 mm line. In order to get a more in-depth understanding, additional work will be performed in polishing into this micro-pit area.

#### 1.16.4 Second stage planet carrier

During a diving exercise in February 2017 the second stage planet carrier was found (see Figure 49). On the planet carrier the inner race of the fractured planet gear was still on the carrier but pulled off 20.4 mm. The lower rotor mast bearing was installed on the carrier. After cleaning, the inner race surface (see Figure 50) appears to be in good condition for further examination at QinetiQ together with the carrier and the bearing. The rotor mast splines have been visually inspected and no geometrical deviations were observed. Further investigation of the carrier is in progress.



Figure 49: The second stage planet carrier found in February 2017 shown after cleaning. The lower mast bearing is shown on top of the carrier. Photo: AIBN/QinetiQ



Figure 50: The inner race of the fractured planet gear after cleaning of the upper race (left in photo). Position on the carrier is given by the arrow. Photo: AIBN/QinetiQ



### 1.16.5 Conical housing and epicyclic ring gear

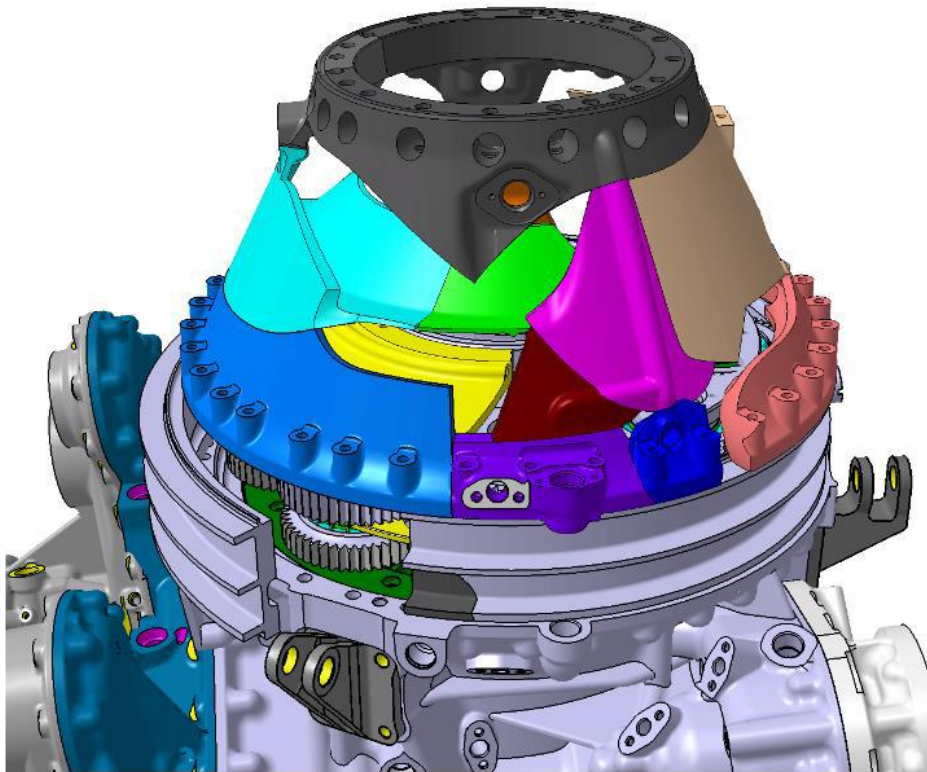

*Figure 51: Illustration of how the retrieved fragments of the conical housing are pieced together in order to look for break-up sequence/mechanism. Illustration: Airbus Helicopters*

- 1.16.5.1 The conical housing is made from an aluminum alloy casting and was found in many smaller segments. As these segments were gradually salvaged piece by piece, they were examined, scanned and documented. A complete conical housing was used as template at QinetiQ. Airbus Helicopters used their design and manufacturing data model in order to fit the different parts in the correct position (see Figure 51).
- 1.16.5.2 Examination of all the different conical housing segments together with the epicyclic ring gear, made it possible to determine the break-up sequence of the conical housing. Cracking of the fastener holes on the ring gear flange, suggests that the conical housing was intact when the fixed ring split and moved outwards, see Figure 52.
- 1.16.5.3 This was later compared with the witness marks on lower flange of the conical housing segments, which showed elongation of the bolt holes and shearing of the mounting bolts in the outboard direction as seen on the ring gear, see Figure 52. Examination of the upper conical housing segment, dark grey on Figure 51, shows elongation of all fastener holes in the same circumferential direction, see Figure 53. It was further established that a fracture had started in the lower part of the conical housing close to the ring gear opening between the blue and purple segments in Figure 51 and continued towards the top of the housing. Before reaching the top, the fracture bifurcated left and right propagating around the circumference forming the crack at the lower side of the grey segment in Figure 51.



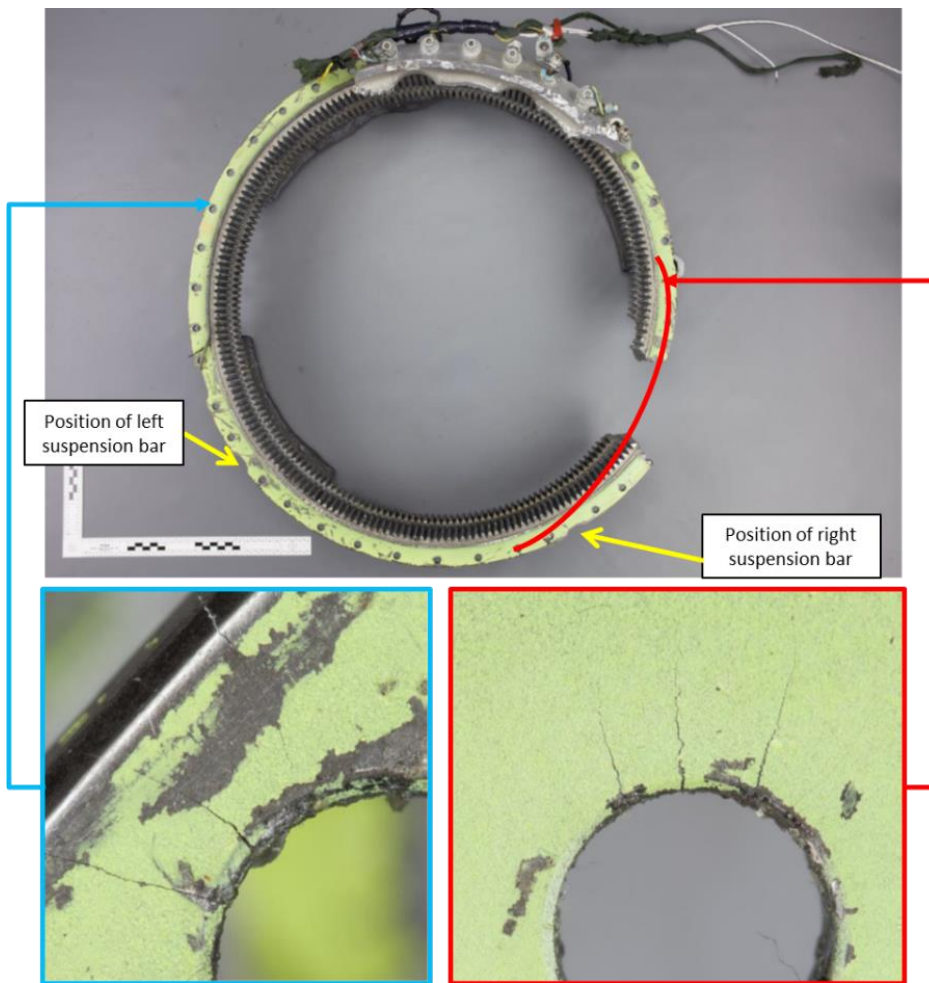

Figure 52: Epicyclic ring gear. Cracks at fastener holes suggests flange of conical housing were intact when fixed ring split and moved outwards. Photo: AIBN/QinetiQ

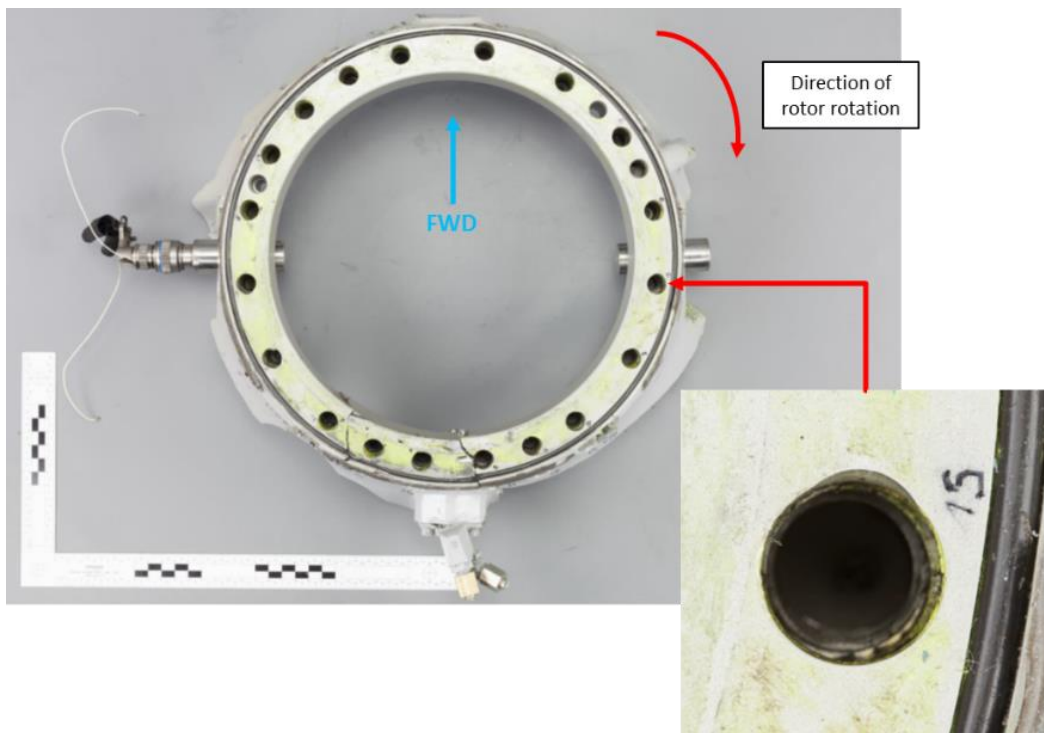

Figure 53: Top of conical housing. This segment of the conical housing was still attached to the rotor mast following the accident. Photo: AIBN/QinetiQ

1.16.5.4 To conclude; fracture examinations show indications of overload on all conical housing segments.

#### 1.16.6 Suspension bars and fittings

##### 1.16.6.1 *The two aft suspension bars*

The two aft suspension bars were still attached to the lift housing when the main rotor was found (see Figure 24). Both lower fuselage fittings had been torn out of the fuselage and were found with the main rotor. These parts were shipped, together with the rotor mast and rotor head, to Airbus Helicopters for examination, see Figure 29 and Figure 54.

For the left suspension bar all four safety pins were correctly installed in their respective clevis pins. For the right suspension bar both safety pins were correctly in place for the upper (lift yoke) mounts, while the strut fitting was found separated from the suspension bar and its clevis pin. Two segments of fractured safety pins were later found by the use of a metal detector at the site, see Figure 55. Metallurgical examination revealed that these two segments belonged to two different safety pins. Examination showed that they had failed in overload. From this it can be concluded that parts from all eight safety pins has been found were.

Both of the aft suspension bars were bent backwards and slightly towards the helicopter centerline, and both bars had indents from gears, see Figure 54.



Figure 54: Left and right aft suspension bars with clevis pins, safety pins (only one shown in each position) and fuselage fittings. Both suspension bars have indentations from gear teeth.  
Photo: AIBN



Figure 55: Two segments of safety pins found near the rotor mast. Metallurgical examination proved these to be from two different pins. Photo: AIBN/QinetiQ

### 1.16.6.2 *The forward suspension bar*

The only parts from the forward suspension bar that were recovered were the upper fractured mounting lug with its clevis, and two safety pins that were attached to the lift housing. These parts were brought to the QinetiQ laboratories for metallurgical examination, see Figure 56 (two safety pins shown on right photo).

Both top and bottom fractures were examined in a scanning electron microscope (SEM) and found to be overload. There was no evidence of progressive crack growth such as fatigue. Both top and bottom fractures exhibited necking and deformation consistent with tensile overload failure. The deformation was consistent with the lift strut bending in a port direction. More deformation (twisting) was observed on the bottom fracture, which suggests that the top of the lug failed first, allowing the strut to twist about the remaining bottom part of the lug before final failure. Bottom fracture face appears to be twisted approximately 10° anticlockwise, see Figure 57.



Figure 56: Upper forward suspension bar, part of the mounting lug, the bearing, the clevis pin (with only one of the two safety pins) and the safety pins. Here shown both as found at the rotor mast (right photo) and dismantled (left photo). Photo: AIBN

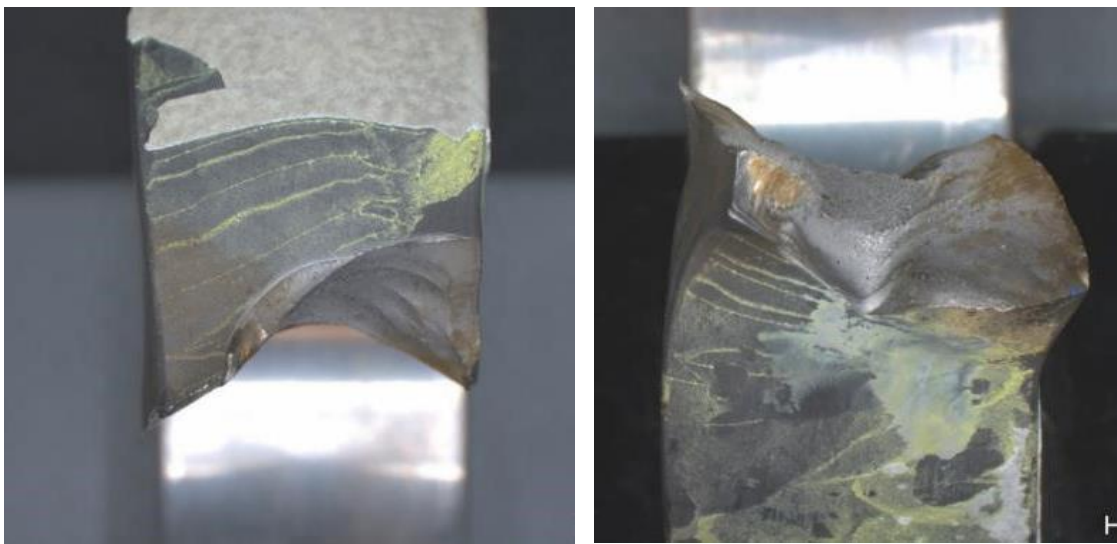

Figure 57: Upper forward suspension bar, mounting lug. Top fracture viewed from above (left photo). Bottom fracture viewed from below (right photo). Photo: AIBN/QinetiQ



### 1.16.6.3 *The lower fuselage fittings*

All three fuselage fittings had been ripped out of the engine deck structure and several bolts and nuts were not recovered. Several sifts through the wreckage were made to search for these parts.

Examination of the available bolts at Airbus Helicopters showed that these had been subject to tensile overload.

Inspection of available suspension bar airframe fittings, the mating airframe shim and plate, showed no major fretting, see Figure 58.



*Figure 58: The four bolts from the lower forward fuselage fitting protruding from the support plate.  
Photo: AIBN*

### 1.16.7 Flexible mounting plate

The flexible mounting plate was still attached to the MGB. The forward portion of the plate was bent up about 45° and was still attached to a piece of structure torn out of the transmission deck. The flexible plate aft attachment had detached from the fuselage plate (see Figure 59). 9 out of the total 17 attachment bolts were still in place. They had all failed due to overload in shear.



Figure 59: The flexible plate aft attachment had detached from the fuselage plate. 9 out of 17 bolts were still in place. Arrows indicating direction of overload in shear (towards the left relevant to the helicopter direction of flight). Photo: AIBN

#### 1.16.8 Investigation of metallic particles

##### 1.16.8.1 MGB magnetic plugs (chip detectors)

Only one of the three MGB magnetic plugs was found. The plug was brought to the Norwegian Defence Laboratories (NDL) for examination of the debris. The plug was from the MGB sump.

There was a lot of debris attached to the MGB sump plug, see Figure 60. All of the inspected particles appeared to have been generated during the break-up sequence. There were no particles recognized as having the shape of a spall or evidence of fatigue.

The MGB sump contained a large number of particles and these were examined at Airbus Helicopters. So far there is no indication that these particles provide useful information other than the observations made from the magnetic plug.

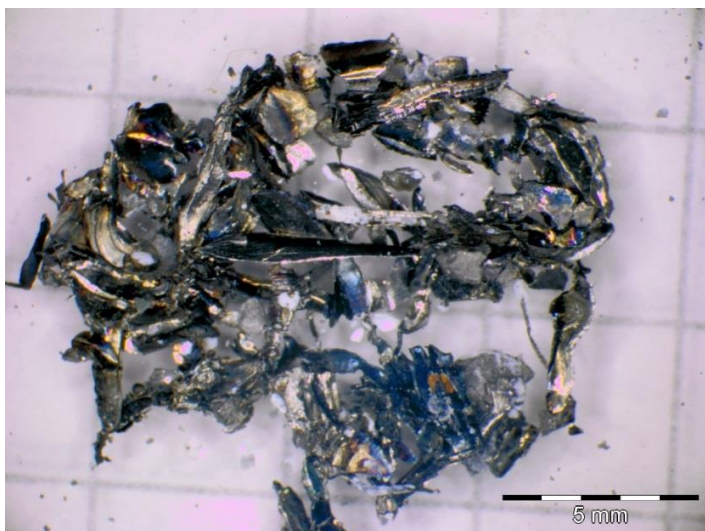

Figure 60: Metal particles from the MGB magnetic plug. Photo: AIBN/NDL

### 1.16.8.2 *Oil cooler chip detector*

The AIBN examined the particles sampled from the oil cooler magnetic plug to look for possible fracture surfaces and particle shapes. Due to the small size, particles from the magnetic plug were initially mounted on a carbon sticker for examination. The semi quantitative results based on Energy Dispersive X-Ray Spectrometer (EDS) for classifying these small particles in an accurate manner are difficult due to both contamination and geometry.

During the reexamination several EDS were taken from particles of interest, i.e. those possibly coming from the second stage planetary gear made from 16NCD13. Due to their damage, it was not possible to confirm if these particles were coming from the second stage planet gear spalling.

### 1.16.8.3 *Oil cooler*

The oil cooler was initially inspected for internal particles at the AIBN's premises in Lillestrøm. The oil cooler was filled up with white spirit and plugged. It was then turned over several times and emptied through a filter. Several particles were discovered and these were sent to the Norwegian Defence Laboratories (NDL) for analysis in agreement with Airbus Helicopters.

The metallic particles from inside of the oil cooler appeared larger than those on the magnetic plug. These larger particles were mounted in epoxy and polished for material qualification using EDS. Thus the EDS obtained are more conclusive. Since these particles were fixed in epoxy, examination beside what can be done from the "upper" side was not feasible and thus it was impossible to conclude whether it was spalling. A majority of the metallic particles obtained inside the oil cooler were aluminum.

The oil cooler was later sent to Airbus Helicopters for further investigations. During additional cleaning processes, performed in accordance with the procedure described in the latest Emergency Alert Service Bulletins (EASB, see section 1.18.1.16), particles of 16NCD13 were found, notably one particle with a surface area of 1.8 mm<sup>2</sup> (length 1.8 mm, width 1.3 mm). During all of the ten additional cleaning processes at Airbus Helicopters more particles were salvaged. The analysis of the particles recovered during these additional cleaning processes has revealed 4.69 mm<sup>2</sup> (5 particles) identified by Airbus Helicopters as 16NCD13 spalls and 18 mm<sup>2</sup> of further 16NCD13 particles which could be spalls but too damaged to be affirmative. These results remain to be discussed in detail between Airbus Helicopters and the AIBN.

## 1.17 **Organizational and management information**

### 1.17.1 Influences of the airworthiness of LN-OJF

Figure 61 illustrates the organizations with an influence of the airworthiness of LN-OJF.

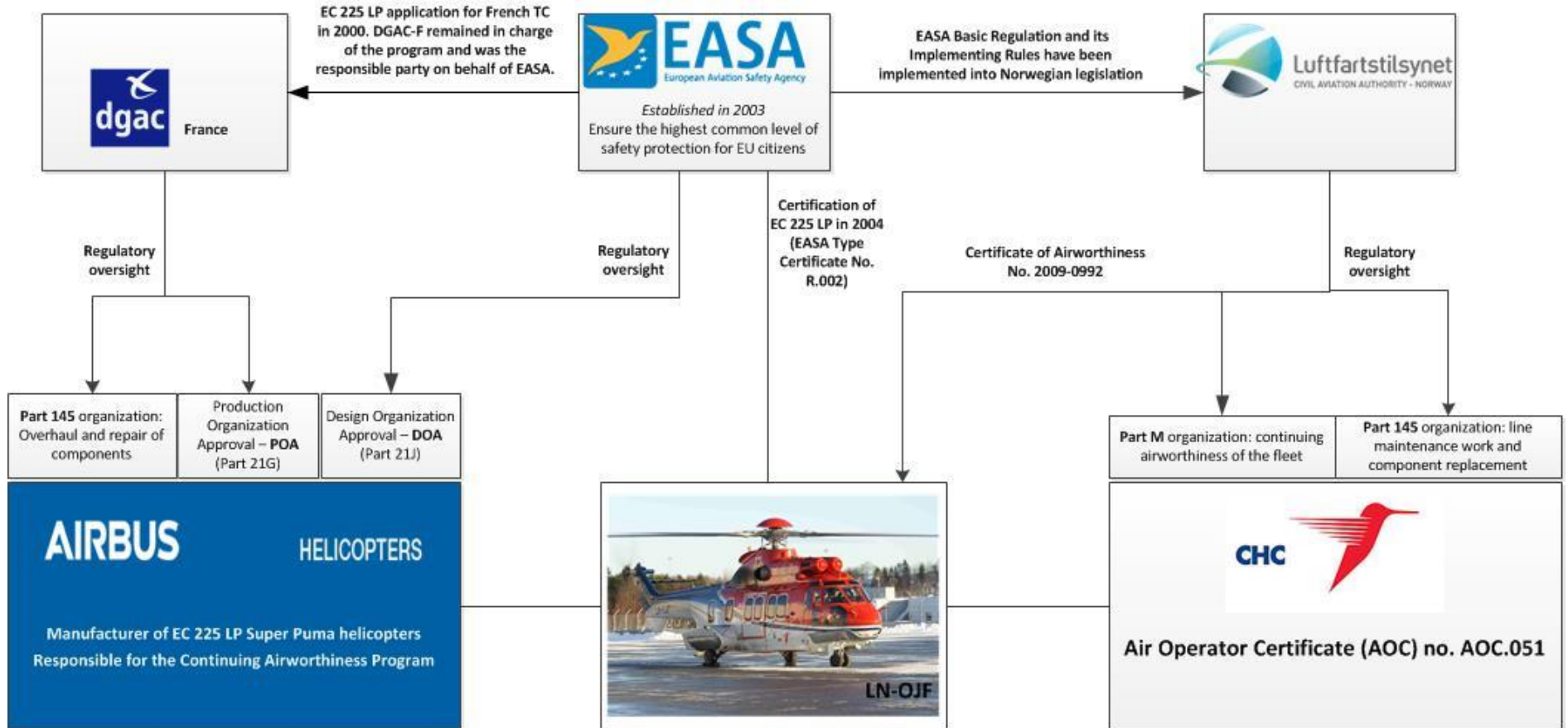

Figure 61. Influences on the airworthiness of LN-OJF. Illustration: AIBN.



### 1.17.2 The operator

- 1.17.2.1 CHC Helikopter Service AS dates back to 1956, when Scancopter Service AS was established. In 1999, Canadian Holding Company purchased the company and the Norwegian company became part of CHC's global helicopter operations.
- 1.17.2.2 CHC Helikopter Service is authorised to conduct commercial air operations in accordance with Air Operator Certificate (AOC) No. NO.AOC.051 issued by the Civil Aviation Authority - Norway.
- 1.17.2.3 CHC Helikopter Service's head office is at Stavanger Airport Sola. The company has bases in Stavanger, Bergen, Florø, Kristiansund and Brønnøysund, in addition to offshore installations on Valhall, Statfjord, Oseberg and Heidrun. The company has approximately 400 employees in total.
- 1.17.2.4 At the time of the accident, CHC Helikopter Service had 5 AS332L/L1, 7 AS332L2, 12 EC225 and 15 S-92A.

### 1.17.3 Organization of continuing airworthiness

- 1.17.3.1 CHC Helikopter Service's Part M organization has the responsibility for the maintenance of the fleet according to the requirements of continuing airworthiness (see chapter 1.6.10.1). The organization consisted of in total 17 persons, mainly located in Stavanger.
- 1.17.3.2 The Part M organization develops and updates the maintenance programs for the helicopter types in operation by CHC Helikopter Service. The aircraft maintenance programs (AMP) are based on the manufacturers' and the aviation authorities' recommendations and requirements. In addition, the company's own experiences based on the operational environment of the helicopter may also cause the AMP to be amended. Further, the company's Part M organization plans the maintenance activities, monitors the Health and Usage Monitoring Systems (HUMS) installed in the helicopters and performs Airworthiness Review of the helicopters.
- 1.17.3.3 CHC Helikopter Service's Part 145 organization performs line and base maintenance work and component replacements issued by the Part M organization. The Part 145 organization does also rectify failures and defects.
- 1.17.3.4 Base maintenance of helicopters, and repair and overhaul of components are performed by Heli One, which is a Part 145 organization and a subsidiary of CHC.

### 1.17.4 CAA Norway

- 1.17.4.1 CAA Norway is the national aviation safety regulator. Among other things, the CAA carries out oversight of Norwegian helicopter companies.
- 1.17.4.2 The last flight operations inspection of CHC Helikopter Service main base was carried out in September 2014. The last Part-145 inspection was carried out in December 2014 and the Part-M inspection in January 2015.
- 1.17.4.3 Norway is a member of the European Free Trade Association (EFTA) and a non-voting member state of EASA. Most EU-regulation and directives like the EASA Basic

Regulation (EC) No 216/2008 and its Implementing Rules have been implemented into Norwegian legislation.

#### 1.17.5 European Aviation Safety Agency (EASA)

##### 1.17.5.1 *General*

EASA is an Agency of the European Union (EU) established in 2003. The Agency has 32 member states. Its primary mission is to promote the highest common standards of safety and environmental protection in civil aviation.

The following text is selected information from the EASA website<sup>12</sup> of relevance to the investigation:

##### 1.17.5.2 *Agency Rules*

In order to assist in the implementation of the relevant EU legislation EASA produces the following documentation referred to as Agency Rules:

- Certification Specifications (CS, including the general AMC-20).
- Acceptable Means of Compliance (AMC) & Guidance Material (GM) to a rule.

The above are introduced via the publication of a cover document referred to as Agency decisions.

##### 1.17.5.3 *Type certification*

Before a newly developed aircraft model may enter into operation, it must obtain a type certificate from the responsible aviation authority. Since 2003, EASA is responsible for the certification of aircraft in the EU and the EFTA-zone. This certificate testifies that the type of aircraft meets the safety requirements set by the European Union.

According to EASA there are 4 steps in the type-certification process:

1. Technical Familiarization and Certification Basis
2. Establishment of the Certification Program
3. Compliance demonstration
4. Technical closure and issue of approval

##### 1.17.5.4 *Airworthiness Directives*

Airworthiness Directives are issued by EASA, acting in accordance with the Basic Regulation<sup>13</sup>. In accordance with Commission Regulation (EU) No 1321/2014 (Annex I, M.A.301), the continuing airworthiness of an aircraft shall be ensured by accomplishing any applicable ADs. Consequently, no person may operate an aircraft to which an AD

---

<sup>12</sup> <https://www.easa.europa.eu/>

<sup>13</sup> Regulation (EC) No 216/2008 of 20/02/2008 on common rules in the field of civil aviation and establishing a European Aviation Safety Agency, and repealing Council Directive 91/670/EEC, Regulation (EC) No 1592/2002 and Directive 2004/36/E.

applies, except in accordance with the requirements of that AD unless otherwise specified by the Agency or agreed with the Authority of the State of Registry.

ADs applicable to an EASA approved type certificate are those ADs which have been issued by EASA through Agency decisions, or adopted by the Agency. The dissemination of airworthiness directives to aircraft owners is a responsibility of the State of Registry and does not belong to the Agency.

#### 1.17.5.5 *Design and production organizations (Part 21)*

According to Commission Regulation (EU) No 748/2012, organizations that design aircraft; changes to aircraft; repairs of aircraft; and parts and appliances need to fulfill the requirements as defined in Annex 1 (which is called Part 21). Part 21 (J) relates to the Design Organization Approval (DOA) and Part 21 (G) relates to the Production Organization Approval (POA). Such organizations need to demonstrate that they have the right organization, procedures, competencies and resources.

For the EC 225 LP, the EASA holds Part 21 (J) responsibility for the regulatory oversight of the DOA holder and the DGAC-F is responsible for the Part 21 (G) oversight of the POA holder.

The EASA Form 1 (mentioned in chapter 1.6.10.4) is the Authorized Release Certificate issued by an approved manufacturing or maintenance organization (POA holder or Part-145 organization) for stating that a product, a part, or a component was manufactured or maintained in accordance with approved design or maintenance data. It also states eligibility.

#### 1.17.5.6 *Approved maintenance organizations (Part-145 and Part-M)*

According to Commission Regulation (EU) No 1321/2014, the continuing airworthiness of aircraft and components shall be ensured in accordance with the requirements as defined in Annex I (which is called Part-M). Organizations and personnel involved in the continuing airworthiness of aircraft and components, need to fulfill these requirements. Maintenance of large aircraft, aircraft used for commercial air transport and components thereof shall be carried out by a Part-145 approved maintenance organization (defined in Annex 2).

### 1.17.6 Certification process and requirements

#### 1.17.6.1 *Certification of the AS 332 L2*

The design of the AS 332 L2 is based on the earlier AS 332 L1, certified in 1985 by the DGAC-F. This was in turn based on the original type acceptance of the SA 330 F (DGAC type certificate no. 56) issued in 1970.

The AS 332 L2 was originally certified by the French civil aviation authorities (DGAC-F) in 1991. FAR 29 amendments 1 to 24 were used as the certification basis. At that time, FAR 29.571 was a requirement which dealt with the fatigue evaluation of structure including the main rotor drive system. The text of that requirement was:

*Sec. 29.571**Fatigue evaluation of flight structure.*

*(a) General. Each portion of the flight structure (the flight structure includes rotors, rotor drive systems between the engines and the rotor hubs, controls, fuselage, and their related primary attachments) the failure of which could be catastrophic, must be identified and must be evaluated under paragraph (b), (c), (d) or (e) of this section. The following apply to each fatigue evaluation:*

- (1) The procedure for the evaluation must be approved.*
- (2) The locations of probable failure must be determined.*
- (3) Inflight measurement must be included in determining the following:*
  - (i) Loads or stresses in all critical conditions throughout the range of limitations in Sec. 29.309, except that maneuvering load factors need not exceed the maximum values expected in operation.*
  - (ii) The effect of altitude upon these loads or stresses.*
- (4) The loading spectra must be as severe as those expected in operation and must be based on loads or stresses determined under subparagraph (3) of this paragraph.*

*(b) Fatigue tolerance evaluation. It must be shown that the fatigue tolerance of the structure ensures that the probability of catastrophic fatigue failure is extremely remote without establishing replacement times, inspection intervals or other procedures under [Sec. A29.4 of Appendix A.]*

*(c) Replacement time evaluation. It must be shown that the probability of catastrophic fatigue failure is extremely remote within a replacement time furnished under [Sec. A29.4 of Appendix A.]*

*(d) Failsafe evaluation. The following apply to failsafe evaluations:*

- (1) It must be shown that all partial failures will become readily detectable under inspection procedures furnished under Sec. 29.1529(a)(2).*
- (2) The interval between the time when any partial failure becomes readily detectable under subparagraph (1), and the time when any such failure is expected to reduce the remaining strength of the structure to limit or maximum attainable loads (whichever is less), must be determined.*
- (3) It must be shown that the interval determined under subparagraph (2) is long enough, in relation to the inspection intervals and related procedures furnished under Sec. 29.1529(a)(2), to provide a probability of detection great enough to ensure that the probability of catastrophic failure is extremely remote.*

*(e) Combination of replacement time and failsafe evaluations. A component may be evaluated under a combination of paragraphs (c) and (d) of this section. For such component it must be shown that the probability of catastrophic failure is extremely remote with an approved combination of replacement time, inspection intervals, and related procedures furnished under Sec. 29.1529(a)(2).*

*Amdt. 29-20, Eff. 10/14/80*

Extremely remote is defined as a probability of occurrence that is less than  $1 \times 10^{-7}$  but greater than  $1 \times 10^{-9}$  per flight hour.

The G-REDL report describes that parts of the AS 332 L2 structure were certificated against either 29.571 paragraph b) fatigue tolerance evaluation or paragraph c) replacement time evaluation. The second stage planet gears were certified against paragraph c) replacement time evaluation. At the time of certification the manufacturer applied service life limits and design assessments to demonstrate to the regulator that the probability of occurrence was extremely improbable (less than  $1 \times 10^{-9}$ ). In addition, the approved maintenance program included in-service condition monitoring of the gearbox.

According to the G-REDL report certification testing of AS 332 L2 demonstrated that when the slow degradation process of a bearing began to release particles, the epicyclic chip detector collected sufficient particles to give adequate warning of a problem using the prescribed inspection interval for the detector.

In 1989<sup>14</sup> FAR 29.571 was significantly amended to introduce flaw tolerance requirements and was intended to reduce catastrophic fatigue failures in transport category rotorcraft.

#### 1.17.6.2 *Certification of the EC 225 LP*

The certification program of the EC 225 LP helicopter commenced with the application to DGAC-F for French Type Certificate (TC) in November 2000<sup>15</sup>. Since the establishment of EASA on 28 September 2003, the type certification was transferred to EASA. DGAC-F remained in charge of the program and the responsible party on behalf of EASA to achieve compliance findings under the current French national process. The EC 225 LP was officially certified by EASA 27 July 2004 (EASA Type Certificate No. R.002).

The initial target for TC issuance was scheduled for March 2003 but this date was postponed three times by Airbus Helicopters due to development and certification difficulties mainly related to the new Makila 2A engine. Finally the total program duration was approximately 3 years and 8 months which remained within the time limit of five years allowed to large rotorcraft.

At the time of application for certification of the EC 225 LP in 2000, JAR 29 Change 1, effective 1 December 1999, was the certification basis. However, under the reversions granted in accordance with the Changed Product Rule (CPR) (now 21.A.101) of Part 21, fatigue evaluation of certain structures was carried out to the earlier FAR 29.571 requirements in amendment 24. According to the CPR principles any metallic principal structural elements (PSE) which were not significantly changed from the previous AS 332 L2 design were certified against the earlier requirements. As the first and second stage planet gears and sun gear in the epicyclic module had not changed from the AS 332 L2, the earlier requirements were used.

---

<sup>14</sup> 29/11/1989 FAR 29 amdt. 28.

<sup>15</sup> An advisor from the CAA-UK and a specialist from German LBA were seconded to the certification team through arrangement signed between those Authorities and the DGAC-F.



### 1.17.6.3 Current certification requirements (CS-29)

The current certification requirements are laid out in EASA Certification Specifications for Large Rotorcraft (CS-29). The following specific paragraphs are of interest:

CS 29.571 Fatigue tolerance evaluation of metallic structure

CS 29.602 Critical parts

CS 29.917 Rotor drive system - Design

CS 29.923 Rotor drive system – Rotor drive system and control mechanism tests

CS 29.927 Rotor drive system – Additional tests

#### CS 29.571 Fatigue tolerance evaluation of metallic structure

The initial 2003 issue<sup>16</sup> of CS 29.571 *Fatigue evaluation of structure* stated in section (a) *General* that the catastrophic failure of principal structural elements (PSE) within the rotor drive train due to the presence of fatigue must be avoided. The text further stated:

*(b) Fatigue tolerance evaluation (including tolerance to flaws). The structure must be shown by analysis supported by test evidence and, if available, service experience to be of fatigue tolerant design. The fatigue tolerance evaluation must include the requirements of either subparagraph (b)(1), (2), or (3), or a combination thereof, and also must include a determination of the probable locations and modes of damage caused by fatigue, considering environmental effects, intrinsic/discrete flaws, or accidental damage. Compliance with the flaw tolerance requirements of sub-paragraph (b) (1) or (2) is required unless it is established that these fatigue flaw tolerant methods for a particular structure cannot be achieved within the limitations of geometry, inspectability, or good design practice. Under these circumstances, the safe-life evaluation of sub-paragraph (b)(3) is required.*

*(1) Flaw tolerant safe-life evaluation. It must be shown that the structure, with flaws present, is able to withstand repeated loads of variable magnitude without detectable flaw growth for the following time intervals:*

*(i) Life of the rotorcraft; or*

*(ii) Within a replacement time furnished under paragraph A29.4 of appendix A.*

*(2) Fail-safe (residual strength after flaw growth) evaluation. It must be shown that the structure remaining after a partial failure is able to withstand design limit loads without failure within an inspection period furnished under paragraph A29.4 of appendix A. Limit loads are defined in CS 29.301 (a).*

*(i) The residual strength evaluation must show that the remaining structure after flaw growth is able to withstand design limit loads without failure within its operational life.*

---

<sup>16</sup> ED Decision no. 2003/16/RM of 14 November 2003 on Certification Specifications for Large Rotorcraft (CS-29).

*(ii) Inspection intervals and methods must be established as necessary to ensure that failures are detected prior to residual strength conditions being reached.*

*(iii) If significant changes in structural stiffness or geometry, or both, follow from a structural failure or partial failure, the effect on flaw tolerance must be further investigated.*

*(3) Safe-life evaluation. It must be shown that the structure is able to withstand repeated loads of variable magnitude without detectable cracks for the following time intervals:*

*(i) Life of the rotorcraft; or*

*(ii) Within a replacement time furnished under Paragraph A29.4 of appendix A.*

This showed that inspection methods must be sufficiently robust to detect the deterioration of a critical component before the ability of the component to carry its design load is compromised. However, if under specific circumstance linked to inspectability (i.e. case of element located inside the gearbox) the sub-paragraph (b) (1) or (2) could not be applied, and the safe-life evaluation of sub-paragraph (b) (3) *Safe-life evaluation* is required.

Advances in the understanding of fatigue tolerance evaluation led to the formation of a joint working group between the Joint Aviation Authority (JAA, predecessor to EASA), the Federal Aviation Administration (FAA), the rotorcraft industry and the Technical Oversight Group for Ageing Aircraft (TOGAA) in 2000. The working group evaluated proposals from the industry, TOGAA recommendations, and the continuing activities and results of rotorcraft damage tolerance research and development. As a result of this review, the working group recommended changes to the fatigue evaluation requirements for CS 29.571. This resulted in the publication of EASA Notice of Proposed Amendment 2010-06, published on 27 May 2010, which proposes to introduce improvements in the ability to avoid catastrophic failures of primary structure, including rotor transmission components.

On 11 December 2012 EASA published<sup>17</sup> CS-29 / Amendment 3 with the new CS 29.571 *Fatigue tolerance evaluation of metallic structure*. The following are the current certification requirements:

*(e) Each fatigue tolerance evaluation must include:*

*(1) In-flight measurements to determine the fatigue loads or stresses for the PSEs identified in sub-paragraph (d) in all critical conditions throughout the range of design limitations required in CS 29.309 (including altitude effects), except that manoeuvring load factors need not exceed the maximum values expected in operations.*

*(2) The loading spectra as severe as those expected in operations based on loads or stresses determined under sub-paragraph (e)(1), including external*

---

<sup>17</sup> ED Decision 2012/022/R amending ED Decision 2003/16/RM on Certification Specifications for Large Rotorcraft (CS-29).

*load operations, if applicable, and other high frequency powercycle operations.*

*(3) Take-off, landing, and taxi loads when evaluating the landing gear (including skis and floats) and other affected PSEs.*

*(4) For each PSE identified in subparagraph (d), a threat assessment, which includes a determination of the probable locations, types, and sizes of damage taking into account fatigue, environmental effects, intrinsic and discrete flaws, or accidental damage that may occur during manufacture or operation.*

*(5) A determination of the fatigue tolerance characteristics for the PSE with the damage identified in sub-paragraph (e)(4) that supports the inspection and retirement times, or other approved equivalent means.*

*(6) Analyses supported by test evidence and, if available, service experience.*

*(f) A residual strength determination is required that substantiates the maximum damage size assumed in the fatigue tolerance evaluation. In determining inspection intervals based on damage growth, the residual strength evaluation must show that the remaining structure, after damage growth, is able to withstand design limit loads without failure.*

*(g) The effect of damage on stiffness, dynamic behaviour, loads and functional performance must be considered.*

*(h) The inspection and retirement times or approved equivalent means established under this paragraph must be included in the Airworthiness Limitation Section of the Instructions for Continued Airworthiness required by CS 29.1529 and paragraph A29.4 of Appendix A.*

*(i) If inspections for any of the damage types identified in sub-paragraph (e)(4) cannot be established within the limitations of geometry, inspectability, or good design practice, then supplemental procedures, in conjunction with the PSE retirement time, must be established to minimize the risk of occurrence of these types of damage that could result in a catastrophic failure during the operational life of the rotorcraft.*

*[Amdt 29/3]*

### CS 29.602 Critical parts

CS 29.602 requires the Part 21 organization (Airbus Helicopters) to define the design and the manufacturing process of a Critical part (the second stage planet gear):

*(a) Critical part - A critical part is a part, the failure of which could have a catastrophic effect upon the rotorcraft, and for which critical characteristics have been identified which must be controlled to ensure the required level of integrity.*

*(b) If the type design includes critical parts, a critical parts list shall be established. Procedures shall be established to define the critical design characteristics, identify processes that affect those characteristics, and identify the design change and process change controls necessary for showing compliance with the quality assurance requirements of Part-21.*

#### 1.17.6.4 *Assessment of the MGB against CS 29.571*

The AAIB investigation into the G-REDL accident found that the phenomenon of crack formation within the carburized layer of the outer planet gear race had not been considered during the design and certification of the AS 332 L2 and EC 225 LP epicyclic reduction gearbox module or the development of the approved maintenance program of the MGB.

The AAIB stated in the G-REDL report (on page 95) that “*although the design satisfied the certification requirement in place at the time of certification*”, and further “*it would appear that if the current requirements [CS 29.571 issued in 2003] were applicable they may not have been met*”. The report refers to EASA Notice of Proposed Amendment 2010-06 which provides additional guidance on the determination of suitable inspection techniques and intervals, and subsequent resulted in the new CS 29.571 *Fatigue tolerance evaluation of metallic structure* (see chapter 1.17.6.3). During the earlier stages of the G-REDL investigation several safety recommendations were made regarding the continued airworthiness of the MGB. According to the G-REDL report, these resulted in EASA and the helicopter manufacturer issuing changes to the maintenance requirements and a re-evaluation of the design of the second stage planet gear. Given this, safety recommendation SR 2011-036 was issued to EASA in the final report in order to “*re-evaluate the continued airworthiness of the main rotor gearbox fitted to the AS332 L2 and EC225 helicopters to ensure that it satisfies the requirements of Certification Specification (CS) 29.571 and EASA Notice of Proposed Amendment 2010-06*” (see chapter 1.18.4.4).

#### 1.17.7 The safety recommendation process

- 1.17.7.1 The fundamental principles governing the investigation and prevention of civil aviation accidents and incidents in Europe are defined in the Regulation (EU) No 996/2010 on the investigation and prevention of accidents and incidents in civil aviation and repealing Directive 94/56/EC.
- 1.17.7.2 A safety recommendation is defined as a proposal from a safety investigation authority (SIA), based on information derived from a safety investigation or other sources such as safety studies, made with the intention of preventing accidents and incidents.
- 1.17.7.3 The Regulation (EU) No 996/2010 denotes appropriate authorities as recipients of safety recommendations. According to Article 17, safety recommendations can be given by a SIA at any stage of the investigation.
- 1.17.7.4 Each entity receiving a safety recommendation, including the authorities responsible for civil aviation safety at the Member State and Union level (EASA), shall implement procedures to monitor the progress of the action taken in response to the safety recommendations received.
- 1.17.7.5 The SIA should assess the safety recommendation responses in accordance with Article 18 of Regulation (EU) 996/2010. Where recommendations are ‘open’ or ‘closed’, this refers to whether a further response is expected from the addressee – it is not a reference to actions for a safety recommendation being complete or the safety issue being addressed. With reference to chapter 1.18.4, the AAIB assess the responses and classify them with one of the following:

1. **Adequate – Closed:** The response to the Safety Recommendation was deemed adequate and the recommendation has been closed.
2. **Partially Adequate – Open:** The response goes some way to addressing the intent and some action is taking place or is intended to take place for which further follow up is expected. As a result the recommendation remains Open.
3. **Partially Adequate – Closed:** The response goes some way to addressing the intent of the recommendation or safety issue. However, there is little or no likelihood of any further action by the addressee, so the recommendation is Closed.
4. **Not Adequate – Open:** The response does not address the intent of the Safety Recommendation and identified safety issue. However, the addressee is encouraged to review their response and further follow up is expected, therefore the recommendation remains Open.
5. **Not Adequate – Closed:** The response does not address the intent of the Safety Recommendation and identified safety issue. If it is unlikely that the addressee will carry out any further action, the Safety Recommendation is Closed.

## 1.18 Additional information

### 1.18.1 Safety actions following the accident with LN-OJF

#### 1.18.1.1 *29 April 2016: Grounding of EC 225 LP in Norway and UK*

Immediately after the accident, CAA Norway (Safety Directive 16/05616-1) and CAA UK (Safety Directive SD-2016/001) grounded Airbus Helicopters EC 225 LP helicopters. Search and Rescue (SAR) flights for the purpose of saving lives were exempted from this ban.

#### 1.18.1.2 *3 May 2016: EASA AD 2016-0089-E*

EASA issued Emergency Airworthiness Directive AD 2016-0089-E (1) to require, as a precautionary measure, the accomplishment of one-time inspections on EC 225 LP helicopters:

*Check the correct installation of the Front and Right Hand and Left Hand Rear MGB suspension bars in accordance with the instructions of Airbus Helicopters (AH) EC225 Alert Service Bulletin No. 53A058.*

AD 2016-0089-E also called for precautionary examination of the MGB magnetic chip detectors and the MGB oil filter to check for absence of metallic particles, as well as to download data and check for any threshold exceedance for helicopters equipped with M<sup>2</sup>ARMS Vibration Health Monitoring system.



### 1.18.1.3 11 May 2016: Grounding of AS 332 L2 in Norway and UK

CAA Norway (Safety Directive 16/05616-5) and CAA UK (Safety Directive SD-2016/002) extended the scope of the Safety Directives by also grounding Airbus Helicopters type AS 332 L2 helicopters, except SAR.

### 1.18.1.4 13 May 2016: AIBN first preliminary report

The AIBN published the first [preliminary report 13 May 2016](#), which gave a brief update on the progress and findings two weeks into the investigation, including a statement based on the CVFDR. Photos of some of the retrieved components were shown, including parts from the second stage planet gear and the fractured gear.

### 1.18.1.5 27 May 2016: AIBN second preliminary report

The AIBN published a second [preliminary report 27 May 2016](#), which stated that scenarios under consideration included failure of the epicyclic module, suspension bars (lift strut) and the MGB conical housing. In addition, the report noted that the BEA had succeeded in downloading FDM data that extended approximately 13 seconds beyond the CVFDR data presented in the 13 May report.

### 1.18.1.6 1 June 2016: AIBN third preliminary report with safety recommendation

The AIBN published a third [preliminary report 1 June 2016](#) with the following safety recommendation:

*Recent metallurgical findings have revealed features strongly consistent with fatigue in the outer race of a second stage planet gear in the epicyclic module of the MGB. It cannot be ruled out that this signifies a possible safety issue that can affect other MGBs of the same type. The nature of the catastrophic failure of the LN-OJF main rotor system indicates that the current means to detect a failure in advance are not effective.*

*The AIBN therefore recommends that EASA take immediate action to ensure the safety of the Airbus Helicopters H225 Main Gear Box.*

### 1.18.1.7 1 June 2016: EASA AD 2016-0103-E

Also on 1 June 2016, EASA issued superseding AD 2016-0103-E for further inspection and replacement instructions for correct installation of the MGB suspension bars and attachment fittings on EC 225 LP helicopters:

*The review of the data reported in accomplishing AD 2016-0089-E, revealed installation findings for the MGB upper deck fittings of the three MBG suspension bars, to include, among others, tightening torque values on the attachment bolts of the fittings being out of tolerance and some incorrect washers positioning in the fitting assemblies.*

*Prompted by these findings, Airbus Helicopters (AH) issued EC225 ASB No. 53A059 to provide further inspection and replacement instructions for correct installation of the MGB suspension bars and attachment fittings.*

*For the reason described above, this AD supersedes AD 2016-0089-E retaining its requirements and additionally requires, as a precautionary measure, to*

*perform other inspections and to replace the attachment hardware of all MGB suspension bar fittings and related base plate assemblies.*

*This AD is considered to be an interim action and further mandatory action may follow.*

#### 1.18.1.8 1-2 June 2016: CAA-N and CAA-UK grounded all operations

Based on the third preliminary report with safety recommendation, the CAA Norway (Safety Directive 16/05616-9) grounded all operations with EC 225 LP and AS 332 L2 helicopters. The CAA UK (Safety Directive SD-2016/003) also grounded all operations on 2 June 2016.

#### 1.18.1.9 2 June 2016: EASA flight prohibition

EASA issued AD 2016-0104-E on 2 June 2016 and temporarily grounded all civilian<sup>18</sup> EC 225 LP and AS 332 L2 helicopters:

*Soon after EASA AD 2016-0103-E was issued, a second preliminary report from the investigation board indicated metallurgical findings of fatigue and surface degradation in the outer race of a second stage planet gear of the MGB epi-cyclic module. At this time, it cannot be determined if this is a contributing causal factor or subsequent failure from another initiating factor.*

*Pending further investigation to determine the root cause(s) of the reported damage, and development of mitigating measures by Airbus Helicopters, EASA has decided, as an additional precautionary measure, to temporarily ground the fleet.*

#### 1.18.1.10 28 May 2016: AIBN forth preliminary report

The AIBN published a forth [preliminary report 28 June 2016](#). The report stated that:

*At this stage of the investigation, the AIBN finds that the accident most likely was the result of a fatigue fracture in one of the second stage planet gears. What initiated the fatigue fracture has not yet been determined.*

#### 1.18.1.11 June 2016: Airbus Helicopters military EASB

On 15 June Airbus Helicopters published Emergency Alert Service Bulletins (EASB<sup>19</sup>) addressing Time Limits and Maintenance Checks – Main Rotor Drive, applicable only to helicopters which are not subject to EASA Flight Prohibition in AD 2016-0104-E. These require, as precautionary measures, repetitive inspection of the MGB oil filter and chip detectors and removal of all MGB repaired following unusual events.

---

<sup>18</sup> The AD does not apply to EC 225 LP and AS 332 L2 helicopters while carrying out military, customs, police, search and rescue, firefighting, coastguard or similar activities or services, which remain under national legislation in the EASA Member States.

<sup>19</sup> Alert Service Bulletin Nos. ASB 05.01.07 (AS 332 L2), ASB 05.00.82 (AS 532), ASB 05A049 (EC 225 LP) and ASB 05A045 (EC 725).

On 29 June Airbus Helicopters issued EASB<sup>20</sup> addressing Main Rotor Drive – Epicyclic Module – Replacement of the epicyclic module second stage planet gears, applicable to helicopters which are not subject to EASA AD 2016-0104-E.

*As a precautionary measure, it was decided to maintain only one of the two types of epicyclic module second stage planet gears in service. This decision is based on the following observations on the planet gear type maintained in service:*

- The detailed design of the planet gear bearing has an increased damage tolerance.*
- Modeling and calculation reveal a lower load level on the external race of the planet gear bearing.*
- In-service experience shows enhanced reliability.*

*This ALERT SERVICE BULLETIN therefore requests that you identify the P/Nos. of the epicyclic module second stage planet gears and replace the module if its planet gears have the P/Nos. concerned.*

In effect, this meant replacement of FAG with SNR gears on all helicopters not subject to EASA AD 2016-0104-E.

#### 1.18.1.12 July - October 2016: Plan for Return to Service (RTS)

Following the grounding of the civilian EC 225 LP and AS 332 L2 helicopters on 2 June 2016, Airbus Helicopters and EASA started working towards a plan for Return to Service (RTS). During a progress meeting between EASA and Airbus Helicopters on 20 July 2016, the manufacturer presented a proposal of RTS based on two axis of action based on the two published military EASBs:

- 1. To prevent planet gear fatigue failure initiation.*
- 2. To enhance the planet gear spalling detection means.*

Several meetings between Airbus Helicopters and EASA took place in August and September which led to an agreement on a corrective actions package for RTS<sup>21</sup> (see Table 8). The corrective actions were developed by Airbus Helicopters in conjunction with EASA. The protective measures, as described in the table, aimed at reducing the probability of spalling (actions nos. 1, 2, 3) and increasing the probability of spalling/particle detection (actions nos. 4, 5, 6, 7, 8, 9).

---

<sup>20</sup> Alert Service Bulletin Nos. ASB 63.00.83 (AS 332 L2), ASB 63.00.38 (AS 532), ASB 63A030 (EC 225 LP) and ASB 63A029 (EC 725).

<sup>21</sup> See also text in chapter 1.18.1.14 regarding post-return to service Continuing Airworthiness Review Item (RTS CARI).

Table 8: Correction Actions Package for RTS. Source: EASA

No.	Area considered for action	Actions at the time of the LN-OJF accident	Corrective Action for RTS
1	Repaired MGB epicyclic modules subject to accidental events	N/A	Removal from service
2	Planet gear type	FAG and SNR	SNR only
3	MGB TBO and Planet Gear OTL	EC 225 LP: TBO 2000FH / OTL 4400FH	EC 225 LP: TBO 1500FH / SLL 1650FH
		AS 332 L2: TBO 3000FH / OTL 6600FH	AS 332 L2: TBO 2700FH / SLL 3000FH
4	Mast bearing, MGB epicyclic and sump chip detectors check	25FH (non-electrical) 50FH (electrical)	Daily / 10FH max
5	Oil cooler chip detector visual inspection	Not inspected (unless close monitoring <sup>22</sup> )	Daily / 10FH max
6	MGB oil filter visual inspection	Not inspected (unless close monitoring)	10FH
7	Cumulated spalling area for MGB removal	50 mm <sup>2</sup>	3 mm <sup>2</sup> of 16NCD13 (chips analysis before next flight) <sup>23</sup>
8	Maximum particle thickness for MGB removal	0.4 mm	0.2 mm
9	MGB chips burner use	RFM emergency procedures	No more in-flight use

#### 1.18.1.13 7 October 2016 – EASA lifted the flight prohibition

On 7 October 2016, EASA lifted AD 2016-0104-E and issued AD 2016-0199 which allowed AS 332 L2 and EC 225 LP helicopters to fly, based on the accomplishment of the actions specified in the related Airbus Helicopters service publications<sup>24</sup>, with restrictions for combinations of second stage epicyclic gears and a strict inspection regime. The following is quoted from AD 2016-0199:

*There are two configurations of planet gear within the current type design. In depth review of the design and service data showed that one configuration has higher operating stress levels that result in more frequent events of spalling, associated with rolling contact fatigue, while the other exhibits better reliability behaviour. By limiting the type design to the gear configuration with lower stress*

<sup>22</sup> Close monitoring: If particles are detected, but analyzed and found to be within defined limits, close monitoring of the MGB oil filter and chip detectors had to be performed the next 25 flight hrs.

<sup>23</sup> Note: This is a simplification of the actual maintenance requirement. Full instructions are given in the relevant Airbus Helicopters ASB as mentioned in footnote 21.

<sup>24</sup> Alert Service Bulletin Nos. ASB 63.00.83 (AS 332 L2), ASB 63A030 (EC 225), ASB 05.01.07 (AS 332 L2) and ASB 05A049 (EC 225 LP).

*levels and better reliability and specifying a reduced life limit, combined with more effective oil debris monitoring procedures and other operational controls, an acceptable level of safety can be restored.*

#### 1.18.1.14 Post-return to service Continuing Airworthiness Review Item (RTS CARI)

The post-return to service Continuing Airworthiness Review Item (RTS CARI) is an essential element of the EASA agreement for return to service. The CARI is a tool for EASA to control the TC holder analysis, test and investigation progress in an agreed timeframe. The CARI was raised on 6 October 2016 in conjunction with issuance of EASA AD 2016-0199. It consists of a batch of 17 post-RTS actions/items, see Table 9.

Table 9: CARI post-RTS actions/items. Source: EASA

No.	Item
1	OR spalling cases expertise
2	Lift bearing and mast splines reliability
3	“G-REDL test” additional analysis
4	Decision on ISIR SP1502 (M1018) planet gear (SNR planet gear with spalling on outer race)
5	Particles speed detection
6	“Aggressive” spalling (related to SNR planet gears)
7	Fatigue characteristics of shocked gears
8	New oil debris monitoring means
9	Design criteria
10	Service experience: feedback on post-RTS spalling instances
11	a) Further FAG gear test after impact damage. b) Further test of current oil debris monitoring
12	MGB lubrication
13	Application of EASA CM-S-007 Issue 01
14	DOA procedures for reliability analysis of critical parts
15	ICA and maintenance related actions
16	Post-RTS feedback on MGB in-service issues
17	Sub-surface cracking from spalling

#### 1.18.1.15 25 February 2017 – EASA AD 2017-0042

On 25 February 2017 EASA issued AD 2017-0042 requiring a one-time inspection of the oil cooler to acquire additional information on the condition of the MGB oil system<sup>25</sup>. The basis of this AD was Airbus Helicopters’ discovery of a particle recovered from the oil cooler in LN-OJF, which was identified by Airbus Helicopters as 16NCD13 spalling thus possible stemming from the fractured second stage planet gear (see chapter 1.16.8.3).

<sup>25</sup> Airbus Helicopters has issued EASB 05A049 Rev 3 (EC 225 LP) and 05.01.07 Rev 3 (AS 332 L2) in line with the AD 2017-0042.



#### 1.18.1.16 17 March 2017 – EASA AD 2017-0050-E

On 17 March 2017 EASA issued AD 2017-0050-E and introduces additionally periodical inspections of the oil cooler and some revision of other inspection intervals<sup>26</sup>.

#### 1.18.1.17 CAA-N and CAA-UK maintain grounding of all operations

At the time of completion of this preliminary report, the CAA-N and CAA-UK still maintain the flight prohibition of the helicopters.

#### 1.18.2 Accident to Aerospatiale SA330J, 9M-SSC, 16 December 1980<sup>27</sup>

1.18.2.1 On 16 December 1980, an Aerospatiale SA330J Puma helicopter, 9M-SSC, crashed in a swamp forest near Kuala Belait in the State of Brunei. The crew of two and all 10 passengers were fatally injured in the accident. The accident resulted from an MGB failure that had some similarities to that which occurred on LN-OJF and on G-REDL (see chapter 1.18.3). The MGB of the SA330J is fundamentally similar in layout to those of the AS 332 and the EC 225 series of helicopters, although the components are not interchangeable and the gear material specifications are different. The gearbox in the 9M-SSC accident had a recent history of quantities of metallic debris being found on the magnetic chip detector in the main module. The epicyclic module was not equipped with a chip detector.

1.18.2.2 The synopsis of the report on this accident contained the following:

*The accident occurred following the loss of the main rotor assembly, together with the attached bell housing containing the second stage gears of the epicyclic gearbox. Almost simultaneously, the entire tail boom section parted from the aircraft.*

*It is concluded that the most likely cause of the accident was a planetary gear failure in the second stage of the two stage epicyclic main gearbox reduction gear; the associated metal debris caused jamming within the rotating assemblies, generating forces which fractured the common epicyclic ring gear and the main gearbox casing. This resulted in the gross instability in the rotor system, which caused blades to strike the fuselage.*

*The initial cause of the accident was due to the mistaken health monitoring of the gearbox, leading to a deterioration of the mechanical condition of the gearbox components.*

1.18.2.3 The Findings in the report contained the following:

*2. Gross contamination of the main gearbox magnetic plug and filter had occurred during the six weeks preceding the accident. The particles had undoubtedly originated from the second stage planet pinion bearing surfaces. Maintenance personnel had wrongly interpreted the amount of allowable debris*

---

<sup>26</sup> Airbus Helicopters has issued EASB 05A049 Rev 4 (EC 225 LP) and 05.01.07 Rev 4 (AS 332 L2) in line with the AD 2017-0050-E.

<sup>27</sup> This description is copied from the AAIB UK Report on the accident to Aerospatiale (Airbus Helicopters) AS332 L2 Super Puma, registration G-REDL 11 nm NE of Peterhead, Scotland on 1 April 2009.

*as defined in the Aerospatiale Standard Practices Manual, due to the mistaken interpretation of an unfamiliar metric term.*

6. *Gross instability in the rotor system was caused by the jamming of the gearbox [epicyclic] reduction gear due to the disintegration of a pinion [planet] gear in the second stage of the reduction gear [epicyclic gearbox].*

1.18.2.4 The first of two causes stated in the report was as follows:

*The accident was caused by the disintegration of a secondary stage planet pinion [gear] within the gearbox following a seizure of its associated roller bearing.*

1.18.2.5 The break-up of the second stage planet gear in this accident was precipitated by a maintenance error which allowed a severely deteriorated gear to fail. No part of the failed gear was recovered and the entire first planetary stage was missing. However, the break-up of the gear resulted in circumferential failures of the ring gear casing, above and below the epicyclic stages, together with a vertical rupture.

1.18.2.6 In Appendix 1 to the report, the manufacturer made various comments negating the MGB bursting as the accident first cause, but has later concurred.

1.18.2.7 Gearbox health monitoring essentially consisted of daily checks of the magnetic plug, together with regular Spectrographic Oil Analysis Program (SOAP) samples. However, the manner in which the latter was conducted did not result in pertinent or timely information being presented to the operator.

1.18.2.8 A retrospective analysis of SOAP results, taken during the weeks that preceded the accident, was completed using processes then in use by the UK Royal Air Force. The results validated the SOAP process by demonstrating that timely indication of the deterioration of the MGB was possible.

1.18.3 Accident to Eurocopter AS 332 L2 G-REDL 11 nm NE of Peterhead, Scotland on 1 April 2009

1.18.3.1 On 1 April 2009, a Eurocopter AS 332 L2 Super Puma, G-REDL, crashed into the sea 11 nm NE of Peterhead, Scotland. The crew of two and all 14 passengers were fatally injured in the accident. Similar to LN-OJF, the helicopter was en route from a production platform, the Miller Platform, in the North Sea to Aberdeen. The accident resulted from an MGB failure, with many similarities to that which occurred on LN-OJF.

1.18.3.2 The synopsis of the report on this accident contained the following:

*An extensive and complex investigation revealed that the failure of the MGB initiated in one of the eight second stage planet gears in the epicyclic module. The planet gear had fractured as a result of a fatigue crack, the precise origin of which could not be determined. However, analysis indicated that this is likely to have occurred in the loaded area of the planet gear bearing outer race.*

1.18.3.3 In contrast to LN-OJF, there was one indication of the impending failure of the second stage planet gear. Some 36 hours prior to the accident, a metallic particle measuring 2.88 by 0.8 mm had been discovered on the epicyclic chip detector during maintenance. The particle had probably been released from a position approximately 14 mm from the edge

of the outer race of the failed gear. It was considered to have been released from a section of the failed gear which was not recovered following the accident.

- 1.18.3.4 The origin of the crack was in a section of the failed gear which was not recovered. Figure 62 shows a stress model prediction of crack growth as displayed in the G-REDL report. If a crack of sufficient depth, originating at or close to the race surface, were to exceed the depth of the carburized layer, the stress analysis identified the possibility of crack propagation, in a manner similar to that observed on the failed gear.

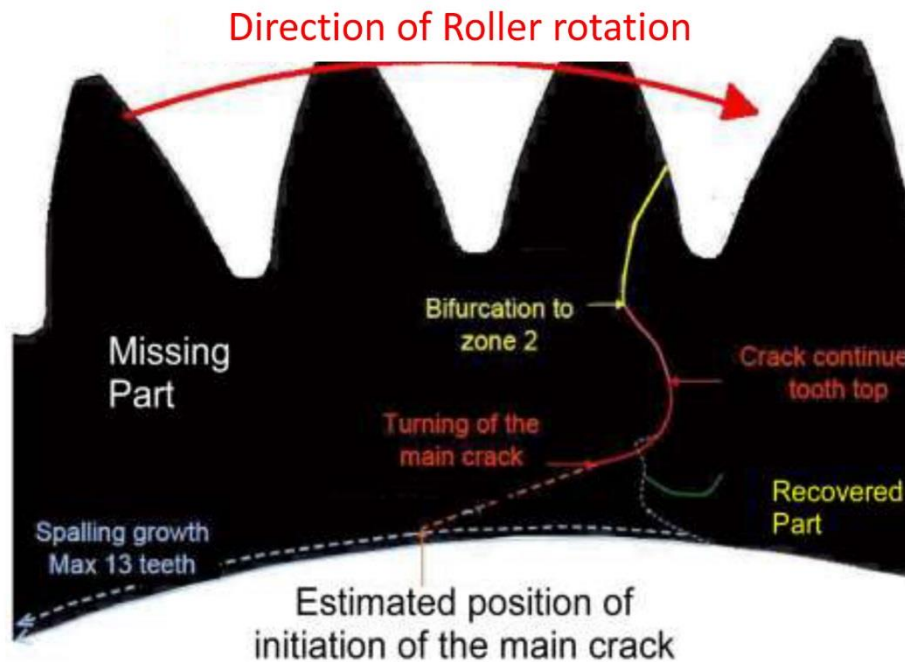

Figure 62: Stress model estimation of crack growth. Source: Airbus Helicopters

- 1.18.3.5 The following is quoted from page 89 in the G-REDL report concerning cracks formation beyond the carburized layer:

*An investigation of two planet gears which had been removed from other gearboxes, due to the presence of spalling, confirmed that cracks could form within the carburised layer of the gear. These two examples showed spalling around their circumference, but the cracks that had formed from these had progressed beyond the carburised layer. In contrast, due to the lack of damage to the recovered sections of G-REDL's failed gear, any spalling must have been restricted to a maximum of 25.5% of its circumference.*

- 1.18.3.6 The synopsis of the report also noted:

*The lack of damage on the recovered areas of the bearing outer race indicated that the initiation was not entirely consistent with the understood characteristics of spalling. The possibility of a material defect in the planet gear or damage due to the presence of foreign object debris could not be discounted.*

- 1.18.3.7 The investigation identified the following contributory factors:

1. The actions taken, following the discovery of a magnetic particle on the epicyclic module chip detector on 25 March 2009, 36 flying hours prior to the

*accident, resulted in the particle not being recognised as an indication of degradation of the second stage planet gear, which subsequently failed. [Maintenance failure/Human factors issue]*

2. *After 25 March 2009, the existing detection methods did not provide any further indication of the degradation of the second stage planet gear.*
3. *The ring of magnets installed on the AS332 L2 and EC225 main rotor gearboxes reduced the probability of detecting released debris from the epicyclic module. [On 18 April 2009 AH issued an EASB, which gave instructions for the removal of the ring of magnets on the gearbox oil separator plates.]*

#### 1.18.4 Safety recommendations and safety actions following G-REDL

1.18.4.1 The AAIB issued 17 safety recommendations during the course of the investigation. In particular, the following safety recommendations are relevant to the LN-OJF investigation (see chapter 1.17.7 for explanation of the AAIB assessment):

##### 1.18.4.2 *Safety recommendation 2011-032*

Safety recommendation 2011-032 advises Airbus Helicopters to introduce further means of identifying MGB degradation, such as debris analysis of the MGB oil. In the response Airbus Helicopters stated that magnetic plugs and/or chip detectors “*are sufficient to ensure flight safety*”. The understanding of the AIBN is that Airbus Helicopters based their response to this recommendation on three arguments:

- One particle was discovered prior to the G-REDL accident that according to the maintenance procedure, should have led to the removal of the MGB.
- The particle detection capability of the sump and epicyclic chip detectors had been enhanced by the removal of the ring of magnets from the lower area of the epicyclic module.
- SOAP is not effective for spalling detection, it had previously led to many removals of gear boxes which revealed no bearing damage, and thus was removed as a requirement in 1986.

The AAIB assessment was stated as “Not Adequate – Closed” because Airbus Helicopters did not introduce further means for detection.

##### 1.18.4.3 *Safety recommendations 2011-033, 2011-034 and 2011-035*

Safety recommendations 2011-033, 2011-034 and 2011-035 call for the evaluation of defective parts to ensure that they satisfy the continued airworthiness requirements. The investigation found that the manufacturer did not routinely examine planet gears that had been rejected due to spalling (see also section 1.6.11.3).

Following the safety recommendations, Airbus Helicopter’s Continued Airworthiness Process was explained again to, and considered by, EASA and subsequently validated. Furthermore, Airbus Helicopters stated that “*the Continuing Airworthiness process currently in place provides sufficient assurance and warranty that components critical to the integrity of all helicopter transmission which are found to be beyond serviceable*

*limits are examined so that the full nature of any defect is understood*". In April 2010 EASA carried out an audit of Airbus Helicopters on the DOA side and "*confirmed that the manufacturer was able to demonstrate that its procedures for compliance with the requirements of Part 21.A.3 are comprehensive and appropriately used*". The AAIB assessment of all three safety recommendations was "Adequate – Closed".

The AIBN has recently received the Finding and Action Record from the EASA audit reports following DOA inspections of Airbus Helicopters in the period 2009 – 2016. At the time of publication of this preliminary report the AIBN has not yet studied this documentation.

#### 1.18.4.4 *Safety recommendation 2011-036*

Safety recommendation 2011-036 advises EASA to re-evaluate the continued airworthiness of the MGB to ensure that it satisfies the current certification requirements and EASA NPA 2010-06 (see chapter 1.17.6.3). EASA based their re-evaluation mainly on removing the ring of magnets from the lower area of the epicyclic module.

EASA requested Airbus Helicopters to complete their current fatigue justification file of the Main Rotor Gearbox (MGB). EASA also requested that Airbus Helicopters provide a complementary assessment aiming to take into consideration MGB fatigue tolerance evaluation. Furthermore, Airbus Helicopters had launched a test program for MGB actual spalling testing (see chapter 1.6.9), which was followed by EASA. This test program had just been completed at the time of the LN-OJF accident, but the results were under discussion.

In addition to the above activities, EASA considered that the safety of the fleet relied primarily on the magnetic plugs to ensure early detection of spalling. In order to increase the likelihood of detecting any particles, EASA issued AD 2012-0129-E on 23 July 2012 mandated to standardize intervals of the visual checks of all electrical and non-electrical chip detectors, and to require this check for all models of the Super Puma family. This action was accomplished on all rotor drive system gear boxes, i.e. on the MGB and also on the Intermediate Gear Box (IGB) and the Tail Gear Box (TGB).

The AAIB assessment of EASA's response to the safety recommendation and the intended test program outlined by Airbus Helicopters was "Adequate – Closed".

The AIBN has recently received the documentation related to the re-evaluation of the continued airworthiness of the MGB from EASA. At the time of publication of this preliminary report the AIBN has not yet studied this documentation.

#### 1.18.4.5 *Safety recommendation 2011-041*

Safety recommendation 2011-041 advises EASA to research methods for improving detection. As a result, EASA launched a VHM research project at Cranfield University (see description in chapter 1.11.2.6). The report was finalized in June 2015. Cranfield concluded that the current VHM system is unable to detect a degradation in the epicyclic module, but alternative detection methods could be feasible and recommended this further examined. The AAIB assessment of the intended research project outlined by EASA in their response to the safety recommendation was "Adequate – Closed".



#### 1.18.4.6 *Safety recommendations 2011-045 and 2011-046*

Safety recommendations 2011-045 and 2011-046 recommend EASA and the FAA to require modifications to ‘crash sensor’ in helicopters, fitted to stop a Cockpit Voice Recorder in the event of an accident (see also description in chapter 1.11.1.4). The AAIB assessment was respectively “Partially Adequate – Open” and “Not Adequate – Open”.

#### 1.18.4.7 *Additional comments from Airbus Helicopters*

According to Airbus Helicopter they did not perform a root cause analysis for the G-REDL accident. The reason was that the investigation confirmed that the particle collected 36 flight hours prior to the accident was a scale originated from the loaded area of the failed planet gear outer race and that the associated inner race evidenced significant density of dents/impacts from particles (similar to what the manufacturer used to find when a planet gear spalling is observed).

According to Airbus Helicopters, such observations clearly identified that the root cause of the G-REDL event was the failure of the second stage outer race resulting from a progressive spalling whose particles detection had been limited due to the presence of magnets, and the non-opening of the epicyclic module to inspect and collect particles on these magnets as requested through the in place documentation. Soon after these first findings Airbus Helicopters issued an EASB to mandate the removal of the magnets.

In addition, the lack of the assumed spalled area (not recovered) did not permit a full investigation into the initiation, but some analysis (finite elements calculation) had been performed to explain the shape of the fracture surface (sea shell shape) which is obtained when the crack reaches a defined depth.

Airbus Helicopters has stated to the AIBN that the removal of the magnets (around 85% of the particles were collected by the magnets), the modification of the maintenance program, removal criteria concerning the particles and the Service Letter to detail the different types of particles were considered as sufficient and appropriate to restore the airworthiness of the fleet. According to Airbus Helicopters, this was supported by the in-service experience following the G-REDL accident, until the LN-OJF accident, showing that spalling of epicyclic modules are discovered significantly sooner without the magnets.

#### 1.18.5 The accidents to Eurocopter EC 225 LP Super Puma G-REDW 34 nm east of Aberdeen, Scotland on 10 May 2012 and G-CHCN 32 nm southwest of Sumburgh, Shetland Islands on 22 October 2012

1.18.5.1 The AAIB published a combined report into the two Airbus Helicopters EC 225 LP successful ditchings in the North Sea in 2012. Both helicopters experienced a loss of main rotor gearbox oil pressure due to a failure of the bevel gear vertical shaft in the main rotor gearbox, which drives the oil pumps. The shafts had failed as a result of a circumferential high-cycle fatigue crack. The stress, in the area where the cracks initiated, was found to be higher than that predicted during the certification of the shaft.

1.18.5.2 These accidents were not similar to the LN-OJF accident. Nevertheless, these ditchings led to the restricted operation of the EC 225 LP fleet in 2012. The helicopter manufacturer carried out several safety actions and redesigned the bevel gear vertical shaft as a result of these accidents.

### 1.18.6 Certification documentation

- 1.18.6.1 The AIBN made a formal request to EASA for 19 documents regarding the certification of the AS 332 L2 and EC 225 LP. The AIBN has received the documents referred to as Certification Review Item (CRI). However, most of the documents are the property of Airbus Helicopters. It follows from the record keeping requirements of Annex I (Part 21) to Commission Regulation (EU) No 748/2012 that all relevant design information shall be held by the type certificate holder (TCH).
- 1.18.6.2 Subsequently, the AIBN has requested Airbus Helicopters for the remaining documents. However, due to internal Airbus Helicopters' policy, these proprietary documents cannot be released to the AIBN, but the AIBN has been offered to study the documents at site. The AIBN has received the front page of all the documents that were requested from Airbus Helicopters.
- 1.18.6.3 At the time of publication of this preliminary report the AIBN has not yet studied this documentation.

### 1.19 **Useful or effective investigation techniques**

#### 1.19.1 Underwater search for parts using magnets

- 1.19.1.1 During the early search phase, Miko Marine AS was contacted by the AIBN and asked if they could provide a device that could pick up magnetic parts from the sea bed with magnets. The company produced a sledge with magnets intended to be towed along the seabed (see Figure 63). The sledge was 200 cm long, 100 cm wide and 50 cm high. It was designed from aluminum and weighed 150 kg. The sledge had three rows of strong magnets (14 all together) installed on flexible supports and each with a capacity of lifting 500 kg. The sledge was equipped with buoyancy measures making it easy to operate sub-sea, and two video cameras for operations monitoring.
- 1.19.1.2 The sledge, which was a prototype built for the AIBN in only a few days, was hired for about two weeks. It was towed behind a 15-metre long vessel with a 450 bhp engine and a bow thruster.
- 1.19.1.3 The sledge was most effective in picking magnetic parts from flat seabed. The magnets could find and hold even small fragments that otherwise would have been almost impossible to find by other means. It could find small parts imbedded in mud or sand. The forward looking video camera was useful in mapping the area directly in front of the sledge. This was beneficial in areas where it was possible to see the traces of the previous search line and thus make it possible to adjust course to prevent gaps or unnecessary overlap. The camera could also detect bigger parts on the seabed at a wider area than the sledge.
- 1.19.1.4 The main challenge was to follow a defined search line on anything but even flat seabed. The width of the sledge limited the progress if 100 % coverage was to be achieved. Heavy sea weed growth did also cause trouble as it accumulated on the sledge and caused the magnets to bend.
- 1.19.1.5 The magnetic sledge found pieces like fragments from epicyclic gear inner races and rollers from epicyclic gear bearings.



*Figure 63: The magnetic sledge being retracted from the sea. Photo: AIBN*

#### 1.19.2 X-ray computed tomography scan (CT-scan)

CT-scans were used to determine and map possible sub-surface material abnormalities, and they have been used in several air safety investigations. The AIBN would like to emphasize the importance of avoiding damaging important evidence by premature cuts made to the parts being examined. During this investigation the knowledge and equipment present at Southampton University, UK was used to map cracks in the second stage planet gear and to develop the plan to cut the gear parts.

## **2. COMMENTS FROM THE ACCIDENT INVESTIGATION BOARD NORWAY**

### **2.1 Introduction**

- 2.1.1 Based on evidence from the helicopter wreckage, recorded flight data and extensive metallurgical examinations the AIBN has been able to reconstruct the in-flight break-up of the main rotor gear box and the subsequent detachment of the main rotor. Furthermore, to determine that the accident was a result of failure of the main rotor gearbox (MGB) due to a fatigue fracture in one of the eight second stage planet gears in the epicyclic module.
- 2.1.2 In these comments, the AIBN will clarify the accident sequence, summarize some of the technical investigations and assess the safety barriers that existed to prevent the accident. Further, the AIBN will briefly discuss the similarities with the G-REDL accident off the coast of Scotland in 2009 and the follow-up of the safety recommendations resulting from the investigation done by the AAIB. Finally, the AIBN will point to further investigation steps.

### **2.2 The accident sequence**

- 2.2.1 All aspects of the accident flight is considered as normal until the main rotor separated. The helicopter had just descended from 3,000 ft and had been established in cruise at 2,000 ft for about two minutes when the second stage planet gear failed. No warnings were given to the crew before mechanical noise was recorded by the CVFDR immediately before the main rotor detached from the helicopter.
- 2.2.2 The gear mesh became disrupted when the fatigue crack grew large enough to split one of the second stage planet gears. Teeth colliding caused an abrupt seizure of the gearbox. Torque from the engines via the main module and inertia from the main rotor started to break the gearbox apart. Several of the 17 bolts at the flexible mounting plate aft attachment showed clear signs of being sheared by a force acting towards the left. This is consistent with an immediate jamming of the gearbox at the same time as main rotor inertia torque forces are exerted.
- 2.2.3 The jamming of the second stage epicyclic gear caused a rupture of the epicyclic ring gear and a break-up of the conical housing. This in turn disrupted the power transmission chain from the engines to the main rotor, and led to a large decrease in engine torque demand. A torque peak caused by the jamming was not recorded and this indicates that the duration was shorter than the FDR and PCMCIA sampling rate. The torque reduction is defined as T0 in this investigation.
- 2.2.4 The opening of the ring gear and the break-up of the conical housing caused loss of structural integrity in the upper section of the gearbox. The upper part of the conical housing, including the main rotor mast, became disconnected from the main module and allowed independent movement. The flight control servos are connected to the main module, and any relative movement between the rotor and the main module will cause erratic flight control inputs to the main rotor. The main rotor was at that point still attached to the helicopter via the three suspension bars.

- 2.2.5 Transferring torque from the MGB to the helicopter structure is the main function of the flexible mounting plate which is bolted to the bottom of the main module. In addition to the suspension bars, which take the lift loads from the rotor, the rotor stability is dependent on the integrity of the flexible mounting plate and the MGB structure.
- 2.2.6 The loss of MGB structural integrity and the erratic flight control input initiated by the same loss of structural integrity, caused an uncontrolled forceful movement of the main rotor. This ultimately pulled apart all three suspension bars and allowed the main rotor to separate from the helicopter. It is likely that the rotor at one point tilted aft during this period, contacting and scratching the tail rotor shaft tunnel. It is also likely that the rotor at some stage tilted significantly forward and hit one of the engine air inlet screens, causing it to fly away and land on the island Litlaskora north of the flight track.
- 2.2.7 The erratic forceful movement of the main rotor and the overload of the suspension bars most likely caused heavy vibrations in the transmission deck which exceeded 6 G, the value set for the CVFDR g-switch, causing the CVFDR to stop at T+1.5. The PCMCIA card continued to record another 12.65 sec. This indicates that the helicopter continued for at least 13 seconds before it hit the small island Storeskitholmen after detachment of the main rotor.
- 2.2.8 A consequence of the epicyclic gear failure was that the load from the main rotor on the engines suddenly disappeared. This caused an initial overspeed of the power turbines (N2) and following this, a significant reduction in gas generator speed to about 70 % N1. Information recorded on the PCMCIA card indicates that the helicopter climbed a few seconds, but started to fall after the peak was reached at T+5.5. No parameters recorded exactly at what time the main rotor separated, but the rotor speed data indicates that the rotor speed decreased towards 0 % at T+4. The PCMCIA data and the engine examination confirm that the engines were running continuously until the helicopter hit the island. During this period the engines continued to drive the MGB main module and the tail rotor. This can explain why the tail rotor had damages to all blades and showed clear evidence of being powered during impact.
- 2.2.9 The location of wreckage parts indicates that a number of parts, other than the main rotor, fell off the helicopter before it hit the island. An example was the aft MGB cowling (dog house) which was probably knocked off early in the break-up sequence due to the excessive movement of the main rotor.
- 2.2.10 Several witnesses saw flames emitting from the transmission deck area before the helicopter hit the island. The on-board fuel evaporated and exploded during impact with the island and the ensuing fire caused marks of burns and soot on the wreckage even though it went straight into the sea. This made it difficult to distinguish traces of burns originating from fire before or after the impact. However, a potential ignition source may have been high temperatures related to the MGB break-up sequence, and the flames observed in the air may have been the MGB oil bursting in flames.
- 2.2.11 All 13 persons on board perished instantly when the helicopter hit the island. Although several emergency service units were at the site within a short time, any lifesaving activity was futile.



## 2.3 Technical investigation

### 2.3.1 Introduction

2.3.1.1 Initially, the investigation team focused on all aspects that could possibly lead to a separation of the main rotor and rotor mast. Three possible scenarios were identified as plausible initiating events; failure of the epicyclic module, the suspension bar attachments or the conical housing. Already in the first week following the accident the AIBN informed the team about one planet gear fracture surface of particular interest. In the preliminary report on 13 May 2016, 15 days after the accident, the AIBN published a photo showing parts from the fractured second stage planet gear. Subsequent detailed metallurgical examinations confirmed that the gear had fractured due to fatigue. The through-thickness fracture shows clear similarities with the estimated crack growth in the missing half of the G-REDL gear (see Figure 62).

2.3.1.2 Detailed examination ruled out the conical housing and the suspension bar attachments as initiating events:

- The conical housing was intact when the ring gear opened. This is supported by 1) witness marks, and 2) elongation of all holes on top of the conical housing in the same circumferential direction, suggesting the top of the conical housing was forced against the lift housing in the direction of the rotating main rotor. Similar indications of elongated holes can be observed on both the ring gear flange and the mating conical housing flange. Additional break-up of conical housing was most probably caused by a combination of the movement of the rotor mast and rotating gear components.
- Examinations of the suspension bars and fittings showed that they had been installed properly and failed due to overload. This is consistent with them being intact at the moment of break-up of the epicyclic module.

2.3.1.3 In the continuation, the AIBN has focused on investigating the characteristics, initiation and development of the fatigue in the second stage planet gear.

### 2.3.2 The fatigue fracture

2.3.2.1 Growth of a fatigue crack requires repeated load cycles. The fatigue had its origin in the surface of the upper outer gear race of the planet gear. It started at the surface and propagated sub-surface with a shallow angle into the bulk material, turning towards the web of the gear teeth and the final through-thickness fracture.

2.3.2.2 The metallurgical examinations have given a reasonable, but not full, understanding of how the cracks evolved and finally how they ended in a rupture of one of the second stage planet gears. The fatigue cracks appear to have initiated from a surface micro-pit. The cause for the formation of the micro-pit has not been established. It has furthermore not been possible to get a comprehensive understanding of the different phases of the crack propagation.

2.3.2.3 The AIBN is of the opinion that it has been impossible to conclude on the propagation time from initiation to final through-thickness fracture based on the fractography (see chapter 1.16.3.6 and 1.16.3.16).

- 2.3.2.4 In front of the through-thickness fracture, centred around the 14 mm line from the upper edge of the gear, there are four spalls in the race of the gear. These are named spall one through four and are increasingly larger in both depth and size from one to four. Spall one, two and three have similar appearance; V-shaped and with edges showing evidence of flaking. Indents between the spalls indicate release of debris while the spalls were growing. The steeper and deeper-sided spall four appears to have released material in one piece and most probably during final break-up. The AIBN is of the opinion that the fatigue cracks grew in the direction from spall one to spall four regardless of spall two and three. Airbus Helicopters does not support this view.
- 2.3.2.5 Examination showed numerous micro-pits in the outer bearing surface in the band located of approximately 14 to 16 mm from the outer upper edge of the gear and with a centre at the 15 mm line (see section 1.16.3.23). Small cracks emerge from these at an angle into the material seen in roller direction (towards the through-thickness final fracture).
- 2.3.2.6 The preliminary understanding is that there were at least three different phases of the crack propagation:
- Phase one was the initiation of a micro-pit and through the hardened part of the carburized layer which has the highest residual compressive stress.
  - The second phase was the growth through the remaining carburized layer towards the bulk material in the roller direction.
  - The third phase was the propagation into the bulk material towards final fracture.
- 2.3.2.7 The driving force was probably not the same in these different phases. The cracks are predominately inter-granular in the carburized layer and becomes increasingly trans-granular as the crack gets deeper.
- 2.3.2.8 Observation on the LN-OJF crack propagation shows that the sub-surface cracks branch in different directions. Some of the cracks which deviate towards the race surface appear to stop before they reach the surface and thus do not release metallic particles (spalls). The investigation is looking at the possible relation between this phenomena and the progressively higher compressive stress in the area where the cracks stop.
- 2.3.3 Influential factors
- 2.3.3.1 There have been no findings to suggest that this fatigue crack propagated as a consequence of a structural break-up of another component. No material conformity issues have been revealed during the investigation. All measurements are to specification or apparently typical.
- 2.3.3.2 How the failure could develop and grow with limited spalling is currently not fully understood.
- 2.3.3.3 The investigation has revealed there is a difference in contact pattern on the outer race between planet gears from different vendors (SNR and FAG) (see chapter 1.6.8.3). Both the fractured second stage planet gear from the G-REDL helicopter and the gear from LN-OJF were supplied by FAG. Based on the present available information and as long as the reason for formation of the micro-pit and the underlying driving mechanisms are not yet fully understood, the AIBN has not been able to conclude with regard to a

possible connection between the fatigue and the differences in design, including both contact pressure and compressive residual stress. The CARI post-RTS process (see Table 9 in chapter 1.18.1.14) has also initiated relevant actions.

2.3.3.4 Numerous micro-pits in the outer bearing surface with a centre at the 15 mm line were observed (ref. section 2.3.2.5). Small cracks emerge from these at an angle into the material seen in roller direction. The G-REDL report could not discount *“the possibility of a material defect in the planet gear or damage due to the presence of foreign object debris”* (ref. section 1.18.3.6). The AIBN is investigating further into the possibility of foreign object debris (FOD) as an influential factor for initiation of the fatigue fracture.

2.3.3.5 A possible misalignment of the rotor mast has been raised as an issue during the investigation. The AIBN has examined the spline on the rotor shaft and found no abnormalities. Preliminary examination of the inner race on the planet carrier has revealed no major surface errors possibly being a result of damaged rollers. These examinations, in combination with the HUMS-data showing no vibrations originating from this area, indicate that any abnormal loads due to misalignment is unlikely.

#### 2.3.4 The ground transport accident to the MGB

2.3.4.1 The gearbox had been involved in a road accident during transport in 2015 (see chapter 1.6.10.4). The gearbox was inspected, repaired, given an EASA Form 1 and released for flight by the manufacturer before it was installed on LN-OJF in January 2016.

2.3.4.2 The AIBN has assessed the characteristics of the road accident damage with a view to identify any link between this event and the initiation and growth of fatigue cracks in the second stage planet gear. There were not observed any surface indents possibly stemming from the ground transport accident in the vicinity of the fracture initiation. Residual stress measurements on the outer race surface were performed at Airbus Helicopters and were found to be typical of a FAG manufactured bearing. Based on this, the AIBN has found no physical evidence that could connect the ground transport accident to the subsequent initiation and growth of the fatigue cracks. Airbus Helicopters is of the opinion that shock could be a contributing factor to the LN-OJF accident, but is not the single root cause.

## 2.4 **Safety barriers**

2.4.1 An essential design philosophy is that a crack in the surface area should grow outward and create debris (spalling), which could be detected on the magnetic plugs (chip detection system, see 1.6.9). A visual warning to the flight crew is provided when one particle of sufficient size or a sufficient cumulative quantity of particles, bridge the axial gap of the magnetic plug.

2.4.2 No findings indicate any malfunctions to the chip detection system on LN-OJF, or fail to follow procedures for inspection and checks before flight. Neither are there any records of magnetic debris findings from inspections made since the gearbox was installed on LN-OJF in January 2016.

2.4.3 No chip warning was given to the flight crew before the MGB failure. The MGB chip detectors were inspected with no findings 15:22 flight hours prior to the accident.

2.4.4 Spall 1, 2 and 3 have in total released a maximum of 28 mm<sup>2</sup> of metal particles prior to the accident. Furthermore, it is unknown at what time these particles were released, and

also their size. Bridging the axial gap (2.28 mm) of the magnetic plug requires a substantial amount of small particles or one or more large particles. Evidence indicate that spall 4 was released during the break-up phase.

- 2.4.5 At the time of the LN-OJF accident, the criteria for MGB removal was 50 mm<sup>2</sup> of metal particles or a 0.4 mm particle thickness or a 2 mm length particle or a 2 mm<sup>2</sup> surface particle of dedicated material. The MGB spalling test, which Airbus Helicopter launched after the G-REDL accident, has shown that the total detection rate for the magnetic plugs is 12 % (see Figure 12). In other words; in relation to the total area of maximum 28 mm<sup>2</sup> released from spall 1-3, approximately 3.3 mm<sup>2</sup> would be the potential detectable amount, which is far below the limit of 50 mm<sup>2</sup> for MGB removal at the time. This is on the condition that particles were smaller than a 0.4 mm thickness or a 2 mm length or a 2 mm<sup>2</sup> surface. The process of identifying particles also relies on human performance and interpretation, which turned out to be challenging in connection with the G-REDL accident (see section 1.18.3.7).
- 2.4.6 Vibration monitoring (VHM / HUMS, see 1.11.2) is a potential additional means for detecting developing degradation, and is mandatory for offshore operations in the North Sea. However, this system was not mandatory for establishing instructions for continued airworthiness at certification and has not proven to be effective in monitoring epicyclic module planet gear bearings. The analysis of the HUMS data for LN-OJF does not show evidence of trends or abnormal vibration behavior for any dynamic parts monitored by the system. Thus, the HUMS was unable to detect the fatigue fracture propagating in the second stage planet gear.
- 2.4.7 The observed failure mode, i.e. crack initiation and propagation with limited spalling, in this accident seems to differ from what was expected or foreseen during the design and certification of this helicopter type. The fracture propagated in a manner which was unlikely to be detected by the maintenance procedures and the monitoring systems fitted to LN-OJF at the time of the accident intended for warning of an imminent failure.

## 2.5 The G-REDL accident

- 2.5.1 The LN-OJF accident has clear similarities to the G-REDL accident off the coast of Scotland in 2009. G-REDL had a near identical main rotor gearbox as the one installed in LN-OJF. In both accidents, one of the eight second stage planet gears in the epicyclic module fractured as a result of fatigue.
- 2.5.2 For G-REDL, the origin of the crack was in a section of the failed gear which was not recovered, and consequently the precise origin and nature of the fracture could not be determined. For LN-OJF, the parts of the planet gear in which the fracture initiated was recovered. The G-REDL report displayed a stress model prediction of crack growth in the section of the planet gear which was not recovered (see Figure 62). The crack propagation underneath the depth of the carburized layer in the retrieved second stage planet gear from the LN-OJF accident (see Figure 42) appears to be very similar to the G-REDL stress model prediction of crack growth.
- 2.5.3 In contrast to LN-OJF, there was indication of the impending failure of the second stage planet gear in G-REDL. Some 36 hours prior to the accident, a metallic particle had been discovered on the epicyclic chip detector during maintenance. Unfortunately, the actions taken resulted in the particle not being recognized as an indication of degradation of the

second stage planet gear, which subsequently failed. After this single chip detection, the existing detection methods did not provide any further indication of the degradation of the second stage planet gear. The AAIB investigation also concluded that the ring of magnets installed on the AS 332 L2 and EC 225 LP main rotor gearboxes at the time, probably trapped released debris from the epicyclic module and reduced the probability of detection.

- 2.5.4 Safety recommendations are proposals based on lessons learned from accident and incident investigations, with the objective of preventing recurrences<sup>28</sup>. Due to the similarities of the two accidents, this investigation also focuses on the follow-up of the safety recommendations issued by the AAIB in connection with the G-REDL report, as well as the continuing airworthiness of the gearbox after 2009.
- 2.5.5 The AIBN is aware that one should be careful to pass a critical judgement of the adequacy of the actions taken following the G-REDL accident, based on the hindsight created by the knowledge we have after LN-OJF. The actions made by the manufacturer and the authorities in the aftermath of G-REDL were based on the available knowledge and circumstances at the time. This knowledge was naturally limited for several reasons; most importantly, key elements of information were missing due to the fact that not all gear parts were recovered.
- 2.5.6 It is, however, the mandate of the safety investigation authority to assess how and why two similar catastrophic accidents could happen only seven years apart to near identical helicopters.
- 2.5.7 In particular, safety recommendation 2011-036 from the G-REDL investigation advises EASA to re-evaluate the continued airworthiness of the MGB to ensure that it satisfies the latest certification requirements. The AIBN regards this as the most important recommendation from G-REDL. EASA based their re-evaluation mainly on removing the ring of magnets from the lower area of the epicyclic module (see also additional comments from Airbus Helicopters in chapter 1.18.4.7). The re-evaluation done by EASA in conjunction with Airbus Helicopter did not lead to any additional changes in design, operational life limits or inspection process of the planet gears. As far as the AIBN has ascertained the performance differences between gears from different vendors were not an issue following the G-REDL accident.
- 2.5.8 The issue of detection was also discussed in connection with the G-REDL accident, and measures were taken to improve the detection of spalling; i.e. removing the ring of magnets and improved inspection regime. Safety recommendation 2011-032 advises Airbus Helicopter to introduce further means of identifying MGB degradation, such as debris analysis of the MGB oil. The accident with LN-OJF contradicts the response to the recommendation given by Airbus Helicopter stating that magnetic plugs and/or chip detectors “*are sufficient to ensure flight safety*”. In addition, EASA’s response to safety recommendation 2011-036 that “*the safety of the fleet relies primarily on the capability of the MGB magnetic plugs to ensure early detection of spalling*” (see chapter 1.18.4.4) was based on Airbus Helicopters’ in-service experience. Furthermore, the G-REDL spalling test program (detection rate of 12 %, see chapter 1.6.9) showed, according to Airbus Helicopters, that the chip detection system was sufficient to detect classical

---

<sup>28</sup> Irgens, Edith (2010): *Accident prevention through safety recommendations – How could the safety effect from AIBN’s investigations be improved?* Submitted as part of the requirement for the award of MSc in Air Safety Management at City University London.



spalling. For LN-OJF, the fact that the MGB degradation went on undetected by the chip detection system cannot be explained by the ring of magnets or by human factors/maintenance failure, as was the case with G-REDL.

- 2.5.8.1 A more detailed assessment of the actions in response to the safety recommendations, and how they were documented and closed by EASA and Airbus Helicopters will follow in the final report.

### 3. FURTHER INVESTIGATION

3.1 The main areas for the AIBN's further investigation are:

- The AIBN will continue with the metallurgical examinations and, in conjunction with Airbus Helicopters, as far as practicable seek to understand the underlying driving mechanisms of the fatigue fracture. This includes:
  - assessment of a possible connection between the fatigue and the differences in the two planet gear configurations approved for the gearbox.
  - detailed examination of the area where the fatigue crack is assumed to have initiated.
  - examination of the recently salvaged second stage planet carrier with the inner race from the fractured planet gear and the lower rotor mast bearing.
- The observed failure mode in this accident seems to differ from what was expected or foreseen during the design and certification of the main rotor gearbox. The certification process and Certification Specifications for Large Rotorcraft related to catastrophic failure and requirements for safety barriers will be subject to further investigation.
- The AIBN will continue the investigation into how and why two similar catastrophic accidents could happen to near identical helicopters only seven years apart. Further assessment of the follow-up on the G-REDL safety recommendations and the continuing airworthiness of the gearbox after 2009 is a relevant issue.

This work requires good collaboration with the responsible entities, primarily the helicopter manufacturer and the EASA, and unhampered access to relevant documentation.

3.2 Due to the scope and complexity of the investigation it is not feasible to estimate a completion date for the final report. The investigation will continue at a high activity level. Aviation authorities in Norway and Europe will be continuously updated on the investigation and its findings.

3.3 Finally, the AIBN emphasizes that decisions concerning the fleet airworthiness are not within the mandate of the safety investigation authorities. This is the responsibility of the regulatory authorities.

Accident Investigation Board Norway

Lillestrøm, 28 April 2017

## ABBREVIATIONS

AAIB	Air Accidents Investigation Branch / den engelske havarikommisjonen
A/C	Aircraft / luftfartøy
AD	Airworthiness Directive / luftdyktighetspåbud
AIBN	Accident Investigation Board Norway / SHT
AMP	Aircraft Maintenance Program / vedlikeholdsprogram
BEA	Bureau d'Enquêtes et d'Analyses pour la Sécurité de l'Aviation Civile / den franske havarikommisjonen
CAA	Civil Aviation Authority
CAM	Cockpit Area Microphone / mikrofon i cockpit
CARI	Continuing Airworthiness Review Item
CRI	Certification Review Item
CS	Certification Specifications / sertifiseringskriterier
CVFDR	Combined Voice and Flight Data Recorder / kombinert tale og ferdskriver
CVR	Cockpit Voice Recorder / taleregistrator
CWL	Cowling / deksel
DME	Distanse Measuring Equipment / avstandsmålerutstyr
DVOR	Doppler VHF Omnidirectional Radio range
EASA	European Aviation Safety Agency / den felleseuropeiske luftfartsmyndigheten
EASB	Emergency Alert Service Bulletin / hastemelding vedrørende sikkerhet gitt av fabrikant
EDS	Energy Dispersive X-Ray Spectrometer
ENBR	Bergen lufthavn Flesland
ENG C	Gullfaks C plattform
ENQ B	Gullfaks B plattform
FAA	Federal Aviation Administration / luftfartsmyndigheten i USA
FDM	Flight Data Monitoring
FDR	Flight Data Recorder / ferdskriver
FOD	Foreign Object Debris
Ft	foot (feet) – fot – (0,305 m)
ft/m	ft per minute
GNSS	Global navigation satellite system
GS	Glideslope / glidebane
H	Helicopter
hPa	hectopascal
HUMS	Health and Usage Monitoring System / system for tilstandsovervåking
ICAO	International Civil Aviation Organization / FN organ for sivil luftfart
ILS	Instrument Landing System / instrumentlandingsystem
IR	Instrument Rating / instrumentflygingsbevis
IR	Inner Race
kt	knot(s) – nautical mile(s) (1 852 m) per hour / knop
L/H	Left Hand / venstre
LOC	Localizer / retningsender
ME	Multi Engine / flermotors
METAR	METEorological Aerodrome Report / rutinemessig værobservasjon
MFDAU	Miscellaneous Flight Data Acquisition Unit
MHz	MegaHerz
MMA	Airbus Helicopters abbreviation for maintenance task / vedlikeholdsoppgave
MGB	Main Gear Box / hovedgearboks

N/A	Not Applicable / ikke relevant
NDL	Norwegian Defence Laboratories / Forsvarets laboratorier
NE	North East / nordøst
NF	Free turbine speed
nm	nautical miles
NR	Rotor speed
OPC	Operator Proficiency Check / operatørens ferdighetskontroll
OR	Outer Race
OTL	Operational Time Limit / maksimalt tillatt gangtid
PC	Proficiency Check / ferdighetskontroll
PCMCIA	Personal Computer Memory Card International Association
PSE	Principal Structural Element / vesentlige strukturelle elementer
QNH	Altimeter pressure setting to indicate elevation amsl / høydemålerinnstilling relatert til trykket ved havets overflate
R/H	Right Hand / høyre
rpm	revolutions per minute / omdreininger per minutt
RTS	Return to Service
RWY	Runway / rullebane
SB	Service Bulletin / informasjon gitt fra fabrikant
S/N	Serial Number / serienummer
SR	Safety Recommendation / sikkerhetstilråding
TAF	Terminal Aerodrome Forecast / værvarsel for flyplass
TRI	Type Rating Instructor / instruktør for typerettigheter
TSN	Time Since New / flytid siden ny
UTC	Coordinated Universal Time / universell standardtid
VHM	Vibration Health Monitoring / vibrasjonsovervåking
VOR	VHF Omnidirectional Radio Range / VHF retningsbestemmende radiofyr