

AIR ACCIDENT INVESTIGATION BOARD, NORWAY (AAIB/N)

REP.: 47/2001

**REPORT ON THE AIR ACCIDENT 8 SEPTEMBER 1997 IN THE
NORWEGIAN SEA APPROX. 100 NM WEST NORTH WEST OF
BRØNNØYSUND, INVOLVING EUROCOPTER AS 332L1 SUPER PUMA,
LN-OPG, OPERATED BY HELIKOPTER SERVICE AS**

This report has been translated into English and published by the AAIB/N to facilitate access by international readers. As accurate as the translation might be, the original Norwegian text takes precedence as the report of reference.

ISSUED NOVEMBER 2001

TABLE OF CONTENTS

1	Factual information	6
1.1	History of the flight	6
1.2	Injuries to persons.....	8
1.3	Damage to the aircraft	8
1.4	Other damage.....	8
1.5	Personnel information	8
1.6	Aircraft information.....	9
1.7	Meteorological information.....	43
1.8	Aids to navigation.....	45
1.9	Communications.....	46
1.10	Aerodrome information	46
1.11	Flight recorders.....	46
1.12	The accident location and the aircraft wreckage	50
1.13	Medical and pathological information.....	54
1.14	Fire.....	54
1.15	Survival aspects.....	54
1.16	Tests and research.....	57
1.17	Organisational and management information.....	77
1.18	Additional information	82
1.19	Useful or effective investigation techniques	91
2	Analysis	97
2.1	Introduction to the analysis.....	97
2.2	Analysis of the course of events during the flight on 8 September 1997	97
2.3	Causal factors significant to the course of events.....	100
2.4	Splined sleeve.....	111
2.5	An assessment of the period of failure development in the splined sleeve	124
2.6	A summary of the analysis of technical factors in sections 2.2 - 2.5.....	128
2.7	Steering documents - quality documentation, procedures and the people in the process.....	131
2.8	Inspections carried out by the NCAA.....	137
2.9	Maintenance performed in the company	139
2.10	HUMS	151
2.11	Tie-bolt fracture.....	154
2.12	Certification requirements.....	154
2.13	Fire.....	155
2.14	Survival potential	155
3	Conclusion.....	157
3.1	Results from the investigation.....	157
3.2	Significant investigation results	162
4	Recommendations	164
PART II		
5	Appendix	167

**AIR ACCIDENT 8 SEPTEMBER 1997 IN THE NORWEGIAN SEA
APPROX. 100 NM WEST NORTH WEST OF BRØNNØYSUND
INVOLVING EUROCOPTER AS 332L1 SUPER PUMA, LN-OPG,
OPERATED BY HELIKOPTER SERVICE AS**

Type designation: Eurocopter Super Puma AS 332L1

Registration: LN-OPG

Owned by: Helikopter Service AS
P.O. Box 522
NO-4055 Stavanger Lufthavn
Norway

User: Same as owner

Crew: 2

Passengers: 10

Accident location: Norwegian Sea 66° 04' 25"N 008° 34' 21"E

Date and time of accident: 8 September 1997, 06:56:30 hours

All times included in this report are stated in local time (UTC + 2 hours), unless otherwise indicated.

NOTIFICATION OF THE ACCIDENT

The Air Accident Investigation Board (AAIB/N) was notified of the accident on 8 September 1997 at 0740 hours by Bodø Air Traffic Control Center (ATCC). The message was to the effect that a Super Puma helicopter from Helikopter Service AS (HS) en route from Brønnøysund to the oil production vessel "Norne" was missing. An emergency call-out to Brønnøysund was arranged while contact was also set up with the parties concerned at Norway's Civil Aviation Authority (NCAA) [Luftfartsverket] and the Joint Rescue Coordination Center North-Norway [Hovedredningsentralen for Nord Norge]. The AAIB/N arrived at Brønnøysund that same day at 1500 hours.

In accordance with ICAO Annex 13, Aircraft Accident Investigation, the Bureau Enquêtes - Accidents (BEA), which is the Air Accident Investigation Board of France (the country of manufacture), was contacted. The BEA sent an accredited representative accompanied by advisers from the manufacturer of the helicopter, Eurocopter France (ECF), and the manufacturer of the engine, Turbomeca, to assist in the investigation.

SYNOPSIS

History of the flight

LN-OPG, a Eurocopter AS 332L1 Super Puma, was operated by Helikopter Service AS in a contract-based transportation service to the Norne Oil Field in the Norwegian Sea west of Brønnøysund. On 8 September 1997 at 0600 hours, the helicopter took off from Brønnøysund Airport on course for the oil production vessel "Norne". On board were a crew of two pilots and 10 passengers. The flight proceeded as normal on a standard IFR flight plan at an altitude of 2 000 ft until 0650 hours when the crew observed a short illumination from the overspeed (OVSP) light. The crew had no reason to assume that this was a serious warning signal. The helicopter approached the Norne, and the crew made contact with the Transocean Prospect oil rig, which was operating the radio station for the area. Communications with the Bodø Air Traffic Control Center (ATCC) were then terminated. A short time after this, the crew observed what they assumed to be further abnormal indicators in the cockpit. The ongoing fault in the axle between the right motor and the main gearbox now became critical. This led to the R/H and then the L/H power turbines burst (were torn apart). This meant that vital flight control rods were cut and the helicopter went completely out of control. Everyone onboard was killed when the helicopter hit the surface of the sea.

The direct cause of the accident

The helicopter was later located at a depth of 380 metres. The casualties and the helicopter were raised and investigations were initiated by the AAIB/N. This disclosed that the direct cause of the accident was that several fatigue cracks had occurred in a splined sleeve in the R/H shaft input of the main gearbox. This led to a lock washer getting into the power transmission shaft (Bendix shaft) of the R/H engine. This caused a large imbalance of the Bendix shaft and its subsequent failure. This gave rise to vibrations that caused malfunction of the engine's system for regulating and controlling the engine speed. As a result of this and the loss of loading due to the fracture in the Bendix shaft, the power turbine RPM rose out of control. When the number of revolutions reached approx 175%, the power turbine burst and fragments from this cut two flight control rods to the main rotor and the flight control rod for the tail rotor. It also destroyed the power turbine section on the L/H engine.

It has not been possible to establish with certainty what led to the fatigue cracking in the splined sleeve. A number of theories have been investigated without it being possible to link any one of these directly to the cracking. However, the AAIB/N has discovered two circumstances that may, independently or collectively, have led to the cracking. These are:

1 The state of the hardmetal coating on the splined sleeve

The hardmetal coating contained grains of carbide with larger diameter than the thickness of the coating. In places, the thickness of the coating was less than the specified value and it was discovered that the porosity of the coating was considerably

greater than the tolerance that was given. Furthermore, local lamination was found in the hardmetal coating and defective bonding was discovered between the base material and the hardmetal coating. The investigation has also shown that the coating had a number of scratches that cannot be linked to the sequence of events in the accident itself.

2 Vibrations from rotating components in the main gearbox (MGB)

Analyses of the Health and Usage Monitoring System (HUMS) data from LN-OPG show that the vibrations recorded from the MGB changed considerably in character and strength after MGB no. M170 was installed. Experiments have shown that certain combinations of input pinion and 8 000 RPM wheel can create increased vibrations in a gearbox. It is clear that LN-OPG contained components that produced this type of abnormal vibration pattern, but it have not been investigated which loads this has put on the splined sleeve.

Other information

The investigation has disclosed that the type MS9388-133 O-ring had not been installed on the R/H splined sleeve as assumed. The AAIB/N is of the opinion that it is doubtful that the fatigue cracks in the splined sleeve were initiated as a result of this. However, the subsequent growth in the crack may have been hastened by this deficiency.

The investigation indicates that the splined sleeve began to crack during the period between 22 and 31 August 1997. This was between 121 and 62 flying hours prior to the accident.

The investigation has shown that the safety potential of the HUMS was not fully realised. The accident has shown that the system can be a significant tool in preventing accidents, but that the system has to be given clear prioritisation by all of the parties involved in order for the greatest possible safety potential to be realised.

The investigation by the AAIB/N has revealed weaknesses in the maintenance programme used on the helicopter. In addition, it has uncovered deficiencies in the maintenance that was carried out by HS.

In its internal annual report on quality, health, safety and the environment, the company has stated that the principal manuals are in good condition and provide a good basis for managing and directing the many activities of the company. This includes those manuals that document the technical quality system. The AAIB/N does not entirely agree with this. The AAIB/N expresses doubt about the "accuracy and integrity" of the company's technical quality system. A systematic appraisal of these manuals has made the AAIB/N of the opinion that there is considerable room for improvement in the documents. In the opinion of AAIB/N, such improvement would be an important step in the ongoing process of quality improvement that should take place in the organisation.

As a result of this investigation, the AAIB/N has made 18 recommendations to the Norwegian Civil Aviation Authority [Luftfartstilsynet], the Norwegian Civil Aviation Administration [Luftfartsverket (post reorganisation)] and the helicopter company. These are listed under paragraph 4.

1 FACTUAL INFORMATION

1.1 History of the flight

- 1.1.1 On a contractual basis, Helikopter Service AS carried out transportation services for Statoil, including services from Brønnøysund Airport (ENBN) to the oil installations in the Heidrun and Norne fields in the Norwegian Sea.
- 1.1.2 The first planned flight from Brønnøysund on Monday, 8 September 1997, was to the oil production ship Norne (XNNE). The working day for the aircraft technician (an aircraft technician in this report means a licensed aircraft technician [ICAO II licence]) started at 0430 hours. According to the aircraft technician, the Pre Flight Check (PFC) was carried out inside the hangar without anything abnormal being discovered. However, by mistake, he did not enter into the Daily Maintenance Record (DMR) the fact that the PFC had been carried out. The crew, consisting of two pilots, arrived at the airport at around 0515 hours. They planned and prepared the flight, which was estimated as lasting 1 hour and 6 minutes. Fuel consumption was estimated as being 512 kg. Because weather conditions were acceptable and the estimated take-off weight was low, (only 10 passengers, little baggage and no cargo), extra fuel could be taken along, and it was decided to fill up with 1 700 kg of fuel. Notification of this was given to the aircraft technician, who had meanwhile towed out the helicopter and prepared it for refuelling. The number of litres filled was entered into the DMR by the aircraft technician. After refuelling, the helicopter was towed to the start-up area and the crew and the passengers arrived. In order that the helicopter's centre of gravity should be within the set limits, three of the seats in the forward row of seats were blocked off. The pilot-in-command accepted charge of the helicopter and entered his signature in the DMR without noticing that there was no PFC entry.
- 1.1.3 The crew was dressed in the company's dark blue non-insulated flying suits and the passengers were dressed in type-approved orange survival suits.
- 1.1.4 The helicopter, a Eurocopter AS 332L1 Super Puma, was loaded and ready for start-up at 0548. The crew made contact with Brønnøysund AFIS (Aerodrome Flight Information Service), which informed them that the runway in use was 22, the wind was 260°, 6 kt and QNH was 990 hPa. The call sign HKS 451 was used. The flight had been planned in accordance with a standard IFR repetitive flight plan from Brønnøysund to reporting point HELIK, further along route TANGO to TANGO 90 and then directly to the Norne (see fig. 1). ENBN was the alternative landing location. The entire flight was to take place in uncontrolled airspace, class G.

- 1.1.5 The two engines of the helicopter were started up and it taxied out to the runway. Via ENBN AFIS from the Bodø Air Traffic Control Center (ATCC), HKS 451 received clearance to the Norne via route TANGO at an altitude of 2 000 ft. SSR transponder code 4540 was given. The crew confirmed the clearance from Bodø ATCC. At 0600 hours, LN-OPG took off from runway 22 and climbed to an altitude of 2 000 ft. Passing HELIK was reported to ENBN AFIS at 0612 hours, and the helicopter was then transferred to Bodø ATCC.
- 1.1.6 At 0614 hours, the crew made contact with Bodø ATCC, and the information was given that the estimated time of passing TANGO 30 was 0619 hours with arrival at the Norne at 0706 hours. Bodø ATCC confirmed receipt of this, and informed them that they had radar contact with HKS 451.
- 1.1.7 The flight, primarily taking place under Instrument Meteorological Conditions (IMC), was carried out by the pilot-in-command, while communication was performed by the co-pilot. The subsequent description is based principally on information retrieved from the helicopter's Cockpit Voice Recorder (CVR).
- 1.1.8 At 06:50:07 hours, the crew observed that an indicator light had lit up for a short time. A comment was made that "that was strange". The crew gradually agreed that it was the overspeed light (OVSP) for the R/H engine that had been lit. The co-pilot then read out two lines from the emergency checklist under the heading ENGINE OVERSPEED - FLASHING -, but no further indications were recorded to show that checklists had been consulted.
- 1.1.9 At 06:52:41 hours, the crew made contact with the radio station on the oil rig, Transocean Prospect which was stationed close to the Norne. It was this station that had radio contact with any helicopters that were to land on the Norne. This was a practical arrangement since radio personnel on the Norne had little experience of helicopter operations. The crew received normal traffic and weather information for the Norne and Heidrun oil field. The weather conditions for landing on the Norne were good. The radio station on the Transocean Prospect received no information from HKS 451 regarding any technical or operational problems.
- 1.1.10 At 06:54:42 hours, HKS 452 reported to Bodø ATCC that they were in contact with the Norne and that they were leaving 2 000 ft, with an estimated time of arrival of 0705 hours. Bodø ATCC confirmed this and requested a report after landing on the Norne, which was confirmed. This was the last radio communication from HKS 451. No information regarding any form of technical or operational problem was sent to Bodø ATCC.
- 1.1.11 The conversation between the pilots indicates that the abnormal indications recurred at 06:55:37 hours, and that something "very strange" was observed at 06:55:55 hours. According to the recordings made by the helicopter's CVR, a thud was heard at 06:56:30 hours; then, after a loud crunching sound 1.7 seconds later, the helicopter went completely out of control. The helicopter then fell down towards the sea, out of control. All of those onboard were killed as a result of the impact with the surface of the sea.

1.2 Injuries to persons

CASUALTIES	CREW	PASSENGERS	OTHERS
FATALITIES	2	10	
INJURED			
LIGHT/NONE			

1.3 Damage to the aircraft

The helicopter was a total loss.

1.4 Other damage

None.

1.5 Personnel information

1.5.1 Pilot-in-command

1.5.1.1 The pilot-in-command, a man aged 37, possessed a Commercial Pilot's Licence for helicopters, ATPL-H, valid for AS 332, HU 269, Bell 204 and Bell 205. The licence was valid until 31 August 1998. His last medical examination for a Commercial Pilot's Licence had been carried out on 10 December 1996 and it was valid until 31 December 1997. The pilot-in-command's periodic flight training was valid until 30 September 1997.

1.5.1.2 The pilot-in-command began his flying career in the Norwegian Air Force [Luftforsvaret] in 1980. He served in the Air Force for around 10 years and completed the last 2 years of his period of service as Squadron Leader in 337 Squadron at Bardufoss.

1.5.1.3 On 1 June 1990, the pilot-in-command took up a post at Braathens Helikopter AS and transferred to Helikopter Service AS through the merger in 1994. He was appointed captain in 1992 and also served as an instructor at HS.

1.5.1.4 The pilot-in-command had flown 278:20 flying hours during the previous year and had accumulated a total of 4 945 hours of flying time.

1.5.1.5 Flying time status

FLYING TIME	TOTAL	THIS TYPE
LAST 24 HOURS	:55	:55
LAST 3 DAYS	5:10	5:10
LAST 30 DAYS	52:05	52:05
LAST 90 DAYS	97:50	97:50

1.5.1.6 The pilot-in-command did not do any flying during the day prior to the accident, but had been on stand-by which was recorded as 2:15 hours in working time. Work started at around 0515 hours on the day of the accident.

1.5.2 The co-pilot

1.5.2.1 The co-pilot, a man aged 55, possessed a Commercial Pilot's Licence for helicopters, CPL-H, which was valid for the following types: Bell 212, AS 332 and HU 269. The licence was valid until 28 September 1997. The co-pilot's periodic flight training was valid until 31 October 1997. His last medical test for the Commercial Pilot's Licence was on 18 February 1997. The test was valid until 28 September 1997.

1.5.2.2 The co-pilot started his flying career at a flying school in Sweden. For a long period, he then flew both fixed-wing aircraft and helicopters in Sweden and Norway. On fixed-wing aircraft, the co-pilot had a flying time of 3 828 hours. He was first employed within the Helikopter Service AS Ski- and Seaplane Department at Fornebu. In 1976, he was checked out on Bell 212s and for 7 years he flew shuttles on Ekofisk. In 1983, he was checked out on AS 332 Ls. At the time of the accident, he had a total flying time of 9 181:30 hours.

1.5.2.3 Flying time status

FLYING TIME	TOTAL	THIS TYPE
LAST 24 HOURS	0:55	0:55
LAST 3 DAYS	5:10	5:10
LAST 30 DAYS	41:10	41:10
LAST 90 DAYS	121:20	121:20

1.5.2.4 The co-pilot had the same service programme at Brønnøysund as the pilot-in-command. It must therefore be assumed that he was rested on starting work at around 0515 hours on the day of the accident.

1.6 **Aircraft information**

1.6.1 General description of the helicopter

The helicopter, an AS 332L1 Super Puma, is of medium size, with two engines. It is built to accommodate a maximum of 24 passengers (see fig. 2). At HS, the type is configured for a maximum of 19 passengers. The cabin and tail are built of aluminium in the traditional manner. The helicopter has a four-bladed main rotor and a five-bladed tail rotor. The rotor blades are of the composite type.

As with many equivalent helicopters, the type is built in compliance with military specifications, being adapted later for civil specifications. Thus, the AS 332L1 is a further development of the Aerospatiale SA 330 Puma which was developed to meet specifications set by the French Army. The prototype of the SA 330 flew for the first time in 1965. The helicopter underwent considerable alteration with equipment such as different engines, new gear drives and a larger cabin when the AS 332 was introduced.

A lengthened version of this, with the designation AS 332L (as opposed to the AS 332C which is of "standard" length), was supplied to the market in 1982. The subsequent model, the AS 332L1, arrived on the market in 1986. This was given more powerful engines, but is otherwise very similar to the AS 332L. The newest version used for transportation to oil installations is the AS 332L2. This was supplied to the operating companies in 1992 and is different to its predecessor with regard to the rotor system, among other things. As is clear from this summary, there is great technical similarity with extensive use of identical solutions in several versions of the AS 332. When the report refers to the AS 332L1, this will therefore be relevant to the AS 332C, AS 332L and AS 332C1 to a great extent also.

The AS 332L1 is type-certificated in accordance with FAR 29 amendments 1 to 16.

1.6.2 Data for the helicopter

Manufacturer:	Eurocopter France (ECF)
Type/model:	AS 332L1 Super Puma
Year of construction:	1991
Serial number:	2344
Total operating time:	7 796 hours
Engine type:	2 x Turbomeca Makila 1A1
Serial number, L/H engine:	2479
Serial number, R/H engine:	2478
Serial number, MGB:	M170
Operating time since overhaul (MGB):	613 hours
Part number R/H input pinion	332A32-2145-24
Serial number R/H input pinion	M1809
Part number, R/H 8 000 RPM wheel	332A32-2150-32
Serial number, R/H 8 000 RPM wheel	M541
Part number, R/H Bendix shaft:	19E226-8A
Serial number, R/H Bendix shaft:	1796U
Part number, R/H splined sleeve:	332A32-2288-22

Part number, R/H splined flange:	332A54-2008-22
Part number, R/H lock nut:	SLN40365M30X1-5
Part number, R/H lock washer:	SLW40-365DM30
Maximum take-off mass:	8 600 kg

On departure from Brønnøysund, the helicopter had a take-off mass of 8 340 kg. With three seats on the front row blocked off, the helicopter was within the limits with regard to the location of the centre of gravity.

On departure, there were 1 700 kg of JET A-1 type fuel on board.

The helicopter was operated by AS Mørefly from 1 July 1991 to 4 April 1995.

1.6.3 Description of the engines, power transmission shaft and main gearbox

1.6.3.1 *Description of the engines*

Two turboshaft engines of the Turbomeca Makila 1A1 type are mounted up on the forward section of the passenger compartment (see fig. 2). The engines are located alongside one another, at a distance of 20 cm and with a firewall between. Each engine weighs 241 kg and can supply output power of 1 300 kW (1 742 hp) at a speed of 22 850 revolutions per minute on the output shaft (100% Nf). The engine can generally be subdivided into a gas generator section and a power turbine section (also called module no. 5 and free turbine in the helicopter's technical documentation). The rotating parts are supported by six bearings, numbered consecutively from the front of the engine (see fig. 3). The gas generator consists principally of a three-stage axial compressor, a radial compressor, a combustion chamber section and a two-stage turbine. The RPM of the gas generator is designated Ng. The temperature of the turbine (T4) is recorded by sensors located between the gas generator's turbine and the power turbine.

The power turbine section consists of two turbines mounted together and which rotate freely, independent of the gas generator. These are supported by a roller bearing at the front (bearing no. 5) and a ball bearing at the back (bearing no. 6). The rotating parts in the turbine consist of a shaft section, mounted in bearing no. 5, two separate turbine discs and one output shaft, mounted in bearing no. 6. These components are hollow and are linked together by a through tie-bolt combined with Curvic couplings (see fig. 3). A protective steel band (containment ring) for each turbine stage is fitted around the outside of the turbine housing to prevent the possibility of a loose turbine blade being expelled from the engine. This ring is not designed to tolerate a disc burst. Behind the ball bearing on the turbine shaft, there are three wheels with external teeth (phonic wheels) which act as signal transmitters to an RPM recording system. The RPM of the power turbine is designated Nf.

A power transmission shaft, hereinafter called the Bendix shaft, but also called the high speed shaft, transmission shaft or engine-to-MGB coupling shaft in the helicopter's technical documentation, is bolted to the power turbine shaft and runs back to the helicopter's main gearbox (MGB). This shaft is not part of the engine and is therefore not supplied by the engine manufacturer.

Each engine is attached to the roof above the passenger compartment using two links that allow the engine limited freedom of longitudinal movement (see Appendix B, fig. 1). A tube on the outside of the Bendix shaft, hereinafter called the liaison tube, but also called the linking tube and coupling tube in the helicopter's technical documentation, is bolted at one end to the housing of bearing no. 6. The tube then goes through the engine's exhaust pipe and is bolted to the main gearbox (MGB) at the other end. This tube, which also constitutes the rear engine mounting, is articulated and has freedom of movement of 2° in two axes. The three bolts that attach the liaison tube to the MGB are hereinafter called the tie-bolts (note that this bolts has nothing in common with the tie bolt that is inside the power turbine section). During maintenance work that requires access to the area between the Bendix shaft and the MGB, these can be loosened and the engine can then be moved forward. A set of supporting legs enables the engine to be moved further forward once the two front links are disconnected.

In addition to the firewall that separates the two engines there are also firewalls that protects the cabin and the MGB against fire and heat.

1.6.3.2 *The engine's regulation and control system*

Each engine is regulated and controlled separately by an analogue Engine Electronic Control Unit (EECU), among other devices. This unit automatically regulates the engines during engine start and normal operations. Two systems in the EECU (one for RPM regulation and one for RPM limitation) are important elements in being able to understand the accident. These are described below:

To carry out RPM regulation and to prevent the power turbine attaining excessive rotational speed (overspeed protection), information about the power turbine RPM (Nf) is required. This RPM information is provided by two speed probes that are mounted in two slits in the liaison tube, immediately outside the phonic wheels mentioned above (see fig. 3 and Appendix D). According to the factory, the largest permissible distance between speed probes and phonic wheel is 0.6 mm. Each speed probe contains three speed sensors for a total of six sensors. The sensors, which are of the induction type, record changes in flux when a tooth from the phonic wheel goes past. The three sensors in a speed probe supply respective signals to three separate channels in the unit for RPM regulation in the EECU. From the second speed probe, two signals are sent to a unit in the EECU to allow engine shut-down in the event of limit exceedance. The third signal is sent to the Nf indicator in the cockpit, to a power calculator and to the Combined Voice and Flight Data Recorder (CVFDR).

The system for RPM regulation regulates in accordance with a majority decision if the signals from the three channels vary internally. A monitoring system checks that all channels are receiving signals. In the event of a loss of information from one or more

channels, an amber GOV light should light up on Sub-panel 34 in the cockpit (see fig. 4). If the EECU loses all Nf information, the control unit will increase the supply of fuel to the engine so that an engine speed of 104% Ng is obtained (maximum power available).

The system for RPM limitation should actuate at 120% Nf and cut the engine's fuel supply via the Overspeed Shut-off Valve. The system that is controlled by the EECU must be de-actuated manually once it has been actuated. An amber OVSP light on Sub panel 34 in the cockpit comes on if one or both of the channels lose the signal or if the signal is equivalent to an engine speed of less than 25% Nf. The same light will remain on and flash if the system for RPM limitation has been actuated.

Turbomeca has developed a mathematical model of the ability to react to the system for RPM regulation on the Makila engine. The model has been adjusted, to a certain extent, on the basis of full-scale tests. The calculations show that, without assistance from the overspeed system, the system for RPM regulation can handle a fracture in the Bendix shaft and that the RPM reaches 128% Nf before it is brought under control. These calculations are based on a power output of approx. 40% (89% Ng). Calculations show that the equivalent figure will be 154% Nf if the fracture takes place at 100% Ng. Turbomeca has provided the information that the critical RPM, at which the power turbine burst could occur, is 180% Nf.

1.6.3.3 *Main Gearbox (MGB)*

The helicopter's main gearbox is mounted behind the engines up on the roof above the passenger compartment. The gearbox is attached by three suspension bars and a flexible titanium plate (see fig. 2). The general structure of the gearbox is shown in fig. 5. The Bendix shafts from the R/H and L/H engines, respectively, are connected to the shaft inputs on the gearbox. Gearing the engine speed down to 7 960 revolutions per minute (100% Nf) takes place at the front of the gearbox (front reduction gear). The relevant gears have 31 teeth (input pinion) and 89 teeth (8 000 RPM wheel), respectively. The torque that is transferred is measured as the torsion of a horizontal shaft (torquemeter shaft) and can be read off in the cockpit as the torque (Tq). At the rear end of the shaft, there is a free wheel that permits the respective engine to stand still even if the rotors are rotating. Behind the free wheel, the shafts from the R/H and L/H engines are connected together via respective gears with 35 teeth (free wheel gear), and a combiner gear that has 57 teeth. After this, the engine speed is geared down via a chevron gear and two epicyclic gears to a main rotor speed of 265 revolutions per minute. The speed of the main rotor is designated Nr.

A shaft input on the gearbox is shown in fig. 6. It consists of an input pinion (fig. 6: MGB pinion) with external splines (teeth). On the outside, there is a splined sleeve with internal and external splines. This is made of steel with an external coating of tungsten carbide. Tungsten carbide is a hardmetal that provides the surface with high wear resistance. The splined sleeve is held in place by a lock nut (see also fig. 29) which is again locked by a lock washer that weighs 59 g (see also fig. 28). The lock washer engages with four slots in the lock nut and is prevented from rotating because the lock washer and splined sleeve mesh with each other by means of small splines

(micro splines). To prevent the lock washer falling out, it is retained by a circlip (C-ring) that is located in a groove between the lock washer and the splined sleeve. A type MS9388-133 O-ring is located in an external groove behind the splined sleeve.

The interval between complete overhauls of the MGB is 3 000 operating hours.

1.6.3.4 *Bendix shaft*

Between each engine and the main gearbox, there is a shaft - previously called the Bendix shaft (see fig. 2). This shaft, which goes inside the liaison tube, consists of a thin-walled tube with a flange at each end. The front end is bolted onto the engine and the rear end is bolted onto a splined flange (end-piece). The splined flange goes outside the main gearbox splined sleeve and, during installation, this locates with the splined sleeve when the engine is slid back into position. The splined flange is made of the same material as the splined sleeve, but the surface has no hardmetal coating. Close to the ends, the shaft has a flexible section (bellows), intended to permit relative movement between the engine and the main gearbox. These bellows are designed such that, in the event of overload, they will fail before the shaft tube. In the event of a fracture in the bellows, the shaft tube itself will remain centred around the cylindrical part of the splined flange or a corresponding centring piece at the engine end. These centring functions of the Bendix shaft are referred to by ECF as the Fail safe bearing (see fig. 6).

1.6.4 Health and Usage Monitoring System (HUMS)

1.6.4.1 *HUMS - general description*

A simple description of HUMS is that it is a system for monitoring the status of technical components, principally shafts, bearings, gears and other rotating components. The level of vibration on these components is recorded by means of accelerometers. The data are then processed and stored without the system providing the crew with information while airborne. A data storage card is taken out of the helicopter and brought to a ground station for reading off at the end of each flight. Operational information from the flight thus becomes available from the ground station via a terminal. A supplementary list of information (the HUMS log report) is then printed out on a printer linked to the ground station. Among the details provided by this list are information regarding any limit values that have been exceeded and descriptions of failures in HUMS. Much of the stored information must be analysed manually and this can provide valuable additional information during troubleshooting. HS has three types of HUMS installed in its helicopters:

- North Sea HUMS - the first system that was implemented by HS. Installed/utilized in the Boeing 234LR and in the Sikorsky S-61
- IHUMS - a system developed in a joint venture between GKN Westland Helicopters and Bristow Helicopters Limited. Installed in the Eurocopter AS 332L1

- Euro HUMS - developed by ECF and installed as optional equipment by the helicopter manufacturer on the Eurocopter AS 332L2 helicopters and retrofitted by HS on the Eurocopter AS 332L helicopters.

HUMS is not included in the helicopter's type certificate, but has been given special approval by various civil aviation authorities for use in aircraft.

1.6.4.2 *HUMS - general background*

Because of worries about a generally poor standard of safety for helicopters (when compared to fixed wing airline operations) in the late 1970s and early 1980s, the Civil Aviation Authority (CAA) in England appointed a Helicopter Airworthiness Review Panel (HARP) which reported in June 1984 (CAP 491). The following is quoted from page 23 of the report:

"What the panel would wish to propose is a philosophy based on the argument that where full redundancy is not possible in the design of helicopters warning of likely failure (at some reasonable period ahead in time, maybe only an hour or two) could provide the overall safety level."

This then led to a group being appointed (the Working Group on Helicopter Health Monitoring), which presented its report in August 1985 (CAA paper 85012). The group concludes that a system may not only be useful on new helicopter types, but can also be installed on existing models. The report gave reasons for the development of HUMS.

During the period 1986 to 1990, there were seven in part very serious accidents with British-registered helicopters. On the basis of each of these accidents, the Air Accidents Investigation Branch (AAIB) in England made almost identically worded recommendations to the CAA in which it indicated a need for vibration monitoring of the rotating parts of the helicopters. This acted as a catalyst for developing and installing HUMS.

In the last half of the 1980s, the British helicopter company Bristow Helicopters Limited, in conjunction with the helicopter manufacturer GKN Westland Helicopters and several electronics manufacturers, started development work on a prototype of HUMS. Testing this system showed that it could be produced industrially and implemented. The oil companies in the British sector were instigators of this work and participated considerably in financing the development and installation work. The British CAA made a contribution as coordinator in the work, but did not make installation of the system mandatory. The first installations in the British sector were approved by the CAA in accordance with the No Hazard, No Credit principle. This means that the system should not diminish or affect the safety of the helicopter, and should not lead to any reduction in mandatory maintenance. At this time, requirements were specified for the installation of Flight Data Recorders (FDRs) in helicopters operating in the British sector. This contributed to a reduction in extra costs during the installation of HUMS, since a large part of the components in the FDR system could be used jointly with HUMS.

In 1990, HS contacted several oil companies to investigate interest in the system and, if possible, to coordinate installation in helicopters in the Norwegian sector of the North Sea. In collaboration with Boeing, HS started installation of HUMS in a Boeing 234LR in 1991, but the first helicopter to fly using HUMS in Norway was the company's Sikorsky S-61, LN-OQI. A short time later, Braathens Helicopter and Mørefly AS started flying with HUMS installed.

In 1990, SINTEF issued a report on the basis of a comprehensive Helicopter Safety Study of helicopter transport in the North Sea area. Apart from describing the risk areas that were found, it also proposed improvements. The following quotation is taken from a Technical reliability summary:

"Major areas for improvement include systems for collection and utilization of performance data and further development of Health and Usage Monitoring Systems (HUMS), providing early warning of imminent failures."

In general, it could be said that, early in the 1990s, HUMS had a high profile in those fora in which helicopter safety was being discussed.

1.6.4.3 *The attitude of NCAA to HUMS*

After the accident, the AAIB/N wrote to the NCAA and raised a series of questions regarding HUMS. In its letter of reply, the NCAA shows that, as early as 1983, they participated in a project in the Part 29 Group in which Monitoring Systems were evaluated for increasing helicopter safety. On request by the Board, however, it was indicated on the part of HS that the NCAA had a passive attitude to the helicopter operators with regard to HUMS right up until the time when the equipment was going to be installed in Norway. When HUMS was fitted into a Norwegian helicopter for the first time in 1991, it was approved by the NCAA in accordance with the British No Hazard, No Credit model. The term was explained as follows in the letter of reply from the NCAA:

"...the system shall not have any negative effect on the other systems. Data from using HUMS has not been used with the purpose of reducing maintenance requirements." (Translated from original Norwegian)

In September 1991, A/S Mørefly applied to the NCAA concerning the installation of IHUMS in the company's type AS 332L1 helicopters. In its letter of reply, the NCAA stated that further approval work was dependent on consultations with the British authorities. The subsequent approval of the system was awarded on the basis of modification review no. 3/92 issued by the NCAA. Among other things, this modification review was based on "CAA Approval No DAI/4798/56". In an English version of modification review no. 03/92, it states:

"This approval certifies that the modified design of the product stated below has been examined and found to be in compliance with the airworthiness requirements of the Norwegian regulations, BSL B 1-1."

On enquiry from the AAIB/N, regarding requirements applicable with regard to the maintenance of HUMS, the NCAA replied:

"Installed equipment shall be maintained and calibrated in accordance with the manufacturer's maintenance guidelines. The requirements were incorporated into the company's maintenance instructions." (Translated from original Norwegian)

No other preconditions were stipulated before the system was brought into service and no requirements were specified for trial arrangements or ongoing evaluation of the system. In addition, in its letter of reply to HSL, the NCAA stresses that the installation of HUMS is on a voluntary basis and that it is not an aviation requirement.

With regard to the future incorporation of HUMS into design requirements, the NCAA refers to the Design Assessment Requirements in the Joint Aviation Authorities' JAR 29 (refer to the certification requirements in subparagraph 1.6.5.7.).

1.6.4.4 *Experience of using IHUMS at HS*

In a meeting with the AAIB/N, representatives from the engineering management at HS explained that the available information regarding HUMS at an early stage indicated that the system had considerable flight safety potential. This was the motivation that led to its installation in the company's helicopters. The system that was first installed was fully developed with regard to components in the helicopter and the ground installation (hardware), but there were evident weaknesses in the software. The system was therefore not a finished product. In this context, key terms mentioned were customisation for helicopter types, system reliability and deficient stipulation of criteria. In addition, HUMS provided a new challenge to the maintenance organisation since HUMS information in combination with unclear criteria provided few tangible answers with regard to the assessment of a helicopter's airworthiness. This problem was further compounded by the fact that the system issued false alarms for long periods. At times, the problems were so great that it was almost a matter of questioning justification for the system as a whole. However, the potential of the system was shown on many occasions by faults being discovered at an early stage.

The engineering management at HS has also stated that, at an early stage, the relationship between the supplier of IHUMS and ECF became distant. The IHUMS supplier were unwilling to provide details of data recording and processing which ECF believed were vital for specifying limit values. ECF was therefore reticent about exchanging details of practical experience with regard to vibrations. This might be explained by the fact that ECF had been working on developing HUMS on its own helicopters (Euro HUMS), and therefore wanted to go into competition. HS felt that it was in a difficult situation because it had helicopters with IHUMS installed in accordance with specifications from another company (AS Mørefly), that the supplier of the system (Bristow) had been a direct competitor of HS in the helicopter market, and that the system supplier and helicopter manufacturer were not working together. This was a contributory cause of limit values not being set on a number of important

parameters that were monitored. Furthermore, experience had shown that there were major individual variations in the normal level of vibrations from the same component, depending on the time. There were also major variations in the normal level of vibrations depending on the helicopter in which the component was fitted. These variations could not be explained. It was also unclear which maintenance work should be implemented if limit values were exceeded. Periodically, it was also difficult to obtain spares for IHUMS and this made the problems even worse. A contributory explanation for the development of IHUMS not performing as expected was at the times limited financial resources of the system supplier.

The engineering management at HS has stated that the company over a long period had invested major resources into HUMS. The company had, for example, two employees working exclusively with the system.

1.6.4.5 *IHUMS in LN-OPG*

On commission from AS Mørefly, Bristow Helicopters Limited installed IHUMS into LN-OPG. Bristow had also developed this system. In practice, IHUMS means that, to a great extent, the signal sensor and signal processing are common to the CVFDR and HUMS. The HUMS information is received and processed by the Digital Acquisition and Processing Unit (DAPU) before being stored on a magnetic card which is placed in a cockpit unit (the Maintenance Data Recorder) prior to flying. This card is taken out on leaving the helicopter after the flight and the data are loaded into a ground station for further electronic processing. When a reading is taken from the information on the card, certain details from the flight can be read off immediately and confirmed via a terminal. This includes details of any incidences of exceeding operational parameters (T4, Tq or IAS too high etc). After a few minutes, a HUMS log report is printed out. This contains details of the status of the system itself and the exceeding of any parameters with set limit values. At the time of the accident, there were no standing orders in the company requiring the aircraft technicians carrying out inspections on the helicopter to read the HUMS log report. The report was used principally in troubleshooting or in the event of suspected faults.

The main gearbox on the LN-OPG was equipped with 7 signal sensors for vibrations (accelerometers) which monitored a series of parameters from 18 different areas of the gearbox. In addition, the system monitored a large number of other parameters including those from the engines and tail rotor operation. The following accelerometers are of particular interest in connection with the accident (see fig. 7):

- an accelerometer was mounted on the housing of each of the engine's two power turbines. No limit values were set for these and consequently they would not be able to warn of abnormally high values.
- an accelerometer was mounted near each of the shaft inputs on the main gearbox (DAPU channel nos. 1, 2, 3 and 4). These had set limit values and could warn of exceeded values. According to information given by GKN Westland Helicopters, the limit values were set at 4 g (1 g = acceleration due to gravity). The accelerometer on the R/H side was out of service at the time of the accident.

- an accelerometer mounted on the R/H side rear of the main gearbox (DAPU channel no. 6) recorded vibrations from this area, but only frequencies linked to the RPM of the torquemeter shaft were being monitored. Consequently, no warning could be given via this accelerometer regarding excessive vibration levels originating from the Bendix shaft.
- an accelerometer mounted on the front of the main gearbox (DAPU channel nos. 11 and 16) recorded vibrations from this area, but only frequencies linked to the epicyclic bearing of the gearbox were monitored. Consequently, no warning could be given via this accelerometer regarding excessive vibration levels originating from the Bendix shaft.

The rights and product liability for IHUMS have recently been taken over by BAE Systems.

1.6.4.6 *HUMS information from LN-OPG, recorded before the accident*

For various reasons, decibels (db), acceleration due to gravity (g) and Inches Per Second (IPS) have been used in the display of vibration data in this report. These units can be compared or converted. The relationship between "g" and "db" can be described thus:

$$(\text{LOG } g \times 20) + 60 = \text{db}$$

In conversions from "g" to IPS, RPM or frequency must be taken into account. This relationship can be described thus:

$$g \times (61.4/\text{RPM in Hz}) = \text{IPS}$$

The HUMS information from LN-OPG was analysed a short time after the accident. This showed that the level of vibrations on the R/H power turbine was tending to rise from around 18 August 1997. A clear increase in the vibration level in the area of the R/H engine/MGB was recorded on around 20 August. A considerable increase in the level of vibrations on the R/H power turbine took place between the readings on 2 and 3 September. The level of vibrations then became rather unstable, but on 7 September, the highest and last available value of a little over 7.0 g (approx. 1.1 IPS) was recorded (see fig. 60a and Appendix E. Note that there is no conformity between the given HUMS time and the flying time).

In addition, it was confirmed that the accelerometer on the main gearbox R/H input pinion had not been recording data after 21 June and that it was out of service at the time of the accident. In the last period before the accelerometer stopped sending signals, values of approx. 1.2 g were recorded.

Since there were no data from the gearbox R/H input pinion, an attempt was made to replace this by using stored raw data from the accelerometer mounted on the R/H side beside the epicyclic gear (refer to fig. 7). The result of this work is presented in Appendix E (EPI BRG FWD). The graphs of vibration level on the R/H power turbine

and the main gearbox L/H input pinion have also been displayed. These all point to the fact that the vibration level in the area had increased generally.

Because of the accident, HS implemented a major investigation into IHUMS information from the company's fleet of helicopters. GKN Westland Helicopters were given the task, and a summary of the result of this investigation has been reproduced under subparagraph 1.19.

1.6.4.7 *Operation and maintenance of HUMS*

In order that an aircraft should be able to commence flying, a minimum of systems and equipment must be functioning. This is regulated by a Minimum Equipment List (MEL). This list is normally drawn up by the company that operates the aircraft, and it must be approved by the NCAA. The MEL is based on a Master Minimum Equipment List (MMEL) which sets a minimum standard. The MMEL is normally drawn up by the civil aviation authorities in the country of manufacture, but the French civil aviation authorities have not drawn up an MMEL for AS 332L1. As a result, the NCAA has approved the fact that HS has used an MMEL for AS 332L drawn up by the Federal Aviation Authorities (FAA) in the USA. The requirement of this MMEL includes the Cockpit Voice Recorder (CVR) or Flight Data Recorder (FDR) to be functioning during a flight. The company has drawn up a Minimum Equipment List (MEL) based on the MMEL. One of the requirements specified in this is that the CVR should be functioning. In addition, there is an entry stating that HUMS "May be inoperative".

The NCAA requires HUMS to be maintained and calibrated in accordance with the manufacturer's maintenance instructions and guidelines. In addition, the requirements should be incorporated into the company's maintenance instructions. According to HS, this was taken care of, and the maintenance of IHUMS was implemented in accordance with "Bristow Helicopters Limited, AS 332L Maintenance Manual and Illustrated Parts List for the installation of an Integrated Health & Usage Monitoring System, Rev. 5. "This document lists a long series of maintenance requirements that have to be carried out at scheduled intervals. The following is a simplified summary with explanations:

- A Pre-Flight (an inspection that tests the functioning of CVFDR). The inspection was carried out on LN-OPG.
- B Daily (includes A with an additional inspection of magnetic and optical sensors). The inspection was carried out on LN-OPG.
- C Minor Inspection (Recommended) (This inspection is principally visual and is based on ensuring that equipment is mounted correctly and free from damage). The inspection was carried out on LN-OPG at an interval of 750 flying hours.
- D Major Inspection (Recommended) (This inspection includes testing of components and function tests). The inspection was not carried out on LN-OPG. However, the inspection points that deal with the CVFDR are covered by other inspections.
- E 50 Hours Out of Phase (inspection of Main Rotor Blade Tracker Window and Tail Gearbox Marker). The inspection was carried out on LN-OPG at an interval of 75 flying hours.

1.6.4.8 *HUMS in a supplier/client relationship*

The AAIB/N contacted all oil companies that included requirements for HUMS in their contracts with HS. The purpose was to gain an overview of the oil companies' role with regard to HUMS. Of the companies that replied, all were of the opinion that HUMS had a positive effect on flight safety. A few companies had contributed directly to financing the installation of the equipment, but none currently paid any specified additional sum for HUMS. Only one oil company had any HUMS requirement specified contractually:

"..., maintain the HUMS installed systems to ensure an operable condition, and ..."

However, one of the oil companies replied:

(the company) "has not specified any contractual requirements to HS concerning the maintenance of the HUMS installation, continuous operation, etc. On the other hand, the contract precisely specifies the total responsibility of HS for the operation and maintenance of the helicopters in general. When requirements for the installation and operation of HUMS are specified in the contract, this implies, on the part of both parties, a clear understanding that the HS liability entails documented, systematically controlled and quality assured operation of the system". (Translated from original Norwegian)

The AAIB/N has been given a partial insight into a contract between HS and an oil company that describes the helicopter's equipment. This describes the fact that the helicopter should be equipped with HUMS, without any further specification.

Prior to the accident, none of the oil companies had undertaken any evaluation of HUMS with regard to the accessibility of the system, operating problems or effects on flight safety during the years after the system was brought into use. After the accident however, some companies did point out that HS has been rather passive in relation to HUMS and warned that the system would be given a completely different focus in future by the oil companies. A representative of one oil company expressed to the AAIB/N the fact that they found it rather unsatisfactory that they, as client, considered themselves forced into having to take on liability for the safe execution of flights on the continental shelf. They considered it unfair that they had to build up their own expertise concerning helicopter transportation, in order to become the instigator in matters concerning flight safety. They regarded it as a problem that the Civil Aviation Authority/Norway had difficulty in grasping the special conditions surrounding flying on the continental shelf, and that the Civil Aviation Authority was too passive in this respect.

1.6.5 Certification requirements

1.6.5.1 *Introduction*

The type certificate for AS 332L1 is based on original type acceptance of the SA 330 F (DGAC type certificate no. 56) issued on 12 October 1970. The type certification is based on FAR 29. One condition for this certification is that the engines should be approved in accordance with FAR 33. On the basis of an application to the French civil aviation authorities (DGAC), dated 18 June 1984, AS 332L1 was granted a civil type certificate on 14 March 1985 based on FAR 29 amendments 1 to 16. The paragraphs below quote the relevant certification requirements:

1.6.5.2 *Requirements applicable to the engine installation in LN-OPG*

29.901

"(c) For each powerplant and auxiliary power unit installation, it must be established that no single failure or malfunction or probable combination of failures will jeopardize the safe operation of the rotorcraft except that--

- (1) The failure of structural elements need not be considered if the probability of such failure is extremely remote; and
- (2) The failure of engine rotor discs need not be considered."

29.903

"(f) *Turbine engine installation.* For turbine engine installations, the powerplant systems associated with engine control devices, systems, and instrumentation must be designed to give reasonable assurance that those engine operating limitations that adversely affect turbine rotor structural integrity will not be exceeded in service."

In 1982, Eurocopter issued a report on the probability of an Engine Disc Burst on the Makila 1A engine. It is clear from this document that the probability of a catastrophic failure due to disc burst is 10^{-7} . This calculation is based on disc burst due to structural failure in the rotating components, and does not take the possibility of a disc burst due to overspeed into account.

According to Eurocopter, the requirement in FAR 29.903 (f) was complied with as follows:

"The engine is stopped automatically if the free turbine rpm exceed 120%."

HUMS or other similar systems were not discussed in the certification requirements at this time.

1.6.5.3 *Requirements applicable to the engines in LN-OPG*

The Makila 1A1 engines were type certified in accordance with FAR 33 amendments 1 to 6

33.27

"(a) Turbine, compressor, and turbosupercharger rotors must have sufficient strength to withstand the rotor speed, temperature, and vibration test conditions specified in paragraph (c) in this section." (AAIB/N note: none of the points mentioned in (c) require testing of engine speeds of more than 120% of the max limiting rpm).

"(b) The design and function of engine control devices, systems, and instruments must give reasonable assurance that those engine operating limitations that affect turbine, compressor, and turbosupercharger rotor structural integrity will not be exceeded in service."

33.75

"Safety analysis.

It must be shown by analysis that any probable malfunction or any probable single or multiple failure, or any probable improper operation of the engine will not cause the engine to -

- (a) Catch fire;
- (b) Burst (penetrate its case);
- (c) Generate loads greater than those specified in Sec. 33.23; or
- (d) Lose the capability of being shut down."

1.6.5.4 *Requirements applicable to protection of the flight controls in LN-OPG*

The AAIB/N does not consider that there were any specific requirements in FAR 29 for protection of flight controls when AS 332L1 was type certified.

1.6.5.5 *Certification requirements applicable as at January 2000 for engine installation*

The applicable certification requirement is JAR 29, amendment 1. In these requirements, the exception for failure of rotor discs in FAR 29.901 is omitted. In addition, the following requirements have been added:

29.903

"(b) Category A: Engine isolation. For each category A rotorcraft, the powerplants must be arranged and isolated from each other to allow operation, in at least one configuration, so that the failure or malfunction of any engine, or the failure of any system that affect any engine will not --

- (1) Prevent the continued safe operation of the remaining engines; or
- (2) Require immediate action, other than normal pilot action with primary flight controls, by any crewmember to maintain safe operation."

and

"(f) Turbine engine installation. For turbine engine installations,

- (1) Design precautions must be taken to minimize the hazards to the rotorcraft in event of an engine rotor failure; and
- (2) The powerplant systems associated with engine control devices, systems, and instrumentation must be designed to give reasonable assurance that those engine operating limitations that adversely affect turbine rotor structural integrity will not be exceeded in service."

To expand on and explain the requirements in JAR 29, the Joint Aviation Authorities (JAA) have issued a series of Advisory Circulars (AC). The following quotations are taken from these:

AC 29.903C. § 29.903 (Amendment 29-1) TURBINE ENGINE INSTALLATION

"b. Procedures. Although turbine engine manufacturers are making efforts to reduce the probability of uncontained rotor failures, service experience shows that such failures continue to occur. Failures have resulted in high velocity fragment penetration of fuel tanks, adjacent structures, fuselage, system components and other engines of rotorcraft. Since it is unlikely that uncontained rotor failures can be completely eliminated, rotorcraft design precautions should be taken to minimize the hazard from such events. These design precautions should recognize rotorcraft design features that may differ significantly from that of an airplane, particularly regarding an engine location and its proximity to another engine or to other systems and components."

"d. Safety Assessment.

(1) Procedure. Assess the potential hazard to rotorcraft using the following procedure:

(i) Minimizing Rotorburst Hazard. The rotorburst hazard should be reduced to the lowest level that can be shown to be both technically feasible and economically justifiable. The extent of minimization that is possible will vary from new or amended certification projects and from design to design. Thus the effort to minimize must be determined uniquely for each certification project. Design precautions and techniques such as location, separation, isolation, redundancy, shielding, containment and/or other appropriate considerations should be employed, documented, agreed to by the certifying authority, and placed in the type data file. A discussion of these methods and techniques follows."

- F 6 Months Out of Phase (battery replacement in the IHUMS magnetic card). The batteries proved to have an individual working life and were replaced "On Condition".
- G 12 Months / 2000 Hours Out of Phase (bench test of CVFDR). The inspection was carried out on LN-OPG every 365 days or 2 500 flying hours.

In the Technical Report 87/97 dated 26 May 1997, it was pointed out that IHUMS on LN-OPG had been out of operation during the 72 flying hours that the helicopter had flown since its last G-check. It was further established that there was no requirement for any special check of IHUMS after the G-check. This led to a resolution on 11 June 1997 that the inspection cards for G-checks should be altered so as to apply to IHUMS function testing as well. This procedure had not been incorporated when the accident occurred.

A review of the helicopter's Daily Maintenance Record (DMR) from LN-OPG has shown that a lot of troubleshooting had been done on IHUMS during the period since the last G-check, but that the work only partly led to the system working as intended. For example, it might be mentioned that the accelerometer for the main gearbox R/H input pinion was replaced on 3 June 1997, but that it again ceased to function on 21 June. A new accelerometer was ordered for the main gearbox R/H input pinion on 24 August, but this had not yet arrived at the time of the accident.

During a review of the Print-out of complaints for the period 18 August 1996 to 8 September 1997, it was found that there was a total of 15 reports of failures or problems with the IHUMS on LN-OPG. It is essentially faults such as these that, in addition to affecting HUMS, also put the CVFDR out of service. The reports are therefore a logical consequence of the helicopter being grounded because the requirement in the MEL stipulates that the CVR should be functioning.

Licensed aircraft technicians at HS have explained that HUMS failures occurred so frequently that, over time, it had become common practice not to enter failures in the system into the DMR. This led to the possibility that parts of the system could be out of service for varying periods without this being evident from the Print-out of complaints.

After the accident, HUMS again came into focus. The company's management has explained that the accident graphically illustrated that the status of the system was not satisfactory, that it lacked clear objectives and that procedures were deficient. At the same time, the clients (the oil companies) were questioning the company's handling of HUMS. As a result of this, the company undertook a full review of the problems linked to HUMS, and took measures such as the specification of requirements for the system's functional ability despite the fact that it was not an airworthiness requirement. The accident also led to equipment suppliers, civil aviation authorities and other helicopter operators focusing on HUMS, something which has meant a considerable improvement of the system.

"(2) (v) Critical Engine Speed. Where energy considerations are relevant, the uncontained rotor event should be assumed to occur at the engine shaft speed for the maximum rating appropriate to the flight phase (exclusive of OEI ratings), unless the most probable mode of failure would be expected to result in the engine rotor reaching a red line speed or a design burst speed."

"(5) Engine Service History/Design.

(i) For the purpose of a gross assessment of the vulnerability of the rotorcraft to an uncontained rotorburst, it must be taken that an uncontained engine rotorburst failure (burst) will occur. However, in determining the overall risk to the rotorcraft, engine service history and engine design features should be included in showing compliance with § 29.903 to minimize the hazard from uncontained rotor failures. This is extremely important since the engine design and/or the service history may provide valuable information in assessing the potential for a rotorburst occurring and this should be considered in the overall safety analysis."

"e. Design Considerations.

(1) (vi) Critical control systems, such as primary and secondary flight controls, electrical power cables, systems and wiring, hydraulic systems, engines control systems, flammable fluid shut-off valves, and the associated actuation wiring or cables."

"f. Protective Measures.

(1) (i) Engine Rotor Fragment Containment. It should be clearly understood that containment of rotor fragments is not a requirement. However, it is one of many options that may be used to minimize the hazards of an engine rotorburst."

1.6.5.6 *Certification requirements applicable as at January 2000 for engines*

Applicable requirements have rather smaller changes in relation to the requirements from 1985. Particularly interesting is an addition to the requirements given in 33.27 item (a) (refer to subparagraph 1.6.5.3):

"(vi) The highest speed that would result from the failure of any component or system in a representative installation of the engine, in combination with any failure of component or system that would not normally be detected during a routine preflight check or during normal flight operation."

In addition, the definition of Burst in 33.75 item (b) has been changed from "penetrate its case" to "release hazardous fragments through the engine case"

1.6.5.7 *Other relevant certification requirements applicable as at January 2000*

JAR/FAR 29.601 contains a general requirement for design:

"(a) The rotorcraft may have no design features that experience has shown to be hazardous or unreliable.

(b) The suitability of each questionable design detail and part must be established by tests."

JAR/FAR 29.917 contains requirements for the design of a Rotor Drive System:

"(b) *Design assessment.* A design assessment must be performed to ensure that the rotor drive system functions safely over the full range of conditions for which certification is sought. The design assessment must include a detailed failure analysis to identify all failures that will prevent continued safe flight or safe landing and must identify the means to minimize the likelihood of their occurrence."

AC 29 - 2C, § 29.917 (amendment 29-40) Design, item e, contains the following reference to HUMS:

"(2) Compensating provisions may be selected from one or more of those listed below, but not necessarily limited to this list

(ix) Safety devices or health monitoring means beyond those identified in paragraphs (vi) and (vii) above."

The AAIB/N cannot see that there are any requirements in the applicable JAR/FAR with regard to the protection of flight controls against fragments expelled by the engines, for example.

1.6.6 The history of the helicopter

1.6.6.1 *In general*

The helicopter was built by ECF in 1991, and was operated by AS Mørefly from 1 July 1991 until 4 April 1995. LN-OPG flew 4 892 flying hours during this period. The helicopter was then taken over by HS as part of the merger with Mørefly and was operated by the company until the time of the accident. Please refer to subparagraph 1.18.1. for a description of the helicopter's maintenance instructions and associated procedures.

1.6.6.2 *Overhaul of main gearbox (MGB) M170*

One main gearbox with the serial no. M170 was removed from helicopter LN-OLA on 1 November 1996 and transferred to the gearbox workshop at HS for overhaul. The

gearbox had accumulated 2 938 flying hours and the overhaul interval is 3 000 flying hours. The work was carried out in accordance with work order no. 9604862. From the results documentation from the overhaul, it is clear that some parts had to be taken out and replaced with the following new parts (see fig. 6):

- Pinion gear, input	332A32-2145-24 M1809(R/H)
- Shaft, free wheel	332A32-2190-25 M477(R/H)
- Shaft, free wheel	332A32-2190-25M481(L/H)
- Shaft, torquemeter	332A32-2186-00M1809(R/H)
- Shaft, torquemeter	332A32-2186-00M1542(L/H)

Pinion gear, input (previously referred to as input pinion) was replaced due to fretting on ball bearing surface.

The gearbox was overhauled according to criteria stipulated in the Overhaul Manual MRV 63.28.10.800. This requires all teeth on gears to be visually inspected, among other things. There is no general requirement for control measurement of the wear on the teeth. This is described as follows in the general requirements in MRV 63.00.30.800:

"Check dimensions indicated on work cards for areas showing signs of damage or wear"

Fig. 8 shows an example of a job card applicable to the 8 000 RPM wheel. It is clear that the measurements for the external teeth should be 218.519 - 218.621 mm. Equivalent measurements for the external teeth on the input pinion are 82.556 - 82.642 mm.

Since the splined sleeves do not have individual serial numbers (maintenance according to the maintenance process "On Condition" OC), and are consequently difficult to monitor with regard to operating time, the only thing known is that they had been subject to an inspection without remarks. The work was carried out in accordance with the Main Task numbers 523, 532, 534 and 543. These are working documents written by HS (see subparagraph 1.18.1.2 for supplementary information on the Main Task). Under the Main Task number 534, Subtask No. 2625-01 item 51, there is "Install O-ring and blank. LH and RH." The engineering department at HS has provided the information that preparing packages of parts was a considerable contribution to good quality practices. Such a package contained parts that were included in the individual work operations during an overhaul. After a work operation was completed, the reason for any parts being left over was investigated. A forgotten gasket would therefore be noted as a non-conformance. A printout of the Stock Order from work order no. 9604862 shows that two type MS9388-133 O-rings were ordered and used. After the overhaul, the gearbox was test run on the test bench, and according to the technician who carried out the work, a missing O-ring on the input pinion would easily have been discovered.

According to JAA Form One, M170 was given a Certificate of Release to Service on 13 March 1997.

1.6.6.3 *G-check*

The helicopter underwent a G-check during the period 17 January to 3 May 1997. (613 flying hours prior to the accident.) This inspection should be carried out at intervals of 7 500 flying hours. Main gearbox M170 was installed during this period. According to technical documentation, the gearbox was installed in LN-OPG on 30 April 1997. During the work, Main Task 414-01 was used, and there is a signature on this document to confirm that the O-ring had been fitted.

Engine no. 2478 was installed onto the R/H side during the same G-check. According to the engine's logbook, it was installed on 24 April 1997. At the time of installation, the engine had an operating time of 1 947 hours since overhaul. The engine had previously been removed from another helicopter (VH-LHS) and no maintenance work of significance had been carried out on the engine during the period up to the time of installation LN-OPG. Main Task 72-3 was used during installation of the engine, and a signature has been entered confirming that the O-ring had been fitted on the R/H input pinion on the main gearbox. When vibration measurements were carried out on the Bendix shaft after installation, the vibration level was measured at 0.15 IPS. Maximum value is 0.65 IPS. An example of Main Task 72 (72-3) is provided in Appendix C.

1.6.6.4 *Changing Bendix shaft*

According to HS work order no. 9702403, the Bendix shaft with part no. 19E226-8A, serial no. 1796U, underwent a 1 200-hour inspection at a total operating time of 975 hours. (This shaft was later fitted onto the R/H side of LN-OPG). The work order shows that the work was carried out in accordance with MET 63.10.00.601 BENDIX coupling shaft: Checking 19E226-5A/6A/7A/8A. This maintenance instruction refers to Work Card 63.10.00.701 "ENGINE - MGB COUPLING Replacement of coupling shaft splined flange" paragraph 3.2 with regard to the inspection of splines (see subparagraph 1.18.1.1 for supplementary information regarding the MET and Work Card):

"3.2 Checks

- a) If required, check dimensions as per W.C 63.10.00.726.
- b) Perform the following particular checks on the splined flange:
 - Examine diameter D and the mating face:
 - if fretting corrosion is evidenced, clean with Scotchbrite and, if required, blend out locally, using grit 400 abrasive paper: maximum blending depth: 0.03 mm,
 - spray a thin film of molycote G rapide or similar product.
 - Examine diameter C:
 - check for step-like wear of more than 0.03 mm,
 - ensure that 1x 45° chamfer is present on the six 6 mm dia. holes

(if the chamfer is not present, bring the flange to the desired standard before re-assembly)."

The work order documents the fact that dimensions D and C had been measured. However, it does not contain any information regarding whether splines had been measured in accordance with W.C. 63.10.00.726. Work Card 63.10.00.701 does not contain any requirements for inspection of cracks or fretting in the spline area on the splined flange. The part was given Release to service on 2 April 1997. In the maintenance documentation, the Bendix shaft was treated as a unit with regard to flying hours and maintenance. However, the splined flange does not have its own serial number, and can be disassembled and replaced, making it possible for the part to have a different operating time in relation to the Bendix shaft. However, when asked by the AAIB/N, HS stated that the splined flange was not normally replaced, but followed the Bendix shaft routine.

Because of the operating time limitations, the R/H Bendix shaft on LN-OPG was removed in the evening/night of 16 July 1997 and the shaft, previously discussed, with serial number 1796U was fitted (383 flying hours prior to the accident). The work was carried out at the HS base in Brønnøysund. At this time, the base was being established and the need for technicians was covered by short-term placements of aircraft technicians from other bases within the company. The work in question was carried out by two aircraft technicians licensed for this aircraft type, of whom one had begun to act as technical supervisor at the base a short time previously (hereinafter called the technical supervisor). The shaft, complete with assembled splined flange was sent to the base prior to the work being started. No new O-ring accompanied this, since this would normally be installed on the splined sleeve and would not be replaced. It was confirmed that neither MET 63.10.00.401 "ENGINE-TO-MGB COUPLING, BENDIX Coupling Shaft: Removal/installation" or MET 71.00.00.401 "POWER PLANT Engine - Disengagement Removal – Installation" (see Appendix B) listed the O-ring among the "Routine replacement parts."

The work was implemented in accordance with Work specification no. OPG 01399/97 which refers to MET 63.10.00.401. For assistance during the disassembly and re-assembly of the engine, "Main Task no. 72-03 Engine removal – installation" was used (see subparagraph 1.18.1.1 for supplementary information regarding Work specification). The work was started with the R/H engine being disconnected and hoisted down for disassembling the exhaust pipe. According to information provided by the two people involved, the technicians found that the O-ring (part number MS 9388-133) on the R/H splined sleeve on the main gearbox was missing. The technical supervisor was of the opinion that this was normal, since he had seen, on several occasions, that this had not been installed. MET 63.10.00.401 did not mention the installation of the said O-ring either. In addition, the part was not available at the base and could not be procured until the next day at the earliest. This could have led to a considerable delay in the work. The engine was installed without the O-ring on the splined sleeve.

Main Task no. 72, Subtask 479-03, Item 5 described the following:

"Spray an even film of Mollicote G Rapid+ on Sleeves. Install O-Ring, P/N MS 9388-133 on Sleeve, if removed"

This item was signed as executed even though the O-ring had not been fitted. The work of replacing the Bendix shaft was concluded with a vibration run of the shaft. The result was noted as 0.25 IPS. After the work was completed, the aircraft technician checked the helicopter's Illustrated Parts Catalogue (IPC). This confirmed that the O-ring should have been installed. Since doubts had nevertheless been raised regarding the justification for the O-ring, he phoned a colleague the next morning at the base at Sola and gained further confirmation that it should be present. He then informed the technical supervisor about this and then travelled home from Brønnøysund since he had finished a 14-day work period. No further measures were begun for fitting the missing O-ring, and the deficiency was not entered into the aircraft's Daily Maintenance Record (DMR) for further follow-up.

The technical supervisor at the base worked as an aircraft technician on Super Puma helicopters in another helicopter company before being employed at HS. After the accident, he explained to the AAIB/N that he was sure that during that period, the O-ring should not be fitted to the splined sleeve. With reference to the term of employment in the other company, he also explained that he was used to working exactly according to the helicopter manufacturer's MET, and that he did not use Main Tasks at HS unless it was necessary.

Maintenance records from work carried out on the Bendix shaft that was disassembled, indicates that there was no abnormal wear on the associated splined flange.

1.6.6.5 *Fracture in the tie-bolt*

Because of a general problem on this helicopter type, with several cases of fractures on the bolts that attach the liaison tube to the MGB (tie-bolts, see fig. 6), it was decided at HS that these should be checked during each Pre Flight Check (PFC). A fractured tie-bolt (item mod. 07.52316) was found on LN-OPG during such an inspection on 3 August 1997 (255 flying hours prior to the accident). As a consequence of this, the tightening torque for the two other bolts was checked. This check showed that the tightening torque was too high and the two remaining bolts were also replaced.

Representatives of ECF have explained that, from experience, fractures in tie-bolts may be an indication of abnormal loads in the drive train between the engines and the MGB, and that this fracture most probably indicated that something was wrong in that area at this time.

The bolt that had fractured had been stored by HS, and was submitted to the AAIB/N after the accident and sent to Det Norske Veritas (DNV) for metallurgical examination. The result of the examination is given under subparagraph 1.16.4.5.

The aircraft technicians at HS believe that the torque check that was carried out on the bolts on 3 August 1997 is of little value. This is explained by the fact that the bolts were fitted using oil on the threads and then tightened using the correct torque. After even a short period of flying, the film of oil will disappear because of loads and heat, and as a result the friction increases and thereby also the torque that emerges in the check. On the part of the company, a further explanation was given that tie-bolt fracture due to an excessively high tightening torque was common during one period. This was explained by the fact that the MET was not revised at the time of the introduction of a modified tie-bolt that required a lower tightening torque when installed (see Appendix B, fig. 2).

1.6.6.6 *Inspection of the coupling between the Bendix shaft and the main gearbox (MGB)*

The coupling between the Bendix shaft and the main gearbox should be inspected every 500 flying hours. On this basis, an inspection was ordered for both the R/H and L/H sides of the main gearbox. For the R/H side, the company's "Work Pack, Work Specification" was described as follows:

"REMOVAL OF RIGHT ENGINE

1. Remove Right Engine iaw MET 71.00.00.401
Doc. ref: MET 71.00.00.401

NDT OF RIGHT MGB INPUT SLEEVE

2. Perform NDT of Right MGB Input Sleeve iaw MET 63.10.00.602, para. 3.4. Doc. ref: MET 63.10.000.602

INSTALLATION OF RIGHT ENGINE

3. Install Right Engine iaw MET 71.00.00.401
Doc. ref: MET 71.00.00.401"

MET 63.10.00.602 is reproduced in Appendix A. On the basis of this "work order", a Non Destructive Testing (NDT) engineer was sent from Sola to Brønnøysund on the morning of 21 August 1997. The engineer had been working within the company for 17 years exclusively with NDT and, one year earlier, had completed training to Level II in five NDT methods at the International School of Aerospace in Norwich, England.

The helicopter arrived at the base on 22 August at 0130 hours and the preparations for the inspection were begun (121 flying hours prior to the accident). An aircraft engineer from the base released and pushed the engines forward with the assistance of the NDT engineer. This work was carried out in accordance with MET 71.00.00.401 "POWER PLANT Engine - Disengagement Removal-Installation." This document contains the following sentence regarding the marking of the splined flange and splined sleeve:

- "2.1 During this uncoupling operation, mark the respective angular positions of both the splined flange and sleeve."

The aircraft technician who carried out the work confirmed that this item was carried out. The NDT engineer then carried out a dye penetrant inspection of the R/H and L/H splined sleeves while these were attached to the main gearbox. The NDT inspection was carried out in accordance with the prescribed standard procedure, WC 20.02.09.101. The NDT engineer found no cracks and he finished by signing the Work Pack, Work Specification adjacent to the paragraph "NDT OF RIGHT MGB INPUT SLEEVE." The NDT engineer was not familiar with the practical use of the reference document, MET 63.10.00.602, because he did not make use of this in his day-to-day work in the workshop. He therefore used the document only as a description of the areas that should be inspected. In his opinion, there was nothing in the wording of the Work Specification to indicate that any of the work had been omitted. In conversation with the AAIB/N, he stressed that he had adhered to the established standards for the dye penetrant inspection and that it was exclusively that work that he had signed for. He carried out only an NDT inspection of the splined sleeve and did not carry out any other tasks in conjunction with this work, such as removing O-rings, for example. It was only after the accident that he became aware that there should have been an O-ring on the splined sleeve. He further expressed that he would notify an aircraft technician if he discovered a fault in that part.

Another aircraft technician, who began his shift that night, carried out the subsequent installation of the engines, together with the first aircraft technician. This work was also carried out in accordance with MET 71.00.00.401 "POWER PLANT Engine - Disengagement Removal-Installation" (see Appendix B). This document contains no details about the O-ring having to be fitted onto the splined sleeve. The following text refers to checking the Bendix shaft prior to installation:

"CAUTION: BEFORE INSTALLATION, CHECK THAT THE BENDIX COUPLING SHAFT IS CLEAN."

HS has drawn up a system that caters for amendments and additions to the MET of the helicopter manufacturer. This is done by inserting its own pages marked "HS REVISION" in between the pages in the MET. Such an amendment has been inserted beside page 1 in MET 71.00.00.401. The following quotations are taken from this:

"Engine removal - installation procedure.

A Main Task 72, Engine removal - installation is located in MRM chapter 2, ATA 71."

Main Task 72 contains a detailed description of the installation of an engine. Subtask 479-03, item 5, in this document reads:

"Spray an even film of Molicote G Rapid+ on Sleeves. Install O-Ring, P/N MS 9388-133 on Sleeve, if removed"

According to the two aircraft technicians who installed the engines, Main Task 72-3 was not used. The explanation for this was that the Main Task 72 was meant for removal of the engine, and not like in this case, a partly disconnection. Further, the

Main Task 72 was not mentioned in the Work Specification. They have explained that the splined flange was not subjected to anything more than a general inspection prior to installing the engines, and that the presence of the O-ring was not checked. In addition, the mandatory Sleeve Concentricity Check was not carried out. A vibration check was carried out after the engines had been installed. The measurement values from the check were not documented since there was no heading for this in the Work Specification. However, the aircraft technicians have provided information that the values were well below the limit value of 0.65 IPS. On the other hand, Main Task 72-3, which was not used, contained a specific heading under which the results of the vibration check should be entered. In accordance with the company's procedures, a double signature was required against the heading for the inspection as a whole (including removal and installation of the engines). Under this heading, the NDT engineer entered a signature erroneously, confirming performance of the entire work, and one of the aircraft technicians entered a signature as controller. The work was completed before the helicopter was to start its regular flight at 0600 hours on the morning of 22 August 1997. According to the people involved, the work was carried out without pressure of time.

1.6.6.7 *Maintenance work and inspections carried out on LN-OPG after the inspection of the coupling between the Bendix shaft and the main gearbox (MGB)*

No discrepancy reports on the LN-OPG were written during the period between 22 August 1997 and the time of the accident.

A list "Printouts of Complaints" shows that a total of 10 observations were entered during the same period. With only one exception, these observations were acted upon prior to the accident occurring. Common to all of these observations is the fact that they did not have any effect on the course of events.

LN-OPG arrived at the base in Brønnøysund on 7 September 1997 at 2046 hours. The last Daily Maintenance Check (DMC) was completed and signed off at 2340 hours that same day. The Daily Maintenance Record (DMR) shows that the helicopter had an open remark regarding the fact that there was a crack in one cabin window. The Pre Flight Check (PFC) prior to departure on 8 September was carried out inside the hangar. The work was carried out without pressure of time and without any discrepancies being entered. By mistake, no signature was entered in the DMR for performance of the PFC and neither was this noticed by the crew.

1.6.7 Supplementary information regarding the power transmission between the engine and the gearbox

1.6.7.1 *History - modifications of the power transmission between the engine and main gearbox*

According to ECF, the power transmission between the engine and the main gearbox was designed for the AS 332 which first flew in 1978. At this time, the splines between the gearbox and the Bendix shaft were lubricated with lubricating grease. To prevent the grease escaping from the splines area, the splined sleeve had a type MS 9388-133

O-ring mounted in a groove. When a number of problems appeared to be occurring in this area, a series of modifications were undertaken during the period up to the accident. The following items of interest are mentioned:

- December 1982: Clearance between the cylindrical section of the splined sleeve and the splined flange was increased and given a minimum of 0.1 mm with a lock washer installed. This was intended to prevent fretting in this area.
- April 1985: SB 63.15 (Mandatory) Change from lubricating grease to dry lubrication (Molycote G rapid +) on the splined sleeve. This was done to prevent the grease getting into the bellows on the Bendix shaft and thereby possibly creating an imbalance. Instruction that the O-ring should be removed.
- April 1985: SB 63.16 (Optional) Reduction in the thickness of the silver coating on the lock washer such that the loads on the splined sleeve during installation of the lock washer would be reduced.
- January 1986: SB 63.21 (Mandatory) Order regarding reinstallation of the O-ring. Other orders covered by this SB are concerned with inspection of the splined sleeve for fretting, dimension checking, dye penetrant inspection of the splined sleeve and checking of the tightening torque on the tie-bolts.
- July 1986: First amendment of SB 63.21 (Mandatory) Introduction of a vibration check after replacement of a Bendix shaft.
- June 1987: Second amendment of SB 63.21 (Mandatory) Introduction of a new Bendix shaft with thinner shaft walls. This reduces the mass that could produce imbalance. Introduction of the input pinion out of round check (also called a concentricity check) in order to investigate any potential eccentricity of the input pinion.
- November 1990: New type of splined sleeve introduced. This improves the centering of the coupling.
- Mod. 52318: ECF developed a new method for locking the lock nut to reduce the loads on the splined sleeve. This involves the lock nut having small grooves and slots so that a new type of lock washer can be pushed in to retain the lock nut. The lock washer thus engages in slots milled out of the splined sleeve. This, which in many ways might be designated an inverted solution, is standard on the AS 332L2 which came onto the civil aviation market in 1992 (see fig. 9). This solution, which according to available information has fewer reported problems, can be retrospectively installed on the AS 332L1.

1.6.7.2 *Reported practical experience with the main gearbox (MGB) and power transmission between the engine and the MGB*

ECF has provided information regarding 17 reported cases of problems with power transmission between engine and MGB in the period up to the time of the accident with the LN-OPG. The table below provides a summary of these:

NO.	DATE	CRACK SPLINED SLEEVE	CRACK SPLINED FLANGE	BENDIX SHAFT FAILURE (END)	MGB (SERIAL NO. & SIDE)	COMMENTS
1.00	06/83	x			M134, LH	Fatigue crack on splined sleeve centering diameter.
2.00	06/84			ENG	M130, RH	
3.00	07/84	x			M126	2 fatigue cracks on splined sleeve centering diameter
4.00	12/84	x	x	MGB	M192, LH	45° fatigue cracks on splined sleeve. Fretting on centering diameter
5.00	12/84	x	x	MGB	M130, RH	
SB 63.15 O-RING Removal						
6.00	05/85	x		ENG	M188, LH	
7.00	08/85			ENG	M167, RH	
8.00	08/85	x			M195, LH	LN-OMG, Helikopter Service. O-ring installed. Detected during accomplishment of SB 63.15
9.00	10/85	x	x		M130, RH	45° fatigue cracks on splined sleeve. Fretting on centering diameter
10.00	10/85	x		MGB	M195, LH	Helikopter Service. LN-OMG. Engine overspeed and shut-down during approach to Tender Clipper. Cracks and loose pieces in splined sleeve. Crack pattern similar to LN-OPG. Speed probes (Nf) destroyed. No O-ring
11.00	11/85			ENG	M193, RH	
12.00	11/85			MGB	M176, LH	Splined sleeve out of round
13.00	12/85			ENG	M135, RH	
SB 63.21 O-RING Installed						
14.00	10/86	x	x	ENG	M134, LH	
15.00	02/87			ENG	RH	
16.00	08/87			MGB	M187, RH	Splined sleeve out of round. Fretting on splined sleeve centering diameter
17.00	01/88			MGB	RH	

The bold text shows gearboxes and their respective R/H and L/H pinions that have been involved in several incidents. This shows that 3 pinions have been involved in 7 cases.

In addition to the incidents listed in the table, the AAIB/N is familiar with the following five incidents:

- Non-conformance report no. AS332-63-10-01 dated 16 August 1985 describes a case at HS of the Bendix shaft remaining stuck on the MGB during removal of an engine. A more detailed investigation revealed that the splined sleeve had cracked because of too small tolerances between the lock washer/circlip and the splined sleeve.
- On 16 June 1998, an AS 332M1 helicopter belonging to the Swedish Army had problems on departure. During hover, the crew heard abnormal sounds from the engine area and the mission was terminated. Subsequent vibration measurements of engine no. 1 showed 40 mm/s (1.73 IPS), which was well outside the permissible limits, and it was decided to disconnect and rotate the Bendix shaft. During disassembly of this, it became clear that the splined flange had cracked and was split into five main sections. A total of around 20 crack initiations/cracks were found. All of the cracks were caused by fatigue. The splined sleeve had deep traces of wear along its active surfaces and 1/3 of one spline had come loose. The O-ring on the splined sleeve was in place. A lot of fretting products had been found but little lubricant in the splines. The Bendix shaft, engine and main gearbox were sent to ECF for more detailed examinations. There, it was established that all speed probes (Nf) had wear damage after contact with the phonic wheels. The engine, the Bendix shaft and the splined flange had accumulated 1 827 flying hours at the time of the incident. The main gearbox had been overhauled 642 flying hours prior to the incident. It had been repaired by the same company as that which undertook the overhaul, 409 flying hours after that work due to problems with a reduction gear. The same problem led to the repair having to be repeated 75 flying hours later. At this time, it was established that the splined sleeve had damage and wear, and this was therefore replaced (158 flying hours prior to the event). ECF has not come up with any conclusion as to what was the cause of this incident. However, one possible theory is based on the damaged/worn splined sleeve having damaged the splined flange in such a way that fatigue cracks developed in the period after the splined sleeve had been replaced.
- On 6 September 1998, during an inspection of an AS 332L1 in the USA, it was discovered that the lock washer had come loose and moved forward in relation to the splined sleeve. Nevertheless, it was not possible to pull out the lock washer in the normal way, and it had to be cut in two pieces before it was removed. Examinations showed that the circlip was not lying in its original groove in the lock washer and that it had created several deep grooves in the lock washer, as the lock washer had been moving axially forward in relation to the splined sleeve. The pattern of damage indicated that the circlip had been lying in the groove in the splined sleeve during this entire process. The lock washer had moved axially right up to it and the locking nut came out of engagement. Then, the lock washer had rotated in relation to the splined sleeve so that the micro splines on both the lock washer and the splined sleeve were badly damaged and completely worn away in places. The circlip had clear wear marks, but was otherwise

complete. These findings are described in the report Failure Analysis, Main Gear Box Input Components, AS332L1 Super Puma N171EH, ERA Aviation inc. published by R.J. Waldron & Company (1987) LTD. The report establishes the fact that the main gearbox had been operating for 13.3 hours since the last vibration check was carried out. This check showed a vibration level of 0.07 IPS. In addition, the operating time for the gearbox was 29.8 hours since the last visual inspection of the area. The operating time for the gearbox since its last overhaul was 930.6 hours. The report concludes that no production faults were found on the components, and no traces indicating that the lock washer had been incorrectly installed, or anything that indicated any failure in maintenance. No faults were found internally in the MGB, and this was made airworthy once again after replacement of components in the shaft input. During examinations of the engine concerned, it was established that a tie-bolt in the compressor section was "loose" without any conclusions having been drawn regarding the causal relationship.

- MGB no. M136 was overhauled by HS and was installed in G-PUMA on 15 February 1999. 77 flying hours later, a warning was received from IHUMS that the signals (peak to peak) from the accelerometer beside the R/H input pinion were so powerful that they could not be processed by the system (up to 1 000 g). The gearbox was removed and sent to HS for inspection, in accordance with overhaul instructions, without any fault being found. In consultation with ECF, the gearbox was once more approved for flying and was returned to the operator, this time for installation in G-PUME. After installation, it was established that the signals were still at a high level (600 g) and when they again began to increase, the gearbox was removed after 15 flying hours and returned to HS. The gearbox was then bench tested with vibration data from the R/H and L/H input pinions and the rear R/H torquemeter shaft were recorded on a Brüel & Kjær (B & K) vibration recorder 7007. These were analysed using a B & K dual channel FFT analyser model 2032. The analysis showed that signals equivalent to the 38th harmonic of the rotation RPM on the 8 000 RPM wheel/torquemeter shaft dominated the frequency spectre recorded by the accelerometer beside the R/H input pinion. The R/H and L/H torquemeter shafts being interchanged did not affect this image. By interchanging the input pinion/8 000 RPM wheel combination in a similar way, the marked frequency image moved over to the L/H side (see also subparagraph 1.19.2). The combination of input pinion/8 000 RPM wheel, which was originally on the R/H side, was replaced with new components. This led to the vibration level dropping to a normal level. The two relevant parts were assessed by HS as adhering to the requirements specified in the overhaul instruction. However, during an assessment at ECF, it was found that the input pinion was worn outside the tolerances, and that considerable wear on the 8 000 RPM wheel (serial no. M 624) was under assessment in April 2000 without any conclusion being drawn. After this, HS concluded that the overhaul

instruction supplied by ECF is not sufficient with regard to inspection criteria for teeth on gears.

- In September 1999, there were reports of differences between Ng 1 and Ng 2 on an AS 332 with serial no. 2097 in Japan. It was decided to run the engines on the ground. During shutdown, noise was heard to come from the area around the L/H engine. On inspection, it was discovered that a piece of one tooth from the L/H splined sleeve had come loose. In another area, there was more damage to a tooth, and a crack was discovered which went right out to the front edge of the cylindrical part of the splined sleeve. This crack is very similar to one of the cracks on the splined sleeve from LN-OPG. Considerable wear was found on several teeth on the splined sleeve and, in particular, the splined flange, with no trace of any lubricant. In addition, it was established that there were cracks in the L/H power turbine rear support and traces of contact between the speed sensors and the phonic wheels. The helicopter had accumulated 254 flying hours since the last inspection of the coupling between the Bendix shaft and the MGB. During the last 89 flying hours prior to the incident, the helicopter had been carrying out logging activities; in other words transporting suspended timber. Because of wiring being replaced to the speed probes, the L/H engine had been uncoupled from the MGB 66 and 33 flying hours prior to the incident. On the last occasion, it was established that the splined sleeve was worn, but by mistake this was not replaced. The last vibration check was carried out 4 flying hours prior to the incident, but it proved that the value of 0.03 IPS was worthless because the attachment bracket for the accelerometer was loose. Information given by ECF indicates that the torque on the tie-bolts was insufficient, and that movement between the liaison tube and the MGB might have been a contributing factor. During examinations of the longest crack in the splined sleeve it was found 682 000 striations. Further it was found that the helicopter had started the engines 17 times during the period that the crack existed. From this it was found that the helicopter had accumulated 30.5 flying hours since the crack was initiated. Hence it follows that 385 striations was deposited for every minute. This is the same magnitude as the speed of the main rotor, which is 265 RPM.

1.6.7.3 *Production of a splined sleeve*

Early in the investigation, attention was focused on splined sleeve production. The AAIB/N consequently went into the production and post-processing of the component in detail.

A component can be coated with various types of coating materials. This is done to give the component the desired practical characteristics without the entire component having to be made of the same material as the coating. Simpler, cheaper production is achieved in this way and, in some cases, this is also the only way in which the desired characteristics can be achieved. In this case, the purpose was to have a "ductile" core and a wear-resistant surface. In order to obtain high wear-resistance on the surface,

ECF choose to apply tungsten carbide by means of plasma spraying (see subparagraph 1.18.3).

Ready-machined splined sleeves were measured and checked by ECF before being sent to Praxair in Saint-Etienne (formerly Union Carbide France) for the application of a hardmetal coating. The AAIB/N visited Praxair and had it confirmed that the hardmetal coating has the designation LW-1N40 equivalent to specification CW 15% Co. This is tungsten carbide in a cobalt matrix (Co ~ 15%) applied by means of plasma spraying.

According to information supplied by ECF, the coating should have the following properties:

- Hardness: 1 050 - 1 200 HV0.3 (carbides)
- Porosity: 0.7 - 1.0%
- Adhesion to the base: 100%
- Thickness, tooth surfaces: 25 μm +5 μm
- Thickness, cylindrical section: 70 - 100 μm

Prior to coating, the splined sleeve was blasted with steel grain and cleaned. The coating was applied in two sessions, one for the cylindrical section and one for the tooth surfaces. After spraying, the coating on the cylindrical section was ground down to the correct thickness, while the spline area was manually rubbed down using a scouring pad. The thickness of the coating was then measured and documented prior to visual checking and dispatch to ECF. At ECF, the parts were not given any additional checks prior to being put into service.

Praxair stated that adhesion and hardness were not checked for each individual component. The components were coated in series, in which a test piece was sprayed simultaneously. This was used for quality control of the coating on all of the components in the series. However, the test pieces were not coated using the same angles, speed and thickness as the components. These checks included examinations for hardness, oxide content and non-metallic inclusions.

ECF had selected the coating and the relevant process on the basis of good practical experience of using the same coating on other components in other helicopters. The AAIB/N gained the impression that the design and loads linked to the splined sleeve had had little influence over the choice of coating type. Consequently, no requirements for grain size were specified even though the coating, at its thinnest, could be only 20 μm thick. Furthermore, the AAIB/N gained the impression that ECF had not investigated whether other procedures and coatings would have been more suitable. According to ECF, the quality assurance of the work at Praxair had been taken care of by annual audits of the company.

According to the documentation from Union Carbide France, the R/H splined sleeve from LN-OPG had a hardmetal coating applied in October 1989. The part was one of 43 splined sleeves in a series. Documentation of the spraying process does not allow

any traceability of the individual components in the series. The R/H splined sleeve from LN-OPG was marked with the following:

332 A32 2288 22 BUSA 6 < SFA/V107 Rep 2

ECF has stated that Rep 2 originates from minor damage on the front end of the cylindrical section. The damage was detected and fixed by ECF prior to the hardmetal coating being applied.

1.6.7.4 *Components loaded with high torque/torque variations*

MET 05.99.00.P8 paragraph 7 (Airworthiness limitations) provides a list of components that should be given special attention during helicopter operations involving Frequent torque variations. Some of these are listed below:

- The main MGB module
- The Bendix Engine-to-MGB coupling shaft

MET 05.53.00.602 provides an overview of the inspections and the work that should be carried out in the event of various levels of overtorque. The MGB and Bendix coupling shaft are also discussed in this context.

1.6.8 Supplementary information about the main gearbox (MGB)

In the experience of ECF, input pinions had been found with tooth surfaces that were rougher than was specified. These had nevertheless been installed in gearboxes because of deficiencies in production control. Measures were implemented to raise the standard of the input pinions and on 5 January 1998, HS received amendment no. 12 of AS 332 MRV (the Overhaul Manual). This included an order regarding the checking of all "pinions front 332A32-2145", to verify whether they had serial numbers lower or higher than 1644. All input pinions with serial numbers lower than 1644 were to be sent to ECF for correction of the teeth surfaces (lapping of the teeth on "FASSLER"). After modification, the part was to be marked with an R. After the accident, however, ECF found several 8 000 RPM wheels with considerable wear on the teeth. Relatively rough surfaces were also found on the teeth of the input pinions that belonged to these. ECF is therefore of the opinion that there is a link between rough surfaces on the teeth on the input pinions and abnormal wear on the teeth on associated 8 000 RPM wheels. This has led to ECF putting into effect a procedure to further improve input pinions, a part of which includes nitride hardening of the tooth surfaces.

1.6.9 Supplementary information regarding the engine's RPM control and indication

1.6.9.1 *Training and understanding of Overspeed Safety Protection*

The AAIB/N has taken a more detailed look at the company's training of pilots with regard to engine regulation and indication.

A starting point for pilot training at HS is the manufacturer's Super Puma Instruction Manual. Section 14.12 discusses Free Turbine Overspeed, Safety System Controls and Displays (see Appendix D). This section contains a description of the way in which the engine automatically stops and prevents "overspeed" in the event of a fracture in the Bendix shaft. According to this description, the OVSP light can only indicate with a flashing light once the engine has reached an RPM of more than 25% of Nf. When the diagram on page 14.33 of the textbook is studied, it appears that both of the Nf sensors must record a speed of 120% or more to stop the engine automatically. In the event of an automatic stop, however, first the warning lights "DIFF. NG", "ENG. P" and "ALARM" will light up on the Failure Warning panel and then more lights will gradually come on as the engine stops. In that case, OVSP will only provide supplementary information about why the engine stopped.

The Approved Flight Manual including checklists gives no other relevant information for training and understanding of the system.

The pilots at HS were of the opinion that the OVSP light could only be constantly lit if the Nf was below 25%. A flashing OVSP light informed that the overspeed protection had engaged and that the engine had stopped. They were unaware of the condition that both of the sensors had to register more than 120% Nf for the system to actuate.

The OVSP light is only mentioned once in the helicopter Emergency Checklist and then in a situation in which it flashes. This is the only situation that involves the OVSP light and on which the company provides training in the simulator.

1.6.9.2 *Reported cases of malfunction*

The reported cases at HS in which the GOV or OVSP lights have come on due to failures in the engine control system or the system for RPM regulation:

- In HS Flight report AS 332-72-1, there is a description of an aborted flight on 16 January 1984 (LN-OMF). 20 min. after departure, a rumbling noise was heard coming from the engine area. A few minutes later, the GOV No. 1 light came on. It was decided to return, but on the way back, the OVSP No. 1 light came on. The engine was stopped after it was established that oil pressure was decreasing. Investigations undertaken after the incident showed that bearing no. 5 on the L/H engine had broken down. In addition, it was established that there were fret marks on the phonic wheel and speed sensors. A speed sensor (for RPM regulation) had been subject to such major damage that it was unserviceable.
- In the Technical Report Form for Irregularities and Malfunction No. AS 332-73-3 [Teknisk rapportskjema for uregelmessigheter og feilfunksjon] from HS, dated 10 August 1984, includes details of a case when the GOV light led to the cancellation of a flight. It was established that there was an electrical discontinuity in the Nf harness and this was mentioned as a known problem.

1.6.9.3 *Corrective measures*

On the basis of the information that emerged during playback of the CVR from LN-OPG, Turbomeca immediately ordered (via a Fax Alert) all operators of Makila engines to stop the engine concerned if the OVSP light came on while airborne. As a result of this, helicopters belonging to HS returned to base on one engine on 20 October and 12 December 1997, respectively. The AAIB/N has been informed that both of these cases were resolved to be due to a failure in the indicating system.

On the basis of the accident, Turbomeca has undertaken considerable amendments in the EECU for the 1A1 engine. The modified EECU (standard TU 203) has been taken into service at HS in the year 2000, and this has led to further changes in the procedures that should be implemented if the OVSP light comes on while airborne.

The AS 332L2 has an OVSP light located in the middle of the instrument panel. In this way, it is easier to monitor the indication light than when it is located down on Sub-panel 34.

1.7 **Meteorological information**

1.7.1 The AAIB/N received the following reports from the Forecasting Division for Northern Norway [Værvarslinga for Nord Norge]:

IGA 03 UTC, METAR 03 - 06 UTC, TAF 03 - 09 UTC and analysed maps 03 and 06 UTC. (The maps have not been included in the report - AAIB/N note.)

1.7.1.1 The general situation at 0300 hours UTC: A low pressure centre of 979 hPa with its centre at 70°N 05° E was moving slowly in a south-easterly direction. A frontal zone had passed the Brønnøysund area at around 2200 - 2300 hours UTC on 7 September. After it had passed over, there were scattered showers in the area. At the end of the period, TCU/CB began to develop.

Weather:	Scattered rain showers
Visibility:	Mainly + 10 km, temporary 5 - 10 km in rain
Surface wind:	On the coast: SW - W / 10 - 15 kt Over the sea, west of Brønnøysund: SW / 20 - 25 kt, temporary 30 kt
3 000 ft wind:	SW / 20 - 30 kt
5 000 ft wind:	SW / 25 - 35 kt
Clouds:	Scattered clouds at 1 000 - 1 500 ft Broken clouds cover at 2 000 - 2 500 ft At the end of the period, development of TCU/CB
- 10 °C level:	FL 120 - FL 130
Freezing level:	FL 060 - FL 070
Icing conditions:	Temporary light to moderate in conjunction with convective clouds

Turbulence: Temporary light to moderate in conjunction with convective clouds
Estimated QNH: 984 - 986 hPa, lowest in the western areas.

1.7.1.2 IGA PROG VALID 080300-081200 UTC ENBD FIR

PART 1: NORDLAND AND TROMS COASTAL AND FJORD DISTRICTS,
VALLEYS AROUND BARDUFOSS

WIND SFC-2000FT SW-SE/10-20KT, BECMG MAINLY SW
WIND FL070 180-240/20-40KT STRONGEST COT S-PART FST HRS
WX RA/RADZ, BECMG SHRA S-PART
LOC FG N-PART EARLY
VIS LOC 4-8KM IN DZ. 0.3-1KM IN FG. ELSE + 10KM
CLD SCT/BKN 2000-5000. VV 0200-0500 FT IN FG
FEW/SCT TCU/CB 1500FT S-PART LATE
O-ISOTHERM FL050-070
ICE LOC FBL/MOD
TURB LOC MOD/FBL NORDLAND, ELSE FBL/NIL

1.7.1.3 TAF issued 072300 UTC for Monday 8 September 1997:

ENBN 080006 16015KT 9999 -RA SCT015 BKN030 PROB40 TEMPO 0006
4000 RADZ SCT008 BKN015 BECMG 0204 22020G30KT=

1.7.1.4 TAF issued 080200 UTC for Monday 8 September 1997:

ENBN 080309 24015KT 9999 -SHRA SCT015 BKN025=

1.7.1.5 METAR

ENBN 080350Z 26010KT 9999 RA SCT010 BKN020 11/10 Q0990=
ENBN 080450Z 23007KT 9999 RA SCT010 BKN020 12/11 Q0989=

1.7.2 Weather report for the Heidrun oil field on 8 September 1997 at 0500 hours local time:

WIND DIRECTION/SPEED 255°/34
VISIBILITY +10, 4 - 6 IN SHOWERS
WEATHER SHOWERS
CLOUDS - BASE BKN/1200FT BKN/4000FT
TEMP./DEWPOINT 11.3 °C / 8.5 °C
QNH 987

1.7.3 Weather report for HB: 451 (AAIB/N Note: HKS 451) from TRANSOCEAN PROSPECT

DATE	08.09.97	TIME: 0500
WIND DIRECTION	250°	WIND SPEED: 20 KNOTS
VISIBILITY	8 KM	
CLOUD COVER	8/8	SOME SHOWERS ALTITUDE 1200 FT
TEMPERATURE	11.8	QNH 986 hPa
NORNE	ROLL: 0.6, PITCH: 0.7, HEAVE: 2.0	

1.7.4 The following weather report was received by the helicopter crew, sent from Transocean Prospect at 0653 hours:

"The present weather is: Wind 240° at 24 knots - the visibility is about ten kilometres. We have about seven octas of clouds at variable height - the most about one thousand feet, and the QNH is 985".

1.7.5 Wave height and sea temperature were only available from the Heidrun oil field that is located south of the Norne oil field. These details, from the Norwegian Meteorological Institute were intended to apply to the Norne oil field:

Wave height: 3.5 m. Sea temperature: 13.6 °C

1.8 Aids to navigation

1.8.1 LN-OPG was equipped with a navigation system of the RACAL RNAV 2 type. This system used signals from the VHF Omnidirectional Radio Range (VOR) in combination with Distance Measuring Equipment (DME), Non Directional Radio Beacon (NDB) and Global Positioning System (GPS). In addition, radar could be used for locating landing sites.

1.8.2 After departure, LN-OPG flew towards the HELIK reporting point (radial 270°M, DME 15 NM from ENBN), which applies to all 6 routes to the Heidrun and Norne oil fields. From HELIK, the aircraft followed route TANGO (300°M) up to TANGO 90 and, further, straight towards the Norne (see fig. 1).

1.8.3 No navigation aids in the area were reported to be out of service at the time of the accident involving LN-OPG.

1.9 Communications

- 1.9.1 The crew was in radio contact with Brønnøysund AFIS on a frequency of 119.6 MHz on start-up at 0548 hours, during departure at 0600 hours and during the subsequent outgoing flight. At 0614 hours, radio contact was established with Bodø Air Traffic Control Center (ATCC) on a frequency of 126.3 MHz. Bodø ATCC then reported that they had radar contact with the aircraft. Bodø ATCC was informed that the estimated time of arrival at TANGO 30 was 0619 hours and arrival on the Norne was at 0706 hours. All radio communication from LN-OPG was undertaken by the co-pilot.
- 1.9.2 At 0654 hours, Bodø was informed that contact had been established with the Norne and that HKS 451 was in the process of starting its descent. HKS 451 was requested to report to Bodø when "on deck", at the same time as the information was given about radar service terminating. The co-pilot confirmed that they would report "on deck". This was the last communication with Bodø ATCC.
- 1.9.3 Normal communication with the radio station on the Transocean Prospect was established at 0652 hours. The weather conditions for landing on the Norne and traffic information were given.
- 1.9.4 No abnormal conditions were reported in the radio communication between the aircraft and the units for the Air Traffic Control Service or the radio operators on the oil installations.
- 1.9.5 After the aircraft went out of control, the co-pilot attempted to send the emergency signal MAYDAY. According to the CVR, this occurred at 06:56:43 hours. This call was not transmitted from the helicopter. It has not been possible to ascertain whether this was due to the transmitter not having been activated, or the radio having ceased to function at this time.
- 1.9.6 The aircraft was equipped with an externally mounted Emergency Locator Transmitter of the ADELTA type. No signal from this transmitter was ever received.

1.10 Aerodrome information

LN-OPG was en route towards the helideck on the oil production vessel, Norne, and was out of range of radar cover when the accident occurred. The helicopter had then established radio contact with the oil rig, Transocean Prospect.

1.11 Flight recorders

1.11.1 Introduction

- 1.11.1.1 In accordance with the Norwegian Regulations for Civil Aviation, BSL D 1-12, helicopters certified in accordance with the requirements for transport category A in

compliance with US FAR PART 29 should be equipped with voice recorders approved by the NCAA. Installation of a voice recorder on LN-OPG was therefore a mandatory aviation requirement. Installation of a flight recorder, on the other hand, is not mandatory.

- 1.11.1.2 LN-OPG was equipped with a Flight Data Recorder (FDR), a Cockpit Voice Recorder (CVR) and a monitoring system for technical status (Health and Usage Monitoring System - HUMS). The installation in LN-OPG is called IHUMS (Integrated Health and Usage Monitoring System) because HUMS has been integrated with the system for CVR and FDR. This means that CVR and FDR have been combined in a Combined Voice and Flight Data Recorder (CVFDR) by Penny & Giles, type 900/D51506. Recordings are stored on magnetic tape. The CVFDR was equipped with a Dukane DK 100 acoustic transmitter (pinger). This transmitter was absolutely crucial in locating the helicopter on the seabed.
- 1.11.1.3 The CVFDR was mounted in the tail boom just behind Frame Station 9000. It was torn out during the crash and was found beside the main wreckage partially submerged in the mud. The difficult working conditions down on the seabed and the priority of retrieving the bodies of the casualties led to the recorder sinking right down into the mud. For a time, therefore, it was feared that it had completely disappeared. Thanks to the proficiency of the ROV operators, however, the undamaged recorder was located once more and then salvaged.
- 1.11.1.4 After the CVFDR had been salvaged, it was taken to the Air Accidents Investigation Branch (AAIB) at Farnborough in England for playback and copying in collaboration with the AAIB/N. The information from the CVFDR was regarded as being so important that a dedicated working group was appointed to gather and coordinate all available resources. This consisted of representatives of the AAIB, the French Bureau Enquêtes Accidents (BEA), ECF, Turbomeca, HS and the AAIB/N. The results of this work were collected in a report drawn up at a meeting on 9 and 10 December 1997, and the following information is based on this report.

1.11.2 Information from the CVFDR

- 1.11.2.1 Despite the loads to which the component had been subject, all relevant information was available. The CVR stores information from three channels: sounds recorded from the microphones of the pilot-in-command and the co-pilot, respectively, and one microphone that picks up sounds from the cockpit area. The acoustic frequency spectrum discussed below have emerged after analyses of sounds from the cockpit's area microphone. To simplify time indications, the time for the sound of the fracture of the Bendix shaft has been given the designation T (Thud). T is timed at 06:56:30 hours, a time that coincides with a flying time of 56 mins. and 30 secs. In this chapter, "-" should be regarded as a minus in connection with time indications. The digits 1 and 2 designate the L/H and R/H engine, respectively. Below is a list of relevant information from the CVR and FDR point-by-point in a chronological order.

- The Bendix shaft produces a 384 Hz acoustic base frequency during normal operations. The shaft can also produce harmonic overtones of approx. 768 Hz and 1152 Hz etc. (see fig. 10). Analyses of the acoustic frequency spectrum from the CVR shows that the content of overtones began to change markedly in the period at T - 7 min.
- At T - 6:23 mins., the crew was aware of an abnormal observation and this was commented as follows (P = pilot-in-command, CP = co-pilot, TP = Transocean Prospect, B = Bodø, tx = transmission via radio):
 - T - 6:23 P well, that was an strange light
 - T - 6:14 CP what light are you thinking of --- was there something I didn't quite catch here?
 - T - 5:55 CP yes
 - T - 5:46 CP OK, yes

At that time (T - 5:30), the Nf 2 signal, recorded by the FDR, began to change in that irregular low values were being recorded. This tendency increased towards the time of the accident (see fig. 11). The engine also recorded sinking values of Nf 2 signals, which led to a slight increase in recorded Ng 2 and an increase of just under 10 °C in T4 2. The crew continued to discuss the observations, as follows:

- T - 5:17 P it was engine two overspeed that was on
- T - 5:16 CP overspeed yes it is the governor
- T - 5:13 P no, it was the overspeed
- T - 5:11 CP it was *that* last, now there's this one too
- T - 5:09 P no, it was
- T - 5:09 CP was it that - OK
- T - 5:09 P yes
- T - 4:28 P yes we've never actually had exactly this kind of malfunction before
- T - 4:25 CP no, neither have I
- T - 4:22 CP action continue flight on one engine – engine malfunction in flight
- T - 4:16 CP but it seems as if there was something - it keeps coming and going
- T - 4:01 Sound "beep" (change of frequency)
- During the period, T - 3:49 to T-2:52, the crew established contact with the Transocean Prospect and exchange details of the number of passengers and the local weather conditions. A little later, contact with Bodø was terminated:
- T - 1:48 CP Bodø Helibus 451, we are in contact with Norne – leaving 2 000 and estimate Norne 05 (tx)

- T - 1:38 B Helibus 451, roger, radar service terminated - call on deck (tx)
- T - 1:32 CP call on deck 451 (tx)
- T - 53 CP yes, it's the sensor that's causing the problem
- T - 47 CP what do you think, (the name of the captain)?
- T - 45 P yes, it must be something or other
- T - 35 P Gee, that was really strange
- T P (expression of surprise)

- At T - 1.6 secs, the content of overtones from the Bendix shaft reduced considerably and the recorded Nf 2 signal went back to normal values merging with the values from Nf 1
- At T, the CVR recorded the sound of a thud in the helicopter, followed by a dropping frequency (as if something loses RPM), Tq 2 dropped towards zero and Tq 1 increased. The Nf 2 signal to the FDR went to zero
- During the period T to T + 1.7 secs, Ng 2 dropped to 85% during the course of the first second, then it reached 91%. A spectral analysis of the sound from the cockpit shows that, during the same period, Nf 2 increased from 100% to 175% (see figs. 12, 13 and 14). In addition, information retrieved from the FDR shows that Tq 1 increased from 31.4% to 51.5%
- At T + 1.7 secs, the CVR recorded an intense crunching of around 0.6 seconds' duration. During this period, the frequency from the Nf 2 disappeared, and Tq 1, T4 1 and T4 2 dropped rapidly towards zero. Ng 1 increased during this period from 96.7% to 98%, and Ng 2 continued to increase to around 100%
- Ng 2 continued to increase after T + 2.3 secs. and reached 105.7% at T + 3 secs. Ng 2 stabilised at 104% for 5 secs, only then to drop towards zero when the recording was terminated
- Ng 1 continued to increase to 103% at T + 2.5 secs and then continued at 100% - 103% until the recording was terminated
- Nr began to drop from 101.5% at T to 97% at T + 2.3 secs. A Low Nr warning with a duration of 1.3 secs was first recorded at T + 2.3 secs. Then, RPM dropped further to 26% at T + 9 secs. After this, Nr increased and reached 95% when the recording was terminated. At the same time, coincident variations of the oil pressure in the main gearbox were recorded. This pressure will vary with the RPM of the gearbox.
- Recorded data show that the helicopter went completely out of control after T + 2.3 secs. For example, recorded acceleration data begins to vary on all three planes.
- The co-pilot tried to transmit Mayday, Mayday, Mayday from T + 13.5 secs. until the recording was terminated two seconds later. This call was recorded by the CVR only as an internal communication because the radio had not transmitted the call.
- The CVFDR did not record information after T + 15.4 secs.

The following is also included in the information from CVFDR:

- The helicopter flew at an altitude of approx. 1 830 ft (QNH) right up to T. The FDR did not record any reliable values for altitude after 1 795 ft was recorded at T + 11.6 sec
- The helicopter maintained a stable heading on 288° M up until T - 4:40 min. The helicopter then turned and flew on a heading of 260° M for 46 secs. before establishing a heading of 267° M at T - 3:19 min., which it maintained up until T
- The helicopter flew at a speed of around 120 KIAS right up until T.

1.12 The accident location and the aircraft wreckage

1.12.1 The accident location

In the Norwegian Sea (the Norne field), approx. 100 NM west north west of Brønnøysund (66° 04' 25" N 008° 34' 21" E). The helicopter wreckage was found on the flat muddy seabed at a depth of approx. 380 m.

1.12.2 The aircraft wreckage

1.12.2.1 *Pieces floating on the sea*

On the day of the accident, pieces of wreckage from the helicopter were found floating on the sea. Included among these pieces were a complete, almost undamaged, main rotor blade with blade sleeve, almost all parts from the air intake cowling, the R/H and L/H engine cowling and the engine sliding cowling. Also found were parts of two other main rotor blades, a raft plus seat cushions and other parts of the interior. Examinations of the engine cowlings showed that the L/H engine cowling was split into two in an area beside the power turbine, that it had a coating of soot and that parts of the housing were affected by heat damage. The R/H engine cowling bore marks of having been cut in two on a level with the power turbine. The engine sliding cowling had no soot coating apart from what might naturally be expected, but it had considerable damage on the top.

1.12.2.2 *Location and salvage*

The helicopter was located on the seabed by means of a hydrophone on loan from and operated by the United Kingdom Air Accidents Investigation Branch (AAIB). This work was carried out free of charge. The hydrophone was towed 80 m behind the diving operations support vessel, Rockwater 1, at a speed of approx. 4 kt. The distance between each search was 1 NM. The initial search area was limited to approximately 12 x 10 NM. The hydrophone picked up signals from the acoustic transmitter on the CVFDR after searching for around 24 hours. Most of the parts from the helicopter wreckage were found inside a limited area of 100 x 100 m. Only smaller parts were found outside this area.

During the salvage work, Remotely Operated Vehicles (ROVs) from the diving operations support vessels, Rockwater 1 and Seaway Pelicane, were used. The

helicopter's tail was raised, as the first section, on 12 September. The parts were either stropped directly or were placed in huge baskets and then hoisted up. During the work of raising the cabin, this split in two so that only the rear section (behind the rear main door, main frame 5295, see fig. 2) came up. The raising of the remaining sections of the cabin presented major problems and the work was only successful once the sections of wreckage were moved into one large basket. The last sections were taken up on 19 September, after having been lying in the sea for 11 days. Not all of the located sections of the wreckage were raised because the remaining identified sections were assessed as being without significance to the investigation work.

As they came up onto the deck of the boat, the sections were rinsed one after the other with fresh water. After the salvage operation was concluded, the sections of wreckage were shipped to the Board's premises at Kjeller for more detailed examination.

1.12.2.3 *The helicopter cabin and cockpit*

The majority of the helicopter's cabin, including the cockpit, was found together in one place, held together by rods, wiring and tubes, but otherwise the structure was completely destroyed. The gas generator section from both of the engines was stuck to the cabin roof. A more detailed examination of the cabin showed that parts of the cabin roof on the R/H side beside main frame 3855 had been cut on a level with the power turbine. Several of the helicopter's vital flight control rods, which run in this area, were also cut. This is marked on fig. 15a and discussed in more detail in subparagraph 1.16.4.3. In addition, there were clear signs of the effects of heat on the cabin roof in the area behind the L/H engine both on the topside and underside. The forward suspension bar of the main gearbox is seen in the middle of fig. 15a, as it was found, affected by heat and split in two approximately in the middle. The two rear suspension bars had been ripped out from the cabin roof in such a way that the attachment bracket had been ripped loose on the L/H side and the bracket had snapped on the R/H side. The flexible titanium plate supporting the main gearbox was ripped loose, causing a piece of the cabin roof to come loose at the forward attachment point, and the fixing bolts to shear off at the rear attachment point.

The cabin had compression damage and had sustained the most serious deformation at the front and on the L/H side. In addition, the fireproof bulkhead between the engines had impressions indicating that the engines had moved forward very forcefully, to the left and down a little.

Only sections of a few passenger seats were raised. In the section in which the floor remained intact (rear mainframe 5295), all of the seats had been ripped out of the seat fixing rails.

1.12.2.4 *The helicopter's tail and tail rotor*

The helicopter's tail, including the tail rotor, had separated at main frame 9000, but were found right next to the cabin. The tail boom was bent to the right in the middle, and the tail fin with the 90° gearbox and tail rotor had, in part, been torn loose from the tail boom. All of the tail rotor blades had been broken in half, and all of the flap stops had

been destroyed because of overload in movement towards the tail fin. Two of the blades had sliced into the tail fin without there being any sign that the rotor had been rotating at the time of the impact. The tail rotor shaft had insignificant damage caused by rotation.

1.12.2.5 *L/H engine*

All sections from the L/H engine were raised with the exception of parts of bearing no. 5 and the power turbine with the forward shaft section. The engine was found split in two parts between the gas generator section and the power turbine section. The gas generator section from the engine was found firmly mounted on the cabin roof. The housing for the power turbine with bearing no. 6 and shaft, plus phonic wheels, Bendix shaft, speed probes, liaison tube and exhaust pipe was found separately (see fig 15b).

The engine's oil system was initially examined at the AAIB/N premises. This showed that there were no chips on the turbine's chip detector. The L/H engine, with the exception of the Bendix shaft and the liaison tube, was then sent to Turbomeca in Bordes in France for more detailed examination, in the presence of an AAIB/N representative. The investigations concluded that the engine was airworthy before it was subject to considerable damage in the area facing the R/H engine's power turbine (see subparagraph 1.16.6.2 for a detailed description of the results of the investigation).

1.12.2.6 *R/H engine*

All sections of the R/H engine were raised with the exception of parts of bearing no. 5 and the power turbine with the forward shaft section and associated containment rings. Only parts of three turbine blades from the power turbine were found. The engine was found in two parts, with a split in the housing surrounding the power turbine section. The gas generator section from the engine was found firmly mounted on the cabin roof (see fig. 16a). The rear part of the power turbine housing with bearing no. 6 and shaft, plus phonic wheels, the forward part of the Bendix shaft and the liaison tube, speed probes and the exhaust pipe were found separately (see fig. 16b).

The engine's oil system was initially examined at the AAIB/N premises. This showed that the scavenge pump for the power turbine had a lot of contamination in the inlet screen, but there were no chips on the turbine's chip detector. The R/H engine, with the exception of the Bendix shaft and the liaison tube, was then sent to Turbomeca in Bordes in France for more detailed examination, in the presence of an AAIB/N representative. The result of the examinations can be summarised by stating that the engine was airworthy when the helicopter took off from Brønnøysund on the day of the accident (see subparagraph 1.16.6.3 for a detailed description of the investigation results).

1.12.2.7 *The helicopter's main gearbox (MGB)*

The main gearbox, with the rotorhead and parts of two rotor blades, was found separated from the helicopter on the seabed. The upper part of the forward suspension bar and the two rear suspension bars were firmly attached to the gearbox (see fig. 17a).

The bars were visually inspected to discover whether there had been any play or abnormal wear in the attachments. Nothing abnormal was discovered. The mounting bolts between the suspension bars and the gearbox were bent due to overload, particularly the bolt for the front bar. The front bar was investigated by DNV. This showed that the part that was affixed to the gearbox had not been visibly affected by heat. In addition, it was established that the suspension bar had failed due to overload in tension. (See subparagraph 1.16.4.4). A visual examination of the flexible titanium plate below the MGB showed that the plate's attachment points had not had any defects prior to it failing due to overload.

Two main rotor blades had been ripped loose from the rotorhead because the blades' sleeves had come loose from the blades' spindles. This had taken place without the nut having rotated and without the respective thread sections having been subject to any considerable damage. The rotorhead had major damage resulting from overload, with all the frequency adapters ripped loose, among other things (see fig. 17b).

The tie-bolts on the L/H side were split in two and the L/H liaison tube was removed in its entirety. The L/H shaft input and the splined sleeve were found without any visible damage. The O-ring and lock washer were in place. On the R/H side, parts of the R/H liaison tube and the Bendix shaft remained on the gearbox (see fig. 18a).

Because salt water immediately attacks the magnesium alloy in the gearbox housing, disassembly of the gearbox was prioritised after its arrival at AAIB/N premises. During disassembly of the rear end of the R/H liaison tube and the Bendix shaft, it became clear that the splined sleeve had been split into several parts, and that the O-ring on the splined sleeve was missing (see fig. 18b). For a detailed description of these parts, see subparagraph 1.16. It was also concluded that even though the lock wire was secure and prevented rotation, the tie-bolt, which attaches the R/H liaison tube, was loose without a tightening moment.

Disassembled parts from the MGB were the subject of visual inspection. No damage was found on any rotating components or bearings. The magnetic plug in the oil system contained no abnormal metallic chips. The results of detailed examinations of major components of the MGB are described in 1.16.

1.12.2.8 *Details from the cockpit*

The cockpit was badly devastated. Switch positions, instruments and levers provided little information that could be assigned any meaning. The artificial horizon for the pilot-in-command, however, showed a 30° bank to the left and 35° nose-down. This could represent the impact position against the surface of the sea. An examination of the light bulbs in the OVSP 2 and GOV 2 lights showed that three out of four bulbs in OVSP 2 lit up when they were tested. The filament in the fourth bulb was broken in such a way as to indicate that the bulb had not been lit when it was broken. All of the bulbs in GOV 2 lit up when tested.

1.12.2.9 *Reconstruction of parts of the wreckage*

Parts of the cabin roof and the engine housings were reconstructed in order to obtain the best possible overview of the damage in the area surrounding the engines. The pictures in fig. 19 show the R/H (top) and L/H side, respectively, after reconstruction. The plane of rotation of the two stages in the power turbine is highlighted on the picture, which also shows some of the damage caused by fragments from the turbines. The picture taken from the left shows the difference in the amount of soot on the engine cowling and the engine sliding cowling.

1.13 **Medical and pathological information**

1.13.1 Autopsies were carried out on the crew and on all passengers. The autopsies show that everyone died as a consequence of injuries caused by the impact with the surface of the sea. No medical conditions that could have influenced the accident were found, nor were any other findings revealed which could have been significant to the accident. No ingestion of alcohol or medication by the crew were found at the autopsies.

1.14 **Fire**

The L/H engine cowling and components behind the L/H engine had considerable fire and heat damage. The temperature in this area had been so high that there had been discoloration of the underside of the cabin roof.

1.15 **Survival aspects**

1.15.1 General information

1.15.1.1 The helicopter was equipped with the emergency equipment for offshore flying as required by the civil aviation authorities.

1.15.1.2 The pilot-in-command was dressed in a dark blue, non-insulated flying suit, jeans, T-shirt, short underwear and low shoes. The co-pilot was dressed in a dark blue non-insulated, flying suit, T-shirt, short underwear and low shoes. The passengers were wearing orange, insulated survival suits. Please refer to AAIB/N report no. 2/98 regarding the aircraft accident involving LN-OBP in the North Sea on 18 January 1996 for a more detailed description of survival options during emergency landings by helicopter at sea.

1.15.1.3 The helicopter had an Emergency Locator Transmitter of the Automatic Deployable Emergency Locator Transmitter (ADELT) type, model CPT 600. This was mounted in the L/H sponson on the helicopter and could be actuated either manually or automatically. On actuation, it is released by a spring so that it is discharged upward and backward. During the impact with the surface of the sea, the Emergency Locator Transmitter was so damaged that it neither was ejected nor did it begin to transmit.

- 1.15.1.4 On the basis of experience from the British sector of the North Sea, HS advised against type approval and use of this Emergency Locator Transmitter when the type came on to the Norwegian market. However, the type was approved and installed into helicopters belonging to AS Mørefly. On its takeover of this fleet of helicopters, HS also became a user of the type.
- 1.15.2 The search operation for HKS 451
- 1.15.2.1 Last radio contact with HKS 451 was at 0655 hours and the helicopter should have landed on the Norne at 0706 hours. When the landing did not take place as expected, the Joint Rescue Coordination Center North-Norway [Hovedredningsentralen for Nord Norge (HRS-N)] was notified by Bodø ATCC at 0718 hours. HRS-N took control of the search operation and immediately notified 330 Squadron at Bodø and at Ørlandet, and 331/334 Squadron at Bodø. At 0730 hours, 333 Squadron at Andøya was notified. This led first to two Sea King rescue helicopters and two F-16 fighter aircraft, and later an Orion surveillance aircraft, setting course for the search area.
- 1.15.2.2 The F-16s were first to arrive in the area and were assigned a search area delimited by sectors 080° M to 120° M out to 30 NM from the Norne (covering the route TANGO 90 - Norne, see fig. 20). At 0854 hours, the operation was upgraded to a Mayday Relay and a search area with a radius of 23 NM from 6600N 00803E was established. The search areas were selected on the basis of information from the submitted flight plan and the last radio contact with the helicopter. Early in the search phase, the rescue services management obtained information from the air traffic control service in Bodø that the helicopter had been seen on radar and that it could appear as if it had followed a direct route from reporting point HELIK to the Norne. According to Bodø Air Traffic Control Center (ATCC) controllers, it did sometimes happen that helicopters deviated from the route in the submitted flight plan without this being notified to the air traffic control centre. Route TANGO was not visible on the radar screen and minor deviations in relation to the submitted flight plan were therefore difficult to detect. The radar had no equipment for recording radar data and the information could consequently not be verified. However, the information was assessed as being so certain that it had to be taken seriously. First it was assumed that the helicopter had landed on the sea and had stayed afloat. The COSPAS/SARSAT satellite system was therefore monitored for any signals from the helicopter's Emergency Locator Transmitter.
- 1.15.2.3 The initial search area by the Orion was planned to be between the assumed position of last radio contact and the Norne with the direct route as an axis (see fig. 20, A1). The Orion was on station at 0940 hours and commenced the search with additional responsibility as On Scene Commander (OSC). The rescue helicopters from Bodø and Ørlandet were then already in position and had started searching. At 0930 hours, the F-16s landed in Bodø without having observed anything in their assigned area. Because monitoring by the COSPAS/SARSAT had not produced any results so far, the rescue management had to take into account the fact that the helicopter could have sunk and that it would be necessary to assess the search area, on the assumption that small objects would have to be looked for, such as rubber dinghies, people in survival suits and possibly wreckage. At 1025 hours, a Jet Falcon from 717 Squadron was

placed at the disposal of the OSC and the search area was extended to include the area between the first established area (A1) and route TANGO. At 1102 hours, the Orion's assigned area of responsibility was extended to take in route TANGO between TANGO 60 and TANGO 90. It was also given information that the expected route for the helicopter might be direct from TANGO 90 to the Norne. These changes came as a result of factors such as the input from an HS representative assigned to the HRS-N. At 1132 hours, the Jet Falcon left its area to refuel at Bodø. The crew's efforts had so far resulted in no observations. At 1220 hours, the OSC's area of responsibility was modified to 6603N 00813E - 6610N 00916E - 6555N 00916E - 6555N 00813E (see fig. 20, A2). This meant a renewed search in areas already searched by both the F-16s and the Jet Falcon. At 1153 hours, a C-130 from 335 Squadron arrived at the search area.

- 1.15.2.4 At 1322 hours, the Sea King helicopter from Bodø observed wreckage at position 66°04.5' N 008°39.7' E. Two casualties in survival suits were then picked up by the rescue helicopter. From then on, the operation changed in nature to concentrate forces in a search for possible survivors who might be onboard a rubber dinghy or who might be floating on the sea. Data such as current, wind, wave height and visibility conditions were crucial for establishing steadily modified search areas. These were moved in relation to the expected drift of relevant search objects with additional margins for error (from tables). Using this as a basis, an assumed accident site was estimated. At 1415 hours, the search area was changed again (see fig. 20, A3).
- 1.15.2.5 At 1300 hours, a total of two helicopters and 5 aircraft were involved in the search operation. In addition, 18 vessels had begun to search in the area. The number of units participating in the search varied right up until the time at which the helicopter wreckage was located.

1.15.3 Reconstruction of the helicopter's route

Using data recorded on the helicopter's flight recorder as a basis, the AAIB/N has reconstructed the helicopter's route using the accident site as the starting point. The reconstruction cannot be completely accurate since the helicopter's movements are unknown after it went out of control. The wind and wind direction at an altitude of 2000 ft has been estimated, based, among other things, on the wind observed at the Transocean Prospect (close to the vessel Norne) in comparison with the forecast wind. It is assumed that the deviation on the helicopter's compass system was equal to 0 on the relevant courses. The reconstruction gives a result that indicates that the helicopter flew a little north of HELIK, and after two minor corrections to the course, maintained a steady course that crossed route TANGO at a small angle, to a point a good nautical mile south west of TANGO 90. From this point, the helicopter went straight towards the vessel Norne. This shows that, in practice, the helicopter adhered to the flight plan submitted.

1.15.4 Basic information for the search

One of the reasons for submitting a flight plan to the air traffic control service is to ensure that, in the event of any search due to an emergency situation, it provides the basis for establishing a search area that covers the probable area in which the aircraft has been operating. According to the company, it endeavours to ensure that all flights adhere to a flight plan unless otherwise agreed with the air traffic control service.

Apart from the flight plan, factors that have to be taken into consideration when establishing a search area include the last radar/radio contact and weather conditions: particularly visibility and, over sea areas, especially currents and wind plus wave height. Also important in assessing the size of the search area and the distances between the search lines, is whether it might be expected, as in this case, that the aircraft would remain afloat or whether the search should be based on finding people in survival suits, rubber dinghies and possibly flotsam. Under ideal conditions, experience has shown that the maximum degree of detection that can be expected during the first thorough search of an area is 78%.

1.16 Tests and research

1.16.1 Examinations at DNV of the main gearbox (MGB) R/H shaft input

1.16.1.1 *Introduction*

During disassembly of the helicopter's MGB, the splined sleeve, which is part of the main gearbox R/H shaft input, was found to be split into several parts. The parts that had come loose were located inside the splined flange on the R/H Bendix shaft and partially fell out when this was being removed. The circlip and lock washer normally attached to the splined sleeve were found together with fragments of the Bendix shaft in the area between the phonic wheels and the liaison tube on the R/H engine. To prepare more detailed examinations at DNV, the entire R/H shaft input was removed (splined sleeve, input pinion together with bearing and lock nut). Expanding products of corrosion from the gearbox housing had pushed the shaft input forward such that three attachment lugs had been broken off (see fig. 21). This made the disassembly work difficult. Before the shaft input was disassembled, the tightening torque of the lock nut was found to be within the tolerances. The same was true of the nut that attached the rear bearing to the input pinion. The amount of shaft eccentricity on the input pinion was measured at 0.02 mm after all parts had been disassembled. The examination work carried out on the R/H splined sleeve is discussed in DNV report no. 98-1118, amendment no. 02.

1.16.1.2 *Visual examination of the splined sleeve, lock washer and circlip*

The splined sleeve was found split into 13 parts. The surface along the external splines was partly covered in a thin film of a rusty brown coating. When the parts were put together, it appeared that only two minor fragments were missing. Fig. 22 shows 11 of the parts, and figs. 23 and 24 show a reassembly of the splined sleeve in which all of the parts are placed in position. Active flanks on the teeth showed that the splined sleeve

had been subject to oblique loads and that the contact against the surfaces had gradually moved axially (see fig. 25). The drawing in fig. 26 shows the wear on the splines (depth indicated by black columns, with X showing areas that were not measured due to the lack of measurement references). A visual examination shows that there was also wear/fretting on the teeth that had come loose and could not be measured; for example, teeth nos. 6, 7, 14 and 15. Any fretting on the cylindrical areas of the splined sleeve is marked on fig. 26 by hatching. Cracks in the same area are marked with a stippled line, and the position of the crack in the splined flange is marked with a solid red line.

An area with internal micro splines in the front edge of the splined sleeve had damage corresponding to the type of damage that might arise in the event of abnormal contact between the splined sleeve, lock washer and circlip (see fig. 27). The lock washer had damage in two areas with micro splines, one of which is shown in the picture in fig. 28. The picture shows that the part has been exposed to hammering and has minor damage. Arrows on the picture indicate two areas that have been deformed due to contact with the lock nut (see fig. 29). The circlip was whole, but rather deformed, at one end in particular, so that its cross-section had become triangular.

1.16.1.3 *The pattern of cracking on the splined sleeve*

To improve the overview of the crack pattern on the splined sleeve, the external teeth were numbered from 1 - 18. One tooth without visible damage was selected as no. 1. The fracture surfaces were examined with an Optical Stereo Microscope (OSM) to find the initiation point and direction of propagation. Particular emphasis was placed on areas in which cracks branched or crossed other cracks. The examination led to the propagation of the pattern of cracking being well on the way to clarification. To improve this overview, the propagation has been divided into three phases as described below:

First phase

Cracks of single or multiple origin were initiated from the lower area of the active flank surfaces on teeth nos. 6, 7, 14 and 15. These cracks went down in the material before curving and coming up onto the "back" of the spline such that several sections of the teeth came loose. These cracks did not go all the way through to the inside of the splined sleeve. The arrows on figs. 30 and 31 indicate the initiation points.

Second phase

Cracks arose around teeth 4 and 5. The cracks went through the wall to the inside of the splined sleeve where they partly followed the radius of the mating surface for the locking nut. During this phase, a crack reached the front edge of the splined sleeve. Red dotted lines on fig. 32 illustrate internal crack position, and arrows indicate initiation points and the direction in the crack propagation.

Last phase

A series of cracks arose with both internal and external initiation points. The cracks that arose during this phase are included on fig. 33.

1.16.1.4 *Fracture examination of the splined sleeve*

Selected crack surfaces were examined in detail using the Scanning Electron Microscope (SEM). During this work, only fatigue cracks were discovered. Fig. 34 shows pictures of two representative cracks. The following quotation is taken from the DNV report:

"The micro-fractographic examination of selected fracture surfaces by use of a SEM has brought to light that both the transverse, tangential and longitudinal (axial) fractures are a consequence of single- or multiple initiated fatigue cracking. The SEM micropatterns of the locations involved show an almost similar appearance regarding fracture surface topography and intensity of microcracking."

1.16.1.5 *Examination of the surface coating on the splined sleeve*

The examination of the hardmetal coating on the splined section of the splined sleeve has shown that the thickness of the coating varied between 14 μm and 32 μm on surfaces that were not affected by wear (see subparagraph 1.6.7.3 for information on the coating). On the basis of visual observations of the microstructure, DNV is of the opinion that the porosity of the coating is considerably above the tolerances indicated by the coating supplier (0.7 - 1.0%). No exact calculations of the porosity of the coating were carried out.

The examination of the hardmetal coating using the SEM disclosed several irregularities. Fig. 35 shows two pictures of longitudinal scratches and detachment of the coating on the inactive surface on tooth no. 6. Fig. 36a shows that the longitudinal scratches gradually bend away towards the top of the tooth when they reach high on the surface of the tooth. Another example of the fact that not all scratches are longitudinal is shown in figs. 36b and 37a, where the horizontal scratches run over the vertical ones. Fig. 37b shows an area of the inactive surface on tooth no. 6 that has been subject to mechanical loads. Fig. 38a shows an area on the inactive surface on tooth no. 6 in with a cavity under the hardmetal coating. Fig. 38b shows that longitudinal scratches were also found down between the teeth. To examine whether scratches in the hardmetal coating were limited to tooth no. 6, the inactive surface on tooth no. 2 was examined. This tooth was scratched to a minor extent, and the scratches were linked, to a far less extent, to the detachment of the hardmetal coating as shown in fig. 35.

Metallographic sections through parts of the splined sleeve show that there is lamination and considerable porosity in the hardmetal coating (see fig. 39). In addition, this shows that the size of the tungsten carbide particles varies considerably, and that there are grains with a size which is equivalent to or which exceeds the thickness of the

coating (see fig. 40). Fig. 41 shows a section through one of the initiation points for one of the cracks that caused tooth no. 6 to come loose.

1.16.1.6 *Metallographic examinations of the splined sleeve*

ECF gave DNV access to drawings and material specifications for the splined sleeve. Metallographic examinations have shown that the splined sleeve in question (not including the applied hardmetal) is within the specifications given by the factory. The following quotation is taken from the report:

"The metallographic examination carried out has confirmed that the splined sleeve material is a quenched and tempered steel with a mainly martensitic microstructure. The hardness of the material is found close to the upper limit of the specified hardness range. No material defects or significant material irregularities have been noted."

"By the semi-quantitative analyses carried out by DNV, no significant deviation from the specified chemical composition of the material in question has been brought to light."

1.16.1.7 *Conclusions drawn from the examination of the splined sleeve*

The following quotation is taken from Concluding remarks in DNV report no. 98-1118, amendment no. 02:

"Based on the DNV examination carried out, it is indicated that the R/H side splined sleeve suffered the first sequence of failure (fatigue cracking) before any fatigue crack was present in the end flange of the Bendix shaft. This because the crack recording of the sleeve revealed a first sequence of failure from two almost diametrically opposite locations (teeth No. 6 - 7, teeth No. 14 - 15, respectively,"

and

"The hardmetal coating of the exterior sleeve surface has been found locally beyond specification regarding surface depth. The coating did also include locations showing laminating defects, a significant inhomogeneity of the particle size, and an elevated level of porosities."

1.16.2 Examination at DNV of the R/H Bendix shaft with the splined flange

1.16.2.1 *Visual examination of the Bendix shaft and splined flange*

The Bendix shaft was found split into three main parts (see fig. 42). The front end and parts of the forward bellows section were attached to the engine with bolts, in the prescribed manner. The central section had separated at a fracture in the forward bellows section and at the transition between the thin and thick shaft walls close to the rear bellows section. The shaft section had gained a spiral shape along a crack that ran from the rear fracture forward to the front. Examinations of the crack in the OSM

showed that this was a 45° shear fracture characteristic of a fracture caused by regular material overload. The rear part of the shaft, including the splined flange, was in place on the gearbox R/H shaft input. Furthermore a series of fragments of the shaft wall were found, originating from the shaft fractures, particularly from the rear. In parts, the rear part of the "spiral" had major mechanical damage. A series of scratches and abrasions were found on the inside of the shaft wall, particularly at the rear end. Examination of this shows that they were caused after the cracking and deformation of the shaft. The rear part of the Bendix shaft and the liaison tube are shown in fig. 18 a. On the picture, scratches are visible on the bellows. These were caused by a rotating movement between the two parts of the Bendix shaft. Examination in the OSM of the shaft fracture on fig. 18a, showed that it was also a 45° shear fracture. Fig. 43a confirms that this was an overload fracture.

By removing six attachment bolts, the splined flange became separated from the Bendix shaft (see figs. 44a and 45). It was established that the part had been split by a crack that could be followed from the front edge, backward over the section with internal splines, radially out along the mounting flange and right out to a collar on this. Fig. 46 shows a sketch of the crack. Fig. 47 shows internal splines on the splined flange in an area in which part of one tooth is missing. The picture also shows deposits of a black/brownish coating that was so firmly attached, in places, between the teeth that tools had to be used to remove it (this is discussed later under subparagraph 1.16.2.4). Examination in the OSM of active flanks on the teeth showed that these had a rough surface containing fretting corrosion and zones with traces of considerable mechanical wear. This covered the entire flank, but was at its maximum right at the back. The inactive flanks had insignificant fretting corrosion. However, individual traces of mechanical wear were observed along the flanks with the most significant wear on the front edge.

1.16.2.2 *Fracture examination of the splined flange*

The splined flange was cut along tooth no. 16 and the "remainder" of the crack was broken up so that it could be split in two. This provided the opportunity to examine the fracture surfaces. After chemical cleaning and examination in the OSM, it was possible to ascertain that the crack had started internally, close to the root and far forward on the tooth close to tooth no. 7 on the splined sleeve (see figs. 46 and 48). In addition, it was established that there was a fatigue crack (see fig. 49) and that it had developed forward and backward from the initiation point.

1.16.2.3 *Metallographic examination of the splined flange*

A section through the teeth on the splined flange showed that active surfaces on the teeth had considerable mechanical wear in a range of depths from 0.16 to 0.24 mm. Furthermore, indications of fretting corrosion were discovered and traces of local deformation (smearing). The rear part of the splined flange had internal wear of 0.1 mm as shown in fig. 43b. The distance "a" represents the width (3.1 mm) and the position for the groove for the O-ring on the splined sleeve. The equivalent wear to the left of "a" was 0.05 mm, but the transition was gradual between areas with and without wear.

With regard to the material's properties, the following quotation is taken from the report's conclusions:

"The quality of the end flange material, related to mechanical properties / heat treatment / hardness and also chemical composition, is found to correspond to relevant material specifications."

The results of the examination are described in DNV report no. 98-1276, amendment no. 01.

1.16.2.4 *Analysis of deposit found on the splined flange*

During the disassembly of the splined sleeve and the splined flange, it was established that the sections were partially coated in a brownish deposit (see fig. 44a). Between the teeth, internally on the splined flange, this deposit was hard and firmly attached (see fig 47). As can be seen from fig. 44b, the deposit contains solid particles. An analysis showed that this was principally iron (Fe) and tungsten (W), but magnesium (Mg), calcium (Ca), molybdenum (Mo) and sulphur (S) were also found (see figs. 50 and 51).

1.16.3 Evaluation of the speed of crack propagation on the splined sleeve and the splined flange carried out by DNV

1.16.3.1 *Assessment of methods*

DNV chose to try three different methods of evaluation of fatigue crack propagation to chart the speed of crack propagation in the fatigue cracks. A description of these methods is given below:

Method A

To count striations per unit of length along the crack by means of the SEM. By relating one striation to one revolution of the Bendix shaft, the crack's total "life" can be arrived at when the shaft's RPM and the length of the crack are known. Counts of striations undertaken by DNV showed that the cracks on both the splined sleeve and the splined flange propagated at an almost constant speed (6 600 - 10 800 striations per unit of length (mm)). However, this method was rejected by DNV since it was probable that the shaft had rotated through several revolutions between each striation, and that consequently these two conditions could not be related to one another.

Method B

To photograph the cracks by means of the SEM to produce the pattern of lines (beach marks) in the crack. By comparing this line pattern (assuming that one departure represents one line, and the distance between the lines represents the duration of the flight, see subparagraph 1.18.2.1) with a visual presentation of the flights (see fig. 52) based on the helicopter logbook, it might be possible to determine a timeframe for the

development of the fracture. This method can be verified if the crack toe coincides with the relevant pattern at the time of the accident.

For this purpose, DNV made a series of pictures at magnifications of X 80 and X 120, and pictures at magnifications of X 12 - X 20, lit at an oblique angle. Independently of one another, several people tried to make visualisations of flight times in the helicopter logbook agree with these crack patterns, but without success. Since only sporadic links were found, this method was rejected.

Method C

To count marked lines (beach marks) on SEM screens at magnifications of X 9 - X 80 (see fig. 49). Assuming that these represent one cycle = a flight, the number of flights can be determined. By going into the helicopter's log, the average duration of a flight can be determined and the total life of a crack can therefore be estimated. This method is based on the assumption that the crack propagates at almost constant speed. DNV has based its calculations on this method. This is described below under subparagraph 1.16.3.2.

1.16.3.2 *Results from an evaluation based on Method C*

DNV examined two separate cracks on the splined sleeve and found 33 lines (beach marks) along a 17.9 mm long crack, and 40 lines along a 21 mm long crack, respectively. This gives an average distance between the lines of 0.54 mm and 0.53 mm, respectively. The two cracks concerned are part of a complex pattern of cracks in which it is not possible to determine the "correct" distance between the crack's initiation and end points. However, DNV believes that the examination confirms to ECF the finding that the shortest distance that the crack can have gone constitutes 79 lines (see subparagraph 1.16.5.4).

As opposed to the cracks in the splined sleeve, the crack in the splined flange has a known distance between the initiation point and the crack toe. Counts along this crack (see fig. 49) showed that there were 26 lines to a point 20.2 mm from the crack toe, and that there were 38 lines to a point 28.8 mm from the same crack toe. This gave a distance between the lines of 0.76 mm and 0.78 mm, respectively. A study of the helicopter logbook made it clear that the last 26 flights had lasted an average of 34.6 mins, and that the last 38 flights had lasted an average of 35.5 mins. The total length of the crack in the splined flange was measured at 80.5 mm and, based on an average distance between the lines of 0.77 mm, this gives 105 lines. On the assumption that one line represents one flight, the helicopter log shows that the last 105 flights represent a flying time of 61 hours and 35 mins. (see Appendix E).

The following quotation is taken from DNV report no. 99-1265:

"The DNV fatigue estimate is based on the assumption that the crack propagation speed is almost constant, which is indicated by the SEM striation counts, and also that the individual and rather distinct crack surface zones each representing an operational cycle.

Out of the cracks involved in the testing, the Bendix shaft end flange is found of most importance, as this one shows a well defined crack length from the fatigue start location to the distinct fatigue crack toe.

From the use of the method C and the surface appearance of the end flange crack, it is estimated by DNV that this crack has been present during the ~105 last operational cycles, corresponding to ~61.5 hours."

1.16.4 Examination at DNV of other relevant components

1.16.4.1 *Speed probes and phonic wheels*

Phonic wheels from the R/H engine and four speed probes (two from the R/H and two from the L/H engine) were sent to DNV for examination. The results of the measurement of wear on the speed sensors coincide with the measurements carried out by Turbomeca (further information in subparagraph 1.16.6). Speed probes from the R/H engine were found to have a series of metallic particles located on the speed sensors. Examinations of these using the Energy Dispersive Spectrometer (EDS) linked to the SEM, showed that the particles could be expected to originate from the damage that had occurred within the liaison tube during the break-up of the Bendix shaft.

An examination of the teeth on the phonic wheels showed that the rear wheel (55 teeth) had most traces of contact with the speed sensors. All of the teeth, apart from 10 teeth in one sector, had scratches and scores. The central wheel (36 teeth) had one sector of approx. 90° with marked wear on the teeth and one sector of approx. 45° with little damage. The front wheel had least wear. None of the teeth examined were damaged or worn in such a way that any height variations could be measured on the teeth.

The examination work carried out on the speed probes and phonic wheels is discussed in DNV report no. 2000-1210, amendment no. 01.

1.16.4.2 *Liaison tube*

The R/H liaison tube and the rear half of the L/H liaison tube were sent to DNV for examination (see fig. 53). The rear half of the R/H liaison tube was split in two in an area that also had two marked folds due to axial bending. The fracture was found to be an overload fracture. The interior of the R/H liaison tube had several transverse scratches and areas of damage of which several were so powerful that they had created external bulges and, in some cases, cracks in the tube wall. Examples of such bulges have been marked on fig. 53.

The joint on the liaison tube (the gimbal joint assembly) was disassembled and examined. This showed that all active contact surfaces on the four bolts (fingers) and the associated linings had considerable traces of wear, fretting and corrosion. The depth of wear on the bolt with most wear was measured at a maximum of 0.24 mm. Two other bolts showed signs of blue coloration, something that indicated locally high heat due to friction contact. The tempered surface of the bolts was found to have a hardness of 760 HV5. The measured value for the bolt's core material was 360 - 380 HV5. The

corresponding figure for the linings was 760 - 849 HV1 for the surface and 368 - 389 HV1 for the core material. Small cracks were found in the fillet on the four linings from the R/H liaison tube and in the one that was examined from the L/H liaison tube. DNV has not been able to ascertain the cause of these cracks.

Figure 53 shows that the rear half of the L/H liaison tube also has bulges that show that the component has been exposed to axial bending forces.

The examination work carried out on the R/H and L/H liaison tubes is discussed in DNV report no. 2000-1129, amendment no. 01.

1.16.4.3 *Control rods*

The control rods from the cockpit to the main rotor and the tail rotor runs in the cabin roof at a level of approx. 32 cm below the engines. Three of these rods were found cut in the area below the power turbine on the R/H engine. To establish the cause of these fractures, parts of the rods to the Forward Servo Control, R/H Servo Control and Tail Rotor Servo Control were sent to DNV for examination. The examination showed the following:

- The Forward Servo Control Rod was cut in two places around 10 cm apart. The intermediate piece was missing. The forward section of the rod was 550 mm long including the end piece, and this is consistent with the rod having been cut by fragments from the first stage of the power turbine.
- The part of the R/H Servo Control Rod which was available for examination was 685 mm long, including the end piece. The length is consistent with the rod having been cut by fragments from the power turbine's second stage. Residues of oil spray were found on this rod, close to the cut.
- The Tail Rotor Servo Control Rod was clearly pierced through at the fracture location. The outlet hole was approx. 12 x 18 mm.

The examination results are reproduced in DNV report no. 2000-1255, amendment no. 01. The report draws the following conclusion:

"The examined fractures of the servo control rods are all found to be a consequence of a ductile material overload, caused by cutting, bending (buckling) and tension."

1.16.4.4 *Suspension bar*

The helicopter's MGB was found separated from the helicopter. Figs. 15 and 17 show that the front suspension bar was split in two. The two halves were examined by DNV to establish the cause of the fracture. The examination showed that the bar had failed due to overload in traction and the effect (though mild) of bending. The traction forces had also led to plastic deformation of the tie bolts. In addition, it was found that the lower part of the bar had been affected by great heat. The heat had affected the painted

surface and melted a small aluminium plate that is assumed to have been a data plate. The upper part of the rod was unaffected by heat. The dividing line between those parts of the rod affected by heat and those not affected by heat goes along the fracture surface. The examination results are reproduced in DNV report no. 2000-1255, amendment no. 01.

1.16.4.5 *Examination of the tie-bolt*

A tie-bolt that attaches the liaison tube to the MGB was found to be broken during a PFC on 3 August 1997 (cf. subsection 1.6.6.5). The bolt was stored at HS, and submitted to the AAIB/N after the accident. The AAIB/N sent it to DNV for metallurgical examination. The result of the examination is contained in DNV report no. 97-1378, amendment no. 01. The report draws the following conclusions:

- The tie bolt has failed due to a fatigue fracture initiated from several locations on the flanks of the thread profile.
- The examination shows that the fracture has been initiated at cold lap defects formed during the manufacturing of the threaded portion of the tie bolt.
- The microstructure, the chemical analysis and the hardness were as expected.
- No indications of significant torque irregularities having contributed to the failure were found."

These conclusions have been countered in part by Eurocopter, which is of the opinion that the first initiation point is outside the zone with defects in the threaded section.

1.16.4.6 *Attachment of main rotor blade*

As early as the day on which the accident occurred, a complete, almost undamaged, main rotor blade with its blade sleeve was found floating on the sea (see subparagraph 1.12.2.7). Since it was important to establish what caused the blade to fall off, it was immediately sent to DNV for examination. The examination showed that the blade sleeve with its associated yellow blade had separated from the blade spindle. The slotted nut had left the blade sleeve without significantly damaging the threaded section or the blade sleeve. All four retainer lugs, intended to prevent the slotted nut from rotating, were bent up to almost 90°. Examinations of an associated pitch change rod showed that it had been torn into two parts due to overload.

On the basis of the observed pattern of damage, DNV has not been able to provide any explanation as to why the blade sleeve was able to separate from the blade spindle. The examination is discussed in DNV report no. 2000-1121. For further details, please see subparagraph 2.2.10.

1.16.4.7 *Examinations of four splined sleeves removed due to suspected failure*

The accident involving LN-OPG led to an increased focus on the splined sleeves. After the accident, the AAIB/N received four splined sleeves from HS which were assessed as being non-airworthy for a variety of reasons. These were supplied to DNV for examination. The results are discussed in DNV report no. 99-1018 with its associated

Appendix A. The four splined sleeves are discussed below (numbers in parentheses refer to the DNV report).

On 29 September 1997, a splined sleeve was removed because of damage to the front of the cylindrical section. There was a suspicion of possible crack formation in the area. The examination at DNV concluded that no cracks were found in the area (splined sleeve no. 3).

On 27 October 1997, a splined sleeve was removed because of the suspicion of cracks in connection with two cases of damage previously worked on, in the front of the cylindrical section. The examination at DNV showed that one of the areas of damage had cracks in the hardmetal coating, but that the other area was free from cracks (splined sleeve no. 2).

On 2 January 1998, a splined sleeve was removed due to a suspicion of cracks, in connection with an area containing damage previously worked on in the front of the cylindrical section. A dye penetrant inspection performed by HS, in accordance with the helicopter manufacturer's maintenance procedures, did not disclose any cracks. An introductory examination at DNV using a microscope showed that a series of cracks was visible in the area at a magnification of X 10. An examination in the SEM showed that there were 26 cracks altogether in the hardmetal coating (see fig. 54). It was found that most cracks moved radially through the hardmetal coating without penetrating down into the base material. However, fig. 55 shows a crack toe that did go down into the base material (splined sleeve no. 1).

A splined sleeve that had been rejected during an inspection at Cougar Helicopters was sent to DNV via HS for examination. The part had sustained damage to the surface in two separate places forward on the cylindrical section of the splined sleeve. A series of cracks went from these into the hardmetal coating. The examination disclosed that the hardmetal coating had peeled off in two places and that this and the cracking were caused by an applied mechanical load. Fig. 56 shows one of the areas involving peeling (splined sleeve no. 4).

A number of irregularities in the hardmetal coating were found on the R/H splined sleeve from LN-OPG. It was therefore decided to use the four splined sleeves referred to above as a reference with regard to the general character of the surface coating. DNV draws the following conclusion:

"The depth of the hardmetal coating on the spline flanks are found to be from slightly to significantly below the specified minimum value. General mechanical service wear may be a contributor to this deviation. However, from the geometry of the coating surface, it is found most likely to believe that the depth of the flank coating has been below the specified minimum value already from the manufacturer.

Extraordinary large grains of tungsten carbide and local laminations have been seen for the spline coating of sleeve No. 1."

In addition, the following is quoted from DNV report no. 99 1018, Appendix A:

"None of the spline flanks examined in detail by DNV have showed a configuration of longitudinal coating scores and "grinding pattern" like the one found on the failed sleeve from the wrecked helicopter LN-OPG.

However, for one of the sleeves in question, some individual, longitudinal scores have been noted. These scores are found to fully penetrate the depth of the hardmetal surface coating."

1.16.4.8 *Examination of the firewall between the main gearbox (MGB) and R/H liaison tube*

A firewall is located between the exhaust pipe/liaison tube and the MGB. A part of this wall is riveted to a flange that is fixed between the liaison tube and the MGB. To gain access, this wall (access panel) can be removed when the tie-bolts are removed and the engine is shifted forward (see fig. 6).

During an examination of the mating flanges between the MGB and the R/H liaison tube, two rivet heads was found lodged between the firewall flange and the MGB. More rivet heads were found loose along this flange, and this damage is a result of the loads that arose when the firewall was torn off the flange during the accident. Fig. 73 show the flange as it was found. The picture shows several failed rivets. Holes left by the two rivets mentioned above is marked A and B respectively. The two rivet heads (flush headed) were stuck on the flange and left dimples in the material when they were removed. The dimple originating from head A is distinct on the picture fig. 74. Equivalent dimples were found at the mating surface on the MGB. The parts were handed to DNV for further investigation.

The investigation revealed that the two rivet heads were hammered so that they became lens-shaped (see fig. 75). A dimple in the flange was investigated, but it was not possible to find traces of fretting in it. However, it was found fretting/fretting corrosion on the mating surfaces on the liaison tube, and considerable amounts of corrosion on the firewall flange and the MGB mounting flange. It was found traces of fretting at the three dowel pins that together with the tie-bolts holds the liaison tube in position. This indicates that there has been relative movement between the liaison tube and the dowel pins/MGB. The investigation of the tie-bolts revealed that they were bent and stretched to a length of 198.4 mm, 202.2 mm and 202.8 mm respectively.

1.16.5 Tests, calculations and examinations carried out at Eurocopter

1.16.5.1 *Introduction*

The accident led to several examinations being carried out in collaboration between the AAIB/N, the French Bureau Enquêtes - Accidents (BEA) and the helicopter manufacturer (ECF). The finding of fatigue fractures in the splined sleeve and the splined flange focused attention on the loads and dynamics in the coupling between the Bendix shaft and the MGB. This became even more relevant when it became clear that the O-ring on the R/H splined sleeve was missing. ECF put a considerable emphasis on

this circumstance because experience from 1985 had shown that the O-ring had a damping function on vibrations in the Bendix shaft. To raise the level of knowledge concerning the damping function of the O-ring, and to chart the general behaviour of the power transmission during operation, ECF decided to carry out a test. The AAIB/N participated in this work, and a test programme was decided on in a meeting between ECF and AAIB/N in September 1998. The test was to be carried out by ECF on condition that the AAIB/N had full insight into the process and was continuously updated with the results.

Apart from results from the test, the AAIB/N was given access to other examination results and calculations performed by ECF. This includes results of examinations of parts from LN-OPG which had been previously examined by DNV.

1.16.5.2 *Test of movement between the splined sleeve and the splined flange*

ECF wanted to carry out the test to ascertain the relative movement between the splined sleeve and the splined flange under varying conditions, as well as the effect on this of the O-ring. The test was carried out on a standard MGB which was mounted in one of their test cells. A Bendix shaft was mounted on the gearbox. It was powered by the test cell at the engine end. A bracket was mounted on the splined flange by means of the same bolts that hold the Bendix shaft and splined flange together. A total of five sensors were mounted against the bracket so that three recorded axial movement and two recorded radial movement (see fig. 57). All of the parts involved had the same modification status as the parts on LN-OPG. The test was performed without it having been possible to simulate the relative movements that arise between the engines and the MGB in a helicopter in flight. The following parameters were included in the test:

- variations in torque
- with and without O-ring
- with and without the lubricant, Molicote G Rapid +
- with new and worn splined flange
- inline and with an angle between the Bendix shaft and the MGB
- with standard and worn 8 000 RPM wheel (the L/H 8 000 RPM wheel from LN-OPG was used for this)

Early on, it was clear that the processing and understanding of the data recorded was going to be demanding. The test results were further limited by the fact that ECF was not successful in obtaining signals from the two accelerometers that measured radial movement. The following are among the results from the test:

- The splined flange moved in relation to the splined sleeve with a base frequency equivalent to one movement per revolution.
- The test only gave relevant information for tilting (angling) of the splined flange in relation to the splined sleeve. The test did not produce measurements for axial or radial movements.

- No variations in tilting were measured in relation to variations in torque.
- No variations in tilting were measured with regard to whether the drive train was inline or at an angle.
- The wear on the 8 000 RPM wheel did not affect the test results.
- To simulate wear, the internal dimensions of the splined flange were increased by 0.4 mm. This resulted in a considerable increase in the movements measured.
- The test's maximum tilt was achieved during the test configuration with the worn splined flange, without O-ring and without lubricant on the splines. The splined flange then tilted to an angle of 5'. With the selected wear value of 0.4 mm, this is the maximum tilt that can arise before the movement is limited mechanically.
- Lubricant reduces the tilting.
- The smallest tilt was achieved with the new splined flange, the O-ring and lubricant. By removing the O-ring, the tilting increased by a factor of 1.2.
- If the splined flange was "worn" by 0.4 mm, with the lubricant in place and the O-ring removed, the tilt increased by a factor of 2.25.

1.16.5.3 *Calculations*

After the accident ECF carried out several calculations in order to increase understanding of the loads and safety margins applicable to the coupling between the Bendix shaft and the MGB. These were mainly based on material properties and Finite Element Method (FEM). ECF has presented to AAIB/N calculations of the loads on the input pinion, splined sleeve and splined flange (see fig. 58). The calculations, as they were presented, concluded that a theoretically perfect splined flange, which was the weakest link in the chain, had a safety factor of 22 against fatigue.

However, it was possible to reach the limit for incipient fatigue on the splined sleeve under the following conditions:

- wear on the parts that allow a tilt of 10' between the splined sleeve and the splined flange, and which thus lead to stress concentrations
- fretting
- damage to the hardmetal coating.

In addition, ECF supplied the information that torque modulations in the coupling between the Bendix shaft and the MGB were usually within the size range +/- 8%.

1.16.5.4 *Examination of the splined sleeve from LN-OPG*

After completion of the work at DNV, the splined sleeve was examined by ECF in the factory laboratory. The AAIB/N was informed that the findings made were in agreement with the examination results from DNV. ECF also performed a count of

lines (beach marks) in the fatigue fractures on the splined sleeve. By taking into consideration the different routes that the cracks could have followed, they ascertained that the cracking might have taken place along a route that covers a minimum of 79 lines.

1.16.5.5 *Examination of the R/H input pinion from LN-OPG*

After the work was completed at DNV, the input pinion was examined by ECF in its own laboratory. The AAIB/N has not succeeded in obtaining firm measurement results from this examination. However, information has been supplied that the surfaces of the teeth were rough, and that this could explain the wear on the R/H 8 000 RPM wheel.

1.16.5.6 *Examination of the R/H 8 000 RPM wheel from LN-OPG*

The R/H 8 000 RPM wheel (M541) was first visually examined by the AAIB/N in collaboration with a representative of ECF. This disclosed no signs of abnormal wear. Later, the part was examined by ECF in its own laboratory. The following are included in the measurement results from this examination:

- Several tooth profiles were worn on their active surface by approx. 0.030 mm. The maximum measured deviation in relation to construction drawings was 0.054 mm. According to the control criteria for production, the maximum profile error is 0.010 mm.
- Measurements along the teeth (helix) displayed wear of approx. 0.010 mm, with the greatest wear in the middle of the active tooth surface. This wear was measured in addition to a production deviation of an average of approx. 0.012 mm. The maximum deviation in relation to the construction drawings along an active surface was therefore measured at 0.030 mm. According to information supplied by ECF, the control criterion during production is 0.012 mm for helix error.
- Measurements of pitch variation (variation of the distance between the teeth) showed that the variations were within the control criteria during production, measured on the passive surface of the teeth. In measurements on active surfaces, however, accumulated pitch variations of a maximum 0.028 mm were found and individual pitch variations of a maximum fop 0.019 mm and fop 0.031 mm. According to the control criteria on the construction drawings, the requirements for these should be within 0.024 mm and fop 0.008 mm and fu 0.012 mm, respectively. These measurements were carried out at three different locations on the teeth and the result from the measurements in the middle of the teeth are graphically illustrated in fig. 59.

1.16.5.7 *Examination of L/H 8 000 RPM wheel from LN-OPG*

The L/H 8 000 RPM wheel (M921) was examined by ECF in its own laboratory. Measurements of tooth profile and helix showed that there had been only an insignificant deviation. The wear on the tooth profiles could not be measured. The

maximum deviation measured on the helix was 0.008 mm. Pitch error was not measured.

1.16.5.8 *Examination of coating on overhauled splined sleeve*

ECF examined a splined sleeve which had been operating for approx. 3 000 hours and which was then overhauled at the factory. A report that was supplied to the AAIB/N concludes that the coating had an average thickness of 27 µm and that the status of the coating was satisfactory. The thickness of the coating was still found to be within the tolerances.

1.16.5.9 *Dimensions concerning the O-ring*

Parts have the permitted production tolerances. In particular the depth of the groove in which the O-ring is located and the dimensions of the O-ring are crucial to its damping function. ECF provided the information that, with the thinnest O-ring and the deepest groove, the O-ring would project 0.27 mm above the surface of the splined sleeve. In the opposite case, with the thickest O-ring and shallowest groove, it would project 0.52 mm above the surface.

1.16.6 Examination of the engines at Turbomeca

1.16.6.1 *Introduction*

After an external visual examination by AAIB/N, the engines, apart from the liaison tube, were sent to Turbomeca at Bordes in France for more detailed examination. The engine EECUs were also sent to the same location. The examination at Turbomeca were performed together with representatives of the BEA and the AAIB/N. The result of the examinations is described in Turbomeca report no. 1 491, dated 29 September 1997 (the EECU and Overspeed Fuel Shut-off Valve) and Turbomeca report no. 937D dated 23 February 1998 (see fig. 3 for a description of the engine).

A short report of the findings on the engines follows below:

1.16.6.2 *L/H engine*

The gas generator section had considerable traces of rubbing from contact between stationary and rotating components. The axial compressor's rotating parts had considerable damage from foreign objects that had entered through the air intake while the engine was rotating at high speed. Apart from some corrosion, all bearings were found to be in good condition.

The turbine housing for the power turbine had been powerfully compressed at the 3 o'clock position, viewed from behind. The housing also had a fissure along approx. 180° of the circumference (see fig. 15b). The lips along this fissure were bent out of the housing from the 11 - 1 o'clock position. From 1 - 3 o'clock, the lips pointed in to the centre, and from 3 - 5 o'clock these pointed outward again. The containment rings of the turbine had also failed in the area of the fissure. Only the outer race of

bearing no. 5 remained in the bearing housing. The turbine with the front part of the turbine shaft was missing so that only the output shaft remained in bearing no. 6. The Curvic coupling on the output shaft was completely worn down and destroyed by hammering. The turbine's tie-bolt was cut on a level with the Curvic coupling. Bearing no. 6 rotated easily, despite corrosion starting to attack.

The phonic wheels had marks of wear from contact with the speed sensors, but the wear was found to be within the tolerance requirements specified. This wear was unevenly distributed along the radius of the wheels. The Bendix shaft was found firmly fixed to the turbine shaft, and was without visible damage. The liaison tube still remained in the bearing housing for bearing no. 6, but the three tie-bolts at the attachment to the MGB had broken loose so that the entire power turbine section had separated from the gearbox. The liaison tube was buckled on the underside rear at the MGB flange, and this was combined with the tube being slightly bent down in the same area. Both speed probes were found correctly mounted in their grooves. All speed sensors had wear marks from contact with the phonic wheel. The wear indicates that there had been axial movement between the phonic wheel and the speed probes. In general, the wear was greatest on the rear speed sensors. A test of speed probe no. 2292 showed that all speed sensors were supplying signals within their tolerance requirements. Speed probe no. 2293 was not issuing any signals during the test.

The engine's Overspeed Shut-off Valve was examined and tested at Turbomeca. It was established that the component was working satisfactorily. The EECU was also examined without any fault being established that could have had any significance to the course of events. In addition, it was established that the unit's overspeed protection function had not actuated.

1.16.6.3 *R/H engine*

The gas generator section had little damage after the accident. The pattern of damage indicated that the engine had been rotating at a low RPM when the helicopter hit the surface of the sea. Apart from some corrosion, all of the bearings were found to be in good condition.

The turbine housing for the power turbine was split in two on a level with the turbines. The lips along the fissure were bent outward in an even pattern on both halves (see fig. 16). The containment rings of the power turbine were completely missing. Only the outer race of bearing no. 5 remained in the bearing housing. The turbine with the forward part of the turbine shaft was missing so that only the output shaft remained in bearing no. 6. The Curvic coupling on the output shaft had some teeth that were completely intact and other teeth that were missing or badly damaged. The turbine's tie-bolt was cut on a level with the Curvic coupling. Bearing no. 6 was considerably corroded. An examination of the outer bearing race disclosed overload damage. However, there were no signs of wear or imbalance in the bearing. An examination of the forward labyrinth seal (part no. 0.298.80.214.0) for bearing no. 6 showed that the diameter of the rotating part had increased by 27 μm , which corresponds to the increase that might be expected at a turbine speed of 130 - 197% *Nf*.

The phonic wheels had marks of wear from contact with the speed sensors, but the wear was found to be within the tolerance requirements specified. This wear was unevenly distributed along the radius of the wheels and was such that the rear wheel exhibited greatest wear. The forward part of the Bendix shaft and the liaison tube were found firmly mounted on the engine. Both speed probes were found correctly mounted in their grooves. All speed sensors had wear marks from contact with the phonic wheel. This wear indicated that there had been relative axial movement between the phonic wheel and the speed probes. In general, the wear was greatest on the rearmost speed sensors. The results of tests and measurements on speed probes no. 2036 and no. 2018 are shown in fig. 61. A test of speed probe no. 2036 showed that all speed sensors were supplying signals within the tolerance requirement. However, speed probe no. 2018 only gave signals from one speed sensor.

The engine's Overspeed Shut-off Valve was examined and tested at Turbomeca. It was established that the component was working satisfactorily. The EECU was also examined without it being established that there was any fault that could have been of any significance to the course of events. In addition, it was established that the overspeed protection function of the unit had not actuated.

1.16.7 Examinations of components from AS 332L1 main gearboxes at HS

1.16.7.1 *Introduction*

The AAIB/N wanted to obtain an overview of the methods used in the inspection of gearbox components during overhaul at HS. The R/H and L/H 8 000 RPM wheels and the R/H input pinion were therefore examined at the component workshop at HS in collaboration with the workshop staff. The components mentioned were checked in accordance with the same criteria as corresponding components for overhaul (see subparagraph 1.6.6.2). The results are described below.

1.16.7.2 *R/H input pinion from LN-OPG*

The teeth on the R/H input pinion were found to be in good condition with no traces of visible wear or damage. Apart from some traces of corrosion, the teeth could have been released for service without further control measurements or assessments. Control measurements were taken on two different teeth at three different locations on the teeth, which produced the following results (measured using 5 mm dia. pins in accordance with MRV 63.28.10.820) cf. figure 8:

- front 82.545 mm centre 82.601 mm rear 82.590 mm
- front 82.564 mm centre 82.594 mm rear 82.599 mm

The result should be within the limits which are set at 82.556 mm - 82.642 mm. The underlined value is not within the limits. However, with the measuring equipment that was available, the accuracy of the last decimal point could be called into question.

1.16.7.3 R/H 8 000 RPM wheel from LN-OPG

The teeth on the R/H 8 000 RPM wheel were found to be in good condition with no traces of visible wear. Apart from some traces of corrosion and some dents, the teeth could have been approved without further control measurements or assessments. Control measurements at three different locations on the teeth in two different positions produced the following results (measured using 5 mm dia. pins in accordance with MRV 83.28.10.820, see fig. 8):

- front 218.549 mm centre 218.509 mm rear 218.509 mm
- front 218.539 mm centre 218.509 mm rear 218.504 mm

The result should be within the limits which are set at 218.519 mm – 218.621 mm. Underlined values are not within the limits. With the measuring equipment that was available, the accuracy of the last decimal point could be called into question.

1.16.7.4 L/H 8 000 RPM wheel from LN-OPG

The teeth on the R/H 8 000 RPM wheel were found to be in good condition with no traces of visible wear. Apart from considerable corrosion and some dents, the teeth could have been released for service without further control measurements or assessments. Control measurements taken at three different locations on the teeth produced the following results (measured using 5 mm dia. pins in accordance with MRV 83.28.10.820, see fig. 8):

- front 218.584 mm centre 218.592 mm rear 218.592 mm

The measurements showed that the teeth are within the given wear limits.

1.16.8 Calculations carried out by SINTEF

To get an independent evaluation of central splined sleeve properties SINTEF was contacted. Even small defects can influence the fatigue behaviour and thereby initiate cracks, consequently the surface microtopography was investigated. Segments of splined sleeve (see subparagraph 1.16.4.7), DNV reports 98-1118 rev. 01, 99-1018 rev. 01 and material properties (Characteristiques mecaniques statiques, Determination de la courbe de Wohler et Fissuration en fatigue) was handed to SINTEF. Details from pictures in the DNV reports were measured to get information about surface microtopography. 16 different areas were investigated. Depth, radius of pit tip, length of individual measurements and possible particles in the pits was registered. FEM was then utilised to find the fatigue limit. The calculations were based on empirical data from SINTEF.

The following material properties were utilised:

UTS		1 117 MPa
R _{0.2}		1 020 MPa
Endurance limit R = -1		$\Delta\sigma_E/2 = 495 \text{ MPa}$
Threshold values (lower boundary)	R = 0.5	$3.5 \text{ MPa} \cdot \text{m}^{1/2}$
	R = 0.1	$6 \text{ MPa} \cdot \text{m}^{1/2}$

The deepest pit that was measured on the splined sleeve from LN-OPG was 14 μm . The pit radius was 1 μm . Based on FEM this gives a local fatigue limit ($\Delta\sigma_E/2$) of $\pm 270 \text{ MPa}$. SINTEF could not exclude the possibility that even deeper pits exist on the component. The fatigue limit will be approximately $\pm 160 \text{ MPa}$ with a pit dept of 100 μm .

The transition from a tip crack initiation model to a fracture mechanical model was at 100 μm .

1.16.9 Other examinations of rotating components in the main gearbox (MGB)

1.16.9.1 *Balance checks*

The AAIB/N received information that there had been problems with imbalance in shafts and gears in main gearboxes on AS 332s belonging to the Swedish Armed Forces. The AAIB/N got in touch with the Armed Forces and was informed about an examination that was carried out by the company, Celsius. The examination was implemented on the basis of there being problems in coming within stipulated limit values for vibrations during test running of the MGB on the test bench. In addition, there had been problems with short working lives for bearings inside the MGB. The AAIB/N had a report forwarded from Celsius. The results of the balance checks are presented as G-grades (Quality Grade in compliance with International Standard ISO 1940/1). In tabular form, ISO 1940/1 gives an overview of the rotating parts that normally belong within the various quality grades. The table lists items such as gyros as G-grade 0.4 and small electric armatures with special requirements in G-grade 1. Examples from G-grade 2.5 include items such as computer memory drums and discs and turbo-compressors. Assembled aircraft gas turbine rotors are listed as G-grade 6.3. Agricultural machinery is named as G-grade 16 and car wheels, for example, are listed as G-grade 40. See fig. 5 for components in the MGB.

The list below shows some of the results of the examination:

- 7 ea. input pinions G-grades from G 3.7 - G 8.1
- 8 ea. 8 000 RPM wheels G-grades from G 4.25 - G 5.4
- 6 ea. free wheel gears G-grade from G 14 - G 78

On the basis of the report from Celsius, the AAIB/N decided to undertake a check of some of the components in the MGB from LN-OPG. The work was carried out at the Norwegian Air Force Main Depot [Luftforsvarets Forsyningskommando] (LFK) at

Kjeller with a balancing machine of the LUD 0074-ARD 0614 type. The parts were checked at speeds of 1 140 - 1 676 revolutions per min. During the work, International Standard ISO 1940/1 was used as a reference. The following components were checked:

Name	Greatest imbalance	Quality grade
L/H splined sleeve (damaged)	4.66 g	G 6.3
L/H input pinion	1.19 g	G 2.5
R/H input pinion	0.089 g	G 0.4
L/H free wheel shaft	0.637 g	G 0.4
R/H free wheel shaft	0.246 g	G 0.4
L/H 8 000 RPM wheel	0.488 g	G 0.4
R/H 8 000 RPM wheel	0.240 g	G 1
L/H free wheel gear	1.34 g	G 0.4
R/H free wheel gear	2.87 g	G 0.4
L/H torquemeter shaft	2.12 g	G 1
R/H torquemeter shaft	2.94 g	G 1

The MGB (serial number M463) from the Swedish helicopter that was involved in the incident on 16 June 1998 was sent to ECF for extensive examinations, including balance checking. The AAIB/N has obtained access to the following balancing data:

- R/H input pinion 14 gmm between G 16 and G 40
- L/H input pinion 8 gmm G 16
- R/H 8 000 RPM wheel 15 gmm between G 6.3 and G 16
- L/H 8 000 RPM wheel 12.5 gmm between G 6.3 and G 16

ECF has confirmed to the AAIB/N that, during manufacture of the components, balancing is only carried out on the input pinion and the 8 000 RPM wheel in the MGB.

1.16.9.2 *Measurements*

On commission from the AAIB/N, the Norwegian Air Force Main Depot performed measurements on the R/H 8 000 RPM wheel. The component was measured in a co-ordinates gauging machine with regard to roundness - concentricity. The measurements showed that the component was within production tolerances with regard to these values.

1.17 **Organisational and management information**

1.17.1 Civil Aviation Authority – Section for Aviation Inspection

- 1.17.1.1 Before 1 January 2000, there was one regulatory body for civil aviation in Norway, the Norwegian Civil Aviation Authority [Luftfartsverket]. This was then split into the Norwegian Civil Aviation Administration [Luftfartsverket] and the Norwegian Civil

Aviation Authority [Luftfartstilsyn]. Up until 1 January 2000, the Section for Aviation Safety at the Norwegian Civil Aviation Authority was the safety authority. As a result, the Section for Aviation Safety at the Norwegian Civil Aviation Authority had, at the time of the accident, overall responsibility for standardisation and regulation frameworks, initial surveillance for authority approval and company inspection. Initial surveillance for authority approval of applicants to the civil aviation industry covers the issue of licences, operating permits and certificates (also defined as systems or parts of a system). Company surveillance must ensure that the given terms and conditions continue to satisfy the regulatory authority after admission to the civil aviation industry has been granted. Among other things, this means that the authority approves the safety standard described via the individual aviation company's system of manuals as required by the authority, and carries out inspections to ensure that this standard is being maintained by the aviation company. The safety standard must be based on the regulations at least, but may also contain the company's own and stricter requirements plus client requirements. Surveillance of operations involve individual inspectors at the authority having a number of aviation ventures (companies) as their dedicated areas. Annual inspections (aircraft operations and technical department) of the respective companies are also carried out.

- 1.17.1.2 To obtain an impression of the initial surveillance for authority approval and the inspection of operations which the civil aviation authorities undertook at HS during the period 1990-1997 (as at 8 September 1997), and to identify the prominent topics, the AAIB/N have, on request, had current documentation transmitted from the NCAA. The documentation shows that the following was carried out during the period:

3 initial surveillances for authority approval, technical department

2 joint technical department/aircraft operations inspections

9 technical department inspections

4 aircraft operations inspections

In 1992, no technical department inspection was documented

In 1993 and 1995, no operational inspection was documented

Workshop operations were approved in accordance with JAR 145 in 1993.

- 1.17.1.3 In March and July 1997, surveillance of the operator's technical department was carried out by the authority, of which the last part was a combined Norwegian/American (FAA) inspection. Because these inspections of operations were carried out within the last year prior to the accident, the AAIB/N concentrated on these in particular. The reports on both of these inspections contain highly critical comments in places:

Report 97J007

"The workshop has established routines and procedures, which are highly detailed and comprehensive for the activity being performed. On the basis of this report, it can nevertheless be established that there has to be a change of

attitude among the employees to ensure that workshop routines and procedures are adhered to. As regards the observations on the stores in this report, the NCAA would like to give a reminder that several of these circumstances were pointed out by the FAA during their last inspection." (Translated from original Norwegian)

Report 97J095

"The workshop has established routines that cover most of the activities. On the basis of the number of observations that were found during the inspection, it has been shown, however, that the employees' knowledge of procedures and regulations is not satisfactory. It also appears that there must be a change of attitude among employees at all levels in the company. The observations in this report must be regarded as symptoms indicating that procedures, attitudes, knowledge and responsibility for work carried out can and must be improved.

The workshop management, headed by the manager of the technical division, is responsible for necessary resources being made available so that corrective measures are implemented and followed up. The workshop's quality system is a very good tool that should be used for this purpose.

The disquieting thing is that several of the circumstances observed during this inspection are circumstances that have been observed previously in internal review reports, in addition to the NCAA and FAA having observed similar circumstances in their inspection reports. The NCAA takes a serious view of this and would like to issue a reminder that it is the full and entire responsibility of the accountable manager to ensure that the operation functions in accordance with the regulations. (Ref. Accountable Managers Statement in MOM Chap. 00-00-05). It is also necessary for improvements to be implemented, considering the company's plans for closer collaboration with other operators as regards maintenance of components and aircraft, and its plans for a further expansion of the fleet of aircraft.

On the basis of this report, the NCAA will be carrying out a follow-up inspection of the workshop at a later date." (Translated from original Norwegian)

The two reports contain a total of 106 observations.

- 1.17.1.4 In accordance with BSL B 3-2, the maintenance of aircraft materiel must be undertaken in accordance with a system that has been approved by the civil aviation authorities. Among other things, owners/users of aircraft of the type operated by HS are required to be maintained in accordance with a programme approved by the authorities. The maintenance programme must be based on the aircraft manufacturer's recommended programme. In this way, the maintenance programmes for the respective helicopter types within HS will be approved by the civil aviation authorities in accordance with BSL B 3-2.

1.17.2 Helikopter Service AS

1.17.2.1 From a modest start in the mid-1950s, the company has developed into a dominant transportation company in the context of the Norwegian offshore industry. This process has involved being acquired by, and also acquiring, other companies. Braathens Helicopters, Mørefly AS and Luftransport AS are examples of Norwegian acquisitions. The company has also become internationalised via considerable interests in Bond Helicopters in the UK, Lloyd Helicopter in Australia, Court Helicopters in South Africa and contracts in Asia, for example. At the time of writing, the company has been taken over by Canadian Helicopter Corporation.

1.17.2.2 The company's main base is situated at Stavanger Sola Airport, where light maintenance (line maintenance), heavy maintenance (base maintenance) and the overhaul of equipment and components (workshop maintenance) are carried out. Light maintenance is performed at approx. 10 secondary bases (line stations) domestically, offshore and overseas. Brønnøysund is an example of a typical line station. The civil aviation authorities must approve all line stations.

HS itself operates around 23 helicopters in an offshore context and leases approx. 23 helicopters to other operators.

The organisation of technical division at the company is shown in the enclosed organisation diagram (see fig. 62).

1.17.2.3 At the time of the accident, the company had the following authority approvals:

Licence for the performance of commercial air transportation No. 051

Air Operators Certificate, AOC No. CAA-N 051

Permit to operate commercial aviation activities (not covered by AOC)

Maintenance System Approval (BSL D 2-12 and BSL B 3-2)

JAR 145 Maintenance Approval

The American Federal Aviation Administration (FAA) has given the company a Foreign Repair Station certificate (Air Agency Certificate No. CZ5Y797M)

The company also possessed maintenance certificates from the Sultanate of Oman and the Republic of Indonesia.

1.17.2.4 The company's manuals structure is based on the principle of strategic level (1), tactical level (2) and operational level (3) in which the Quality Manual represents the strategic level. The company has chosen NS-EN ISO 9001 as its quality standard. The quality system of the technical division is documented by way of seven manuals (tactical level), the Maintenance Operations Manual (MOM) and six Procedures Manuals (PM). (TD - Technical Data, QA - Quality Assurance, L - Logistic, P - Planning, MR - Maintenance Records and M - Maintenance). Maintenance programmes, work descriptions plus results documentation and reference manuals are examples of the operational level.

1.17.2.5 In addition to the previously mentioned manuals, the company has informed us that they use a series of fixed, predictable routines in their management process of the technical division:

- Technical management meetings, in a fixed programme: Quality – operations – financial.
- Daily “service meetings” – telephone meetings between technical management and the line stations each weekday morning (Monday – Friday) 08.00 hrs, focusing on currently relevant situations in the company.
- Monthly information meetings (last Wednesday in each month, 14.00 to 15.00 hrs) for all employees in Stavanger. Has a fixed agenda: Quality – operations – financial – development.
- Regular information meetings for employees at the other bases.
- Regular presence of technical management at the line stations – considered attitudes and consistent implementation.
- Well built out and regularly used information systems.
- A systematic programme of skill-building and training, in which training requirements are consistently implemented.
- Reporting and processing of non-conformances and systematic review of approved corrective measures.
- A system for reliability review (Maintenance Review Board) based on quarterly reliability reports for each helicopter model, in which the NCAA - Section for Aviation Inspection (now the Norwegian Civil Aviation Authority) participates with the company’s operational management – a process that has led to an “unending” series of improvement measures – modifications, changes to the maintenance programme, information, training, etc.
- The technical division has emphasised to the AAIB/N that they have been involved in a process of management development, with participation from several levels in the organisation, for several years. In addition, both aircraft technicians and technicians have been directly involved in comprehensive improvement processes that have yielded extremely good results.

1.17.2.6 The AAIB/N has undertaken a thorough review of the technical division’s documented quality system. Further information can be found in chapter 2.7.

In connection with an accident in 1996, the AAIB/N undertook a similar review of the technical division’s documented quality system. This is described in AAIB/N report no. 2/98.

1.18 Additional information

1.18.1 Maintenance of aircraft materiel

1.18.1.1 *Description of the maintenance system used at HS*

The helicopter was maintained on the basis of maintenance instructions developed by the manufacturer, Eurocopter. As a user, HS has developed its own maintenance system based on the maintenance instructions prescribed by the manufacturer and on the Norwegian civil aviation regulations and its own practical experience. This will be described below in more detail.

Eurocopter describes the helicopter's maintenance programme in Master Servicing Recommendations (abbreviated to PRE by Eurocopter). The various maintenance tasks that are to be carried out are described in Eurocopter Maintenance Manual (abbreviated to MET by Eurocopter). Eurocopter has also developed a system in which the work tasks in MET are displayed on job cards with references to enclosed figures and tables. These are described as Work Cards or just W.C. The various work tasks and areas are described using a numbering system based on the ATA 100 (Air Transport Association of America) standard.

The company's maintenance programme is described in the Maintenance Requirements Manual (MRM). The NCAA has approved this manual. As mentioned above, this programme is to a great extent based on the maintenance instructions from Eurocopter. The various tasks of work described by the MRM are inserted into a computer tool - the Maintenance Requirement System (MRS). This computer tool is used in monitoring maintenance tasks and the status of the helicopter and its associated components. A variety of information and lists are procured by means of this computer tool. Some of these are described below:

- Maintenance Requirement List (MRL). This constitutes part of the MRM, and is an ongoing summary of the maintenance programme which can be printed out in the form of a computer listing. This listing does not contain any maintenance tasks which are to be carried out on a daily basis or at intervals of below 40 flying hours Requirement Status List. This list provides a summary of the various maintenance tasks with regard to interval, the time of the last compliance and the next time the maintenance task should be carried out. All maintenance tasks have a number specified by HS (MRS no.)
- Maintenance Requirements Information. Information regarding the individual maintenance task with regard to reviews and intervals etc. The information is used in particular during the definition of maintenance tasks. This type of information sheet can be printed out for each MRSno.
- When one or more maintenance tasks are to be carried out in accordance with the Requirement Status List, the maintenance tasks can be printed out as a Work Pack, Work Specification. The form which is then produced contains a description of the work that is to be carried out with references to

maintenance manuals and routines etc., and with columns for the entry of maintenance data and signatures. After one or more Work Packs, Work Specifications have been carried out together, these are collected behind a front page that contains common supplementary details (Work Pack Front Page).

- **Print-out of Complaints.** This is a list of the technical faults and deviations that have been reported. The list can be sorted, for example, according to areas and systems (ATA), periods or individual helicopters.

According to the company's Procedures Manual - Technical Data (PM-TD) chapter 01-23, the responsibility for the maintenance programme that is to be used, lies with the respective section engineer. The actual content of the programme must be written by a programme engineer. As mentioned above, this programme is based on PRE, but Airworthiness Directives (AD notes), Service Bulletins (SB), Service Letters (SL), Civil Aviation Regulations (BSL) and the company's own requirements must also be taken into consideration and possibly incorporated into the programme. The following quotation can be made from PM-TD chapter 01-23, with regard to changes to an approved programme:

"B Maintenance program variation and updating.

Due to different reasons the several types of variations to the maintenance program may become necessary. For quality assurance purposes these variations can be grouped into minor and major variations:

Minor variations of maintenance program

- i. Changes of text description
- ii. Corrections of manual reference
- iii. Changes of maintenance requirements indexing (MR number)
- iv. Addition of new part numbers

Major variations of maintenance program

- v. Variations of maintenance intervals or limit tolerances
- vi. Changes of maintenance process
- vii. Significant changes of maintenance scope"

In addition, the following can be quoted from the same chapter:

"(2) Processing

All initiation of maintenance program changes will be evaluated by a program engineer. The basis for the change and the effect if any shall be documented. A record of all maintenance program changes shall be kept for further reference.

(3) Quality assurance

For minor changes of the maintenance program no additional approval is required. Major changes of the maintenance program shall be reviewed and approved by the type section manager. A print-out of all changes to the maintenance program shall be printed and reviewed by the section manager every week. All changes to workcards or forms in the MRM shall be approved by the type section manager."

Normally, the helicopter undergoes a Daily Maintenance Check (DMC) after the last flight of the day. On the basis of the DMC, a Daily Maintenance Record (DMR) is kept which confirms the airworthiness of the helicopter. Any faults or deficiencies found during inspection or otherwise during operations, and the measures which will be implemented, must also be entered into the DMR.

1.18.1.2 *Changes to the text ordering the inspection of the coupling between the Bendix shaft and main gearbox (MGB)*

The NDT inspection was part of an inspection that was to be carried out in accordance with requirements in the PRE specified by Eurocopter. Chapter 05.20.00 discusses the inspection as ENGINE-TO-MGB COUPLING - DETAILED CHECK with reference to MET CT 63.10.00.602 (see Appendix A). Below is a description of the way in which the inspection is described in the company's MRM, and the way in which the content changed over time in line with amendments of the text:

At Mørefly, the relevant inspection of the main gearbox input pinion and Bendix shaft took place in two separate inspections. These inspections were taken over and approved as a part of the maintenance programme at HS when LN-OPG was taken over. Relevant parts of the text that describe the two inspections are reproduced below.

"1T1-63-501"

"TASK ITEMS 4, PERFORM GENERAL CHECK OF ENG MGB COUPLING", with reference to "W.C. (63.10.00.602) EXCEPT PARA 3.3 & 3.4".

The inspection was marked "ISSUE NUMBER: 001. DATE REVISED: 25.09.93"

and

"1T1-60-400"

TASK ITEMS 1, VERIFY ENG. MGB COUPLING USING NDT", with reference to "W.C. (63.10.00.602) PARA 3.3 AND 3.4".

The inspection was marked "ISSUE NUMBER: 002. DATE REVISED: 25.04.94"

Some time later, the maintenance instructions were revised by HS. The relevant inspection is described on a "332L1 MAINTENANCE REQUIREMENT LIST" dated 10 October 1995 in the following manner:

"Perform removal/installation of Right Engine i.a.w. Main Task 72. Perform NDT of Right MGB input Sleeve i.a.w. MET 63.10.00.602, § 3.4. Record 23 000 RPM vibration level i DMR or WS....."

All paragraphs in the inspection apart from § 3.4 were, at this time, covered by "Main Task 72" (see Appendix C). This explains why the discussion of the general inspection of the coupling is not described in the text. Main Tasks were drawn up by the company to gather into one place all relevant information about some selected major maintenance tasks. This also contains references to the MET or other manuals, has open fields for the entry of measurement data and has columns for signing off each individual subtask. Main Task 72 (a later amendment is referred to as Main Task 72-3) was drawn up to cover the removal of an engine, necessary inspections of the Bendix shaft and the gearbox shaft input prior to assembly, and the actual installation of the engine.

In 1996, the MRM was transferred to the computer tool, MRS, and the relevant inspection was given a number (MRSno. 14887). A printout of amendment no. 01 of the Maintenance Requirements Information describes the inspection as follows:

"(Perform removal/installation of Right Engine i.a.w. Main Task 72) Perform NDT of Right MGB input Sleeve i.a.w. MET 63.10.00.602, para. 3.4."

As a part of MRS, the company introduced the system containing Work Specification/Work Pack as a means to order maintenance tasks. It was then decided as a general rule to refer directly to the Eurocopter Maintenance Manual (MET). The MRM was adapted for this. This was given expression on 14 September 1996 in amendment no. 03 of the Maintenance Requirements Information applicable to MRSno. 14887. The following is given as the foundation for the amendment:

"Minor. Text added in WP 25"

The text itself was given the following format:

- "REMOVAL OF RIGHT ENGINE
1. Remove Right Engine iaw MET 71.00.00.401
NDT OF RIGHT MGB INPUT SLEEVE
 2. Perform NDT of Right MGB Input Sleeve iaw MET 63.10.00.602, para. 3.4. Dock. ref: MET 63.10.00.602
INSTALLATION OF RIGHT ENGINE
 3. Install Right Engine iaw MET 71.00.00.401."

During this amendment, the order concerning the use of Main Task 72 was removed. After the accident, it was clear that the removal of this text meant that important parts of the inspection, which were previously covered by Main Task 72, were not performed. What remained was paragraph 3.4, and it only covered the NDT part of the inspection. A change in a maintenance instruction had therefore inadvertently led to a change in the maintenance programme as it was described in the MRM.

In this context, mention should be made of the fact that the text for the inspection of the R/H and L/H shaft inputs was not revised at the same time. Thus, the text for the L/H side (amendment no. 03 of MRSno 14885) was revised on 28 August 1996 in a corresponding manner. The following details were given as a foundation for the amendment:

"Major. Maintenance description corrected. Text added in work pack.
Tolerance changed from + - 10 to + 20"

The undesired consequences of these revisions were not discovered in the company despite the procedures for amendments and quality assurance described.

MRSno. 14887 was revised a further two times prior to its being used for the performance of the inspection of the coupling between the Bendix shaft and the MGB on LN-OPG in Brønnøysund. The text that describes the inspection remained unchanged, however.

1.18.1.3 *A summary of some relevant maintenance instructions for use during the inspection of the coupling between the Bendix shaft and the main gearbox (MGB)*

To show the complexity of the maintenance instructions that are to be used, a summary follows of the documents that are to be used in conjunction with the inspection to verify that the splined flange is within the inspection tolerances specified by ECF. Removal and installation of the engine must be carried out in accordance with MET 71.00.00.401. This contains the following references:

- 6 references to the Maintenance Manual
- 4 references to the Standard Practices Manual
- 1 reference to the Flight Manual.

The inspection that is carried out after the engine has been removed, must be carried out in accordance with MET 63.10.00.602. This contains the following references:

- 3 references to the Maintenance Manual
- 4 references to the Standard Practices Manual
- 2 references to the Repair Manual.

One of these references to the Repair Manual applies to MET 63.10.00.701 "Engine - MGB COUPLING Replacement of coupling shaft splined flange". This contains the following references:

- 1 reference to the Maintenance Manual
- 1 reference to the Standard Practices Manual
- 2 references to the Repair Manual.

One of these references to the Repair Manual applies to MET 63.10.00.726 which gives some of the wear limitations on the splined flange.

This list is not complete because it is based on the maintenance instructions supplied by ECF. As discussed in subparagraphs 1.6.6.6 and 1.18.1.1, HS has incorporated several additions and amendments into the maintenance system. It follows from this that there are further references in the maintenance instructions.

1.18.1.4 *Aircraft technicians - training in technical documentation*

Aircraft technicians (ICAO Type II) possess licences issued by the civil aviation authorities. At the outset, this licence confers the right to issue release-to-service for complete aircraft, and for components when required. The licence is issued on a personal basis and does not give unconstrained rights within an aviation company. The company can determine which internal guidelines are to be adhered to before a licensed aircraft technician is authorised to put into practice the rights covered by the licence. HS has decided that all licensed aircraft technicians must have internal training in the HS Quality Assurance system. In addition, all technicians who are given the right to issue Release-to-Service (Certifying Staff) must receive training in the "HS AS organisation and documentation system, the Civil Aviation Act, relevant BSLs and JAR 145." Licensed aircraft technicians undergo Continuation Training constantly in order to ensure that they are kept up to date as regards essential changes of a maintenance and organisational nature.

Maintenance personnel (who include licensed aircraft technicians) are responsible for the quality of their work by performing their activities in accordance with an approved standard and the organisation's steering documents, the Maintenance Operations Manual and the Procedures Manuals. In addition, when aircraft technicians are given authorisation as Certifying staff, they are required to:

"...thoroughly familiarise themselves with authority requirements (CAA-N, JAA, FAA and similar), Helikopter Service AS Technical Quality System as documented in the company manuals (the Maintenance Operations Manual and the Procedures manuals), the technical data, methods and techniques, applicable for their area of responsibility".

1.18.1.5 *The maintenance organisation at HS - some observations*

To gain a better insight into the maintenance organisation at HS, representatives from the AAIB/N held several conversations with employees in the company's technical

department during the period 16 - 23 June in 1998. The topics under discussion were of a general and theoretical nature, but specific maintenance tasks and details of the maintenance system were also reviewed. The AAIB/N held conversations with the technicians who carried out central maintenance tasks on LN-OPG, representatives of middle management and the top management of the technical department at the company. The conversations provided the basis for the descriptions of the maintenance on LN-OPG which are reproduced in this report. During the conversations, several circumstances emerged which the AAIB/N believes may have had an unfortunate effect on the maintenance work carried out in the company. This is described below, on a point-by-point basis:

- Several of those with whom the AAIB/N held conversations were not very familiar with the content of the documented quality system at the technical division. In some cases, they had difficulty in finding and explaining their own job description or procedures by means of the manuals.
- The purchase of other helicopter companies has brought in staff with long experience of the AS 332 Super Puma to the technical department at HS, but they do not have equivalent skills concerning the structure of the company's maintenance system.
- During the period prior to the accident, the procedures within the company had undergone considerable amendments. In particular, there was increasing use of electronic data processing and the introduction of the system involving Work Packs.
- There was a lack of certainty among some of the aircraft technicians regarding whether the relevant Main Tasks were to be used during the performance of maintenance tasks, or whether their use was optional. This was relevant in cases where Main Tasks was not listed as a reference document, or in cases where only parts of the text were relevant.
- The maintenance instructions are comprehensive and contain a great many referrals and references. This leads to the situation where even minor maintenance tasks require access to details from many sources.

1.18.1.6 *Demonstration of inspection of the coupling between the Bendix shaft and the main gearbox (MGB) at HS*

The AAIB/N is of the opinion that the maintenance work that was carried out in the splined sleeve area prior to the accident was particularly important. The AAIB/N was therefore given the opportunity to be present at an inspection of the coupling between the Bendix shaft and the MGB held at HS in the maintenance hangar at Sola. During the work, Main Task 72-3 was used. The R/H engine was first released and moved forward, then hoisted up to obtain better access to the splined sleeve. The splined sleeve and the splined flange were marked with ink so that they would mesh in the same way during re-installation. Then, an NDT technician performed a dye penetrant inspection of the splined sleeve.

As discussed in subparagraph 1.6.6.6, the inspection must be carried out in accordance with WC 20.02.09.101. This is a very general procedure for inspection when the component is installed in the MGB, and it provides limited information about the choice of the type of penetrant. HS therefore used the specifications given in the overhaul manual MRV 63.28.10.835 also during inspections when the component is installed in the MGB. This makes reference to IGC 04.25.100, which is a general French specification (equivalent to the MIL/ASTM standard). IGC states that "Materials not included in this IGC but included in QPL may be used". The Qualified Product List (QPL) is a list of products that are permitted for use, listed according to requirements for type, method and level. IGC used an old amendment of the QPL and since HS used the latest amendment of the QPL there is no correspondence between the reference and the products that were used. HS has chosen to use procedure TQ 1000 from IGC both for installed and separated splined sleeves. The procedure indicates the method (A washable in water), sensitivity (level III) and developer (Form a, powder). The following chemicals were used during the demonstration (corresponding to level E3):

- | | |
|-------------------------|------------------------------|
| • cleaning agent | White spirit |
| • fluorescent penetrant | ZL 66A produced by Magnaflux |
| • penetrant remover | S - 76 |
| • developer | ZP - 9E. |

The O-ring was not removed during the inspection. The actual inspection was undertaken using Black Light. The NDT technician who carried out the work, also carried out the NDT inspection on LN-OPG in Brønnøysund on 22 August 1997. He was able to confirm that the same method was used then. After the mandatory inspections were concluded, the engine was hoisted back and pushed into place. The AAIB/N was then informed that it was possible to damage the splined sleeve if it met the splined flange in a detrimental manner when the engine was being pushed back into place.

Representatives from the company have explained that Magnetic Particle Inspection (MPI) has been utilised with good results during inspections of separate splined sleeves. However MPI is not suited on the non-magnetic 100 µm thick hardmetal coating on the cylindrical part of the splined sleeve. A magnetic material is a condition for MPI.

1.18.2 Definition of a cycle

To be able to understand the time perspective in crack development on the splined sleeve and the splined flange, the cause of lines (beach marks) in the crack surface on components must be clarified. On the assumption that this pattern of lines is produced as a result of operational load during flight (cycles), it is possible to define a cycle in two different ways. These two options are given below.

1.18.2.1 *One take-off is a cycle*

The examination at DNV was based on a theory that high power output from the engines (high torque), which is used during take-off and landing, would be just the type

of significant event that would deposit lines in the crack surface (a cycle). The number of cycles would then coincide with the number of take-offs (landings). This is supported by the information given in MET 05.99.00.P8 paragraph 2.2 (Airworthiness Limitations):

"One cycle is equal to:

- one landing whether or not the rotor is stopped
- one external load transport operation".

The aircraft log for LN-OPG shows that the helicopter undertook 105 departures (the number of lines found on the splined flange) between 31 August and the date of the accident. Further, the helicopter log shows that as at 31 August 1997 it had flown 7 734 hours (62 flying hours prior to the accident).

1.18.2.2 *One start-up of the rotor is one cycle*

In connection with the accident, Eurocopter has written in a comment:

"it has been demonstrated through numerous fracture laboratory analyses that stop lines visible on a fracture are the result of full stress release of the load during a significant period of time."

This means that the number of cycles must coincide with the number of rotor start-ups. Since helicopters do not normally stop the rotor when waiting on helidecks in the North Sea, this means that the number of cycles for a given period will be considerably reduced. The log for LN-OPG shows that the helicopter undertook 105 start-ups (the number of lines found on the splined flange) between 12 August 1997 and the date of the accident. A DMR shows that, on 12 August 1997, the helicopter had flown 7 592 hours (204 flying hours prior to the accident).

1.18.3 Plasma spraying

1.18.3.1 *In general*

In the 1950's, materials that could withstand high temperature, act as a thermal barrier and are resistant against corrosion and erosion were asked for. Different types of oxides and carbides were suited, and plasma spraying was developed to apply them. The method is now well established and certified for a variety of applications in the industry. There exists several variations of plasma spraying, but the following general description can be given:

The material that shall be applied is in powder-form and it gets heated when it is fed into an arc. The arc is created in an ionised atmosphere between a tungsten cathode and a copper anode. Gas utilised is normally a mixture of Helium and Argon or Hydrogen and Argon dependent on level of protection and temperature that is specified. The particles (powder) accelerates to a speed of 300 to 600 m/s. The arc temperature is normally 15 000 °C. The particle temperature varies between 1 300 and 3 000 °C and

they pass the arc in a short period of time, typically 1 ms. The particles are then carried by the gas to the component which is to be coated. The cold component cools the particles at a very high rate (can be 10^6 °C/s). In this process it is important that the particles are shielded against oxygen by for example use of inert gas.

1.18.3.2 *Plasma spraying of tungsten carbides*

Tungsten carbides with cobalt matrix are applied at components to improve wear resistance. Tungsten carbide powder is produced by different means (sintering and crushing / agglomeration and sintering) and is delivered in different grain sizes. The stricter the size of distribution, the better will the result be.

Before application, the component must be cleaned and the surface given the desired roughness. This roughness is paramount to get a good mechanical bonding between the component and the coating. Several methods like blasting with aluminium oxides, steel grit or shot peening can be utilised followed by cleaning in order to prevent the blast medium from being left on the surface.

The application parameters are paramount for the final result. The window of opportunity for optimum results is small and rely on amongst others of gas mixture, gas flow, electrical current, carrier gas, protective gas, spraying distance, spraying speed, nozzles, powder quality, surface preparation, temperature and humidity in the spraying cabinet. These central parameters influence density, bounding (cohesive and adhesive) and wear resistance of the coating. Plasma spraying with tungsten carbides gives tensile stress. The coating is applied during several passes, and due to crimping, cracks can emerge as a result of this. Such cracks indicate too high temperature. The amount of undamaged carbides and the degree of oxidation are most decisive for the wear resistance. Porosity is of less importance.

Plasma spraying of tungsten carbides creates stress in tension and thereby does not improve the fatigue life of the component base material. Cracks in electrolytically applied chromium have shown to grow into the base material, and thereby initiate fatigue cracks. DNV has had projects where the same mechanism has existed for plasma sprayed tungsten carbides. It has not been found that this mechanism has contributed to crack growth in this case. However, when talking of spraying, it is clear that surface preparation by shot peening in general gives an improved fatigue life.

1.19 **Useful or effective investigation techniques**

1.19.1 Analysis of vibration data from HUMS collected at HS

1.19.1.1 *Introduction*

Against the background of the accident involving LN-OPG, HS implemented a major examination of IHUMS information from main gearboxes from 9 of the company's AS 332LI helicopters. Recorded vibration data was handed over to GKN Westland Helicopters (GWHL) for analysis. It was decided that the examination should concentrate on vibrations from the "Left Hand and Right Hand High Speed Input and

Torque Shafts". In addition to vibration data, information about helicopter bases and maintenance was also handed over. The data was first statistically examined to sort out instrument failures and other obvious deviations. The data was then examined to find statistically abnormal parameters or significant development characteristics in the parameters. If these findings could not be given a natural explanation, they were examined further. GWHL used its own software to carry out this work. The result of the examination is reproduced in the GKN Westland Helicopter report "Research Paper RP 1035". For supplementary information, please see figs. 5 and 7.

1.19.1.2 Examination results

The principal results from the examination are reproduced using measurement unit g. The most relevant measurement parameters are:

SIG_PP	Peak to Peak of signal average
SIG_SD	Standard Deviation of the signal average

The examination showed that information from LN-OPG was typical right up to the change of main gearbox in spring 1997 (installation of MGB no. M170). At this time, the vibration pattern changed considerably (see fig. 63). To examine this phenomenon further, 5 data recordings from DAPU channel 6 (Right Torque Shaft - Aft End) were made before the gearbox change in comparison to 33 equivalent data recordings made after the replacement. This may be illustrated by comparing the three recordings made during a flight prior to the replacement (see fig. 64) with three recordings made during a flight on 18 June 1997 (see fig 65). Fig. 65 also shows that the pattern of vibrations changed considerably between the three recordings made during the same flight, a phenomenon that was not recorded on other gearboxes. Fig. 66 shows the frequency spectrum from DAPU channel 6, plotted along one axis. The plots originate from LN-OPG from before the MGB replacement and, according to GWHL, represent a spectrum that would be expected normally. Dominant frequencies are affected by the number of teeth on the wheel that drives the R/H Accessory Gear Box (27), the gear in the rear edge of the torque shaft (35) and twice this same frequency (70). These figures can also be expressed as the 70th harmonic of the rotation speed (8 000 RPM), for example. Fig. 67 shows three recordings made during a flight on 1 August 1997 (MGB no. M170). The considerable variation between the three recordings comes out quite clearly. In addition, the frequency pattern is quite different to that shown in fig. 66. The frequency caused by the gear at the front end of the torque shaft (89) emerges quite clearly and is dominant in the last two recordings. In addition, the spectrum contains frequencies which are 32, 34, 66, 68 and 74 times higher than the base frequency caused by shaft rotation. According to GWHL, these frequencies cannot be explained on the basis of rotation speeds on shafts or traced back to the number of teeth on the gear in the gearbox. The changes that took place on one and the same flight were verified by comparing information recorded at the same time on several channels. GWHL has discussed the results of the comparisons as follows:

"As the change is apparent at several gearbox locations it could be suggested that the whole gear train is vibrating differently for certain periods. It could

also be suggested that the vibration from one location is being transmitted around the gearbox and being sensed at many locations."

1.19.1.3 *Assessments carried out by GKN Westland Helicopters*

The following quotation is taken from the report:

"Variability in the vibration signals is not unique to this type of transmission and is common on many aircraft types. However it is unusual to have frequency components dominating the vibration signals which are not obviously associated with the gears and shafts in the transmission."

and

"There is evidence that so called "ghost" frequencies introduced during the manufacturing process can be found in the vibration signals but this would not explain why the components should come and go unless they were particularly sensitive to operating condition."

and

"This said even if there was some form of complex vibration behaviour present then the potential consequences on the gearbox components may be benign and non-damaging. However in some circumstances it could cause wear or some form of component distress. Whether any damage occurs is dependent on whether the vibration behaviour causes relative motion between components and thus damage such as fretting or causes overloading of the components to cause fatigue damage."

1.19.1.4 *Conclusions from GKN Westland Helicopters*

The following quotations are taken from the report conclusions:

"Although unusual characteristics have been identified on the last gearbox on LN-OPG when compared to other gearboxes on LN-OPG it has not been possible to categorically identify the source of the variability. Similarly as other main rotor gearboxes with 'odd' vibration frequencies have been found these phenomenon may be 'normal' characteristics of the Super Puma main rotor gearbox and may be non-damaging. However to explore this further and to draw general conclusions it is likely that extensive further work which should involve the aircraft design authority will be required."

and

"The potential for this vibration behaviour to cause component distress should be discussed with the design authority and only be confirmed after discussion with the design authority."

1.19.2 Examinations of vibration patterns on main gearbox (MGB) M665 at HS

1.19.2.1 *Introduction*

The examination of the R/H input pinion and 8 000 RPM wheel from LN-OPG at ECF (see subparagraphs 1.16.5.6, 1.16.7.2 and 1.16.7.3) led to the possibility of questioning the extent to which wear on the components could have been a contributory factor in the accident. This possibility was further realised by the information that emerged in connection with the examination of the MGB with serial no. M136 (see subparagraph 1.6.7.2) and the analysis of the HUMS data carried out by GKN Westland Helicopters (see subparagraph 1.19.1). On the basis of this, the AAIB/N decided to participate in an examination to clarify, if possible, the way in which the R/H input pinion and the 8 000 RPM wheel from LN-OPG affected the vibration pattern in a randomly selected gearbox. A gearbox, serial no. M665, which was to be sent to HS for a complete overhaul, was chosen for the examination which took place on the test bench at HS in May 2000. To allow comparison, the R/H 8 000 RPM wheel from gearbox M136 was also tested. The following equipment was used during the test:

- Brüel & Kjær Tape Recorder type 7007
- Brüel & Kjær Accelerometers type 4391
- Brüel & Kjær Calibration Exciter type 4294
- Brüel & Kjær Multianalyzersystem PULSE type 3560 (dual channel FFT analyser).

During the majority of the examination, the gearbox was equipped with an accelerometer near each of the gearbox shaft inputs. During the course of the examination, the gearbox was rebuilt several times but, principally, two passes were performed for each gearbox configuration.

These two were as follows:

- Stable speed equivalent to 100% Nf and stable torque of 64% (2 x 300 Nm)
- Acceleration of speed from 0 - 23 000 revolutions per minute (Nf), a short period at a stable speed and then a reduction to 0. A torque increasing to 2 x 150 Nm reached at 5 000 revolutions per minute, and then stable. (The acceleration was 50 revolutions per minute per second).

The information on speed of rotation was taken from a sensor mounted on the tail rotor output shaft. The speed was then converted in such a way that the examination results referred to the speed of the 8 000 RPM wheel/torquemeter shaft. The gearbox was

driven by two shafts which are rather different in design to the Bendix shaft used in helicopters, but a standard splined flange was used.

1.19.2.2 *Examination results*

Test 1

MGB no. M665 was installed on the test bench and run just as it was on receipt at HS. Analyses of the signals showed that the vibration pattern was as expected both in shape and level. In addition, there were insignificant variations between the signals from the R/H and L/H sides. The results from the R/H accelerometer are displayed in fig. 68.

Test 2

The O-rings on the splined sleeve (MS9388-133) were then removed and the gearbox was run once more. The results from the R/H accelerometer are displayed in fig. 69 (the visible horizontal lines are faults in the recordings). By comparing figs. 68 and 69, it is not possible to detect any significant differences.

Test 3

The R/H input pinion/8 000 RPM wheel from LN-OPG was installed on the R/H side of the gearbox. The parts were assembled with used, but undamaged bearings which had been disassembled during a previous gearbox overhaul. The O-rings were put back on the splined sleeve. The results from the R/H accelerometer are shown in fig. 70. In comparison with figs. 68 and 69, the vibration pattern has changed considerably. The prominent feature is a series of peaks between 30 and 40 shaft order (seen in relation to the speed of the 8 000 RPM wheel). In addition, the signal level has increased considerably from peaks at approx. 4 g during test 1 to 122 g at 33 shaft order. The vibration pattern for the L/H accelerometer also reflects something of this increase with a peak of approx. 40 g at 33 shaft order. A "run up" from 600 - 8 000 RPM is shown in fig. 71. Vertical lines represent areas in which vibrations lead to natural oscillations (resonance frequencies).

Test 4

Once more, the O-rings were removed from the splined sleeve on both sides. The vibration pattern changed corresponding with what had been observed in tests 1 and 2.

Test 5

The O-rings were re-assembled on the splined sleeve (repetition of test 3). The results corresponded with the results from test 3. A series of step-by-step, slow acceleration tests were carried out in this configuration.

Test 6

Components from LN-OPG were moved over to the L/H side of the gearbox. The original components from M665 were re-assembled on the R/H side. O-rings were fitted on both splined sleeves. In this configuration, the installation of accelerometers at various places and on several axes was tried out. Analyses of the signals showed that the vibration pattern that was characteristic of LN-OPG had moved over to the L/H side of the gearbox.

Test 8

The gearbox was put back to its original condition, but the R/H 8 000 RPM wheel (serial no. M 624) from gearbox no. M136 (see subparagraph 1.6.7.2) was re-assembled on the L/H side. O-rings were fitted. Fig. 72 shows that the vibration pattern that arose coincides, to a great extent, with what is shown in fig. 70.

Test 9

The gearbox was put back to its original state and the similarity in the vibration pattern, in comparison with test 1, confirmed the fact that the tests could be repeated with commensurate results.

In addition to recording vibrations from the MGB while running, relatively simple hammer tests were carried out on the MGB and components in order to chart the components' resonance frequencies (natural oscillations). This indicated that large parts of the gearbox were damping and "dead" within the range 3 000 Hz - 13 000 Hz. Similarly, the resonance frequencies of the 8 000 RPM wheel and the input pinion were outside the current frequency range. The hammer tests on the torquemeter shaft and the Bendix shaft do not exclude the fact that the resonance frequency on these components could hit vibration frequencies that might arise in the input pinion / 8 000 RPM wheel combination. However, great uncertainty is linked to the hammer tests as, amongst other things, they were not carried out with components suspended in the gearbox while subject to loading.

2 ANALYSIS

2.1 Introduction to the analysis

The AAIB/N has chosen to divide the analysis into 10 main parts:

2.2 A description of the actual accident, as the AAIB/N believes that it took place, on the basis of available information.

2.3 Analyses of 14 barriers that might have prevented the accident if they had been present or functioning as intended.

2.4 An analysis of possible causes of the fault that arose in the splined sleeve.

2.5 An analysis of a possible period of fault development in the splined sleeve.

2.6 A summary of the analysis of the technical conditions in 2.2 - 2.5.

2.7 An analysis of control documents – the documented quality system, procedures and the people in the process.

2.8 An analysis of the NCAA inspection.

2.9 An analysis of maintenance carried out in the company.

2.10 An analysis of HUMS.

2.11 - 2.14 Analyses of other conditions relevant to the accident.

2.2 Analysis of the course of events during the flight on 8 September 1997

2.2.1 The examination work carried out in conjunction with the accident involving LN-OPG has shown that, on the morning of 8 September, the helicopter had a mechanical fault in the drive train between the R/H engine and the main gearbox. This fault had developed and become worse over a period of time. During the last flight, it was not any unusual situation that provoked the accident. When the PFC was performed that morning, it was not possible, using the inspection method described, to record anything seriously wrong with the helicopter.

2.2.2 The AAIB/N has received no information to indicate that anything abnormal was recorded during the first part of the flight. On the contrary, information obtained from the air traffic control service and the CVR indicates that the flight was quite routine. The AAIB/N believes that both the R/H splined sleeve and the R/H splined flange was cracked to a considerable extent prior to commencement of the flight. It is not possible to state the time at which the lock washer came loose and began to move, but such

movement is due to the fact that the splined sleeve, and possibly also the splined flange, had "opened up". The marks left on the lock washer (see fig. 28) show that this had become tilted in stages and that it had consequently been happening over a period of time. A gradual cracking of the splined sleeve and the splined flange, and the subsequent gradual loosening of the lock washer, caused increasing vibrations in the engine, the Bendix shaft and the MGB. In the opinion of the AAIB/N, these vibrations were recorded by the CVR 7 mins. prior to the accident. Around half a minute later, the crew observed an indication light down on Sub-panel 34, but the light came on for such a short time that the two pilots were not fully in agreement about what they had seen. The pilot-in-command seemed certain, however, that he had seen the OVSP light for the R/H engine. This observation may be explained by the fact that the Bendix shaft was vibrating so much at the time that it affected the engine and the liaison tube in such a way that, for a moment, the phonic wheel may have come into contact with the speed sensors and, in the next moment, the distance might have been too great. According to Turbomeca, this can lead to the system recording an RPM lower than the shaft's speed of rotation. This can also be supported by FDR information that shows an irregular reduction of Nf 2 values (see fig. 11). If an RPM (Nf) of less than 25% is recorded, the OVSP light comes on, but it goes out as soon as the RPM rises above 25% again.

- 2.2.3 At T - 5:11 min., the co-pilot spoke in a manner suggesting that he had seen two lights. The system for RPM regulation works on the same principle as the RPM limitation (overspeed). Consequently, the same types of vibration can affect it. The "GOV" will light up on loss of signal from one of three signal transmitters. In the opinion of the AAIB/N, all of the observations made by the crew at this time may be explained by weaknesses in the system for RPM recording.
- 2.2.4 The expressions from the crew indicated that this was an unusual fault indication. The conversation that was recorded on the CVR indicates that they picked up and read from the Emergency Checklist without finding anything that suited their situation. The thought that immediately suggests itself is that the crew settled down again at the time, believing that this was a problem with the indicating system. The AAIB/N considers this to have been a natural reaction, on the basis that the rest of the instrumentation most probably showed normal values and that false alarms from the engine's RPM system had occurred previously. The OVSP and the GOV lights were not located on the central Failure Warning panel. In the opinion of the Board, this would instinctively contribute to reducing the degree of seriousness of the indication.
- 2.2.5 The conversation that was recorded on the CVR indicates that the crew was receiving more abnormal indications around one minute before the accident. These may have been abnormal variations in the indicated Nf 2, possibly combined with the OVSP and/or the GOV lights. Failure of a sensor was mentioned as one possible explanation and the last 30 seconds prior to the shaft fracture were probably used for analysing the situation.
- 2.2.6 With great probability, the lock washer and circlip then came loose from the splined sleeve and went into the Bendix shaft. ECF has calculated that the lock washer affected the shaft wall of the Bendix shaft with a static force of around one tonne. This sudden

event may have led to the harmonic overtones from the Bendix shaft disappearing around 1.6 secs. prior to T (see fig. 12). The loading from the lock washer led to the shaft losing balance completely and to the shaft wall being torn after a short time due to static overload. This was recorded by the CVR as a thud in the helicopter (T). Because of the torque transmitted by the shaft, it tore in a spiral pattern. At the same time, the shaft split close to the MGB and the spiral end of the Bendix shaft continued to rotate, powered by the R/H engine. The AAIB/N believes that the spiral spread and increased in diameter so that rotation marks were left inside the liaison tube and on the front of the bellows in the MGB end of the Bendix shaft. As a result of this, fragments of the Bendix shaft were torn off and the lock washer and circlip sustained damage. The section of the Bendix shaft (the spiral) that continued to be powered by the power turbine had completely lost equilibrium and transmitted a torque, caused by the "braking effect" due to contact with the inner wall of the liaison tube and the MGB end of the Bendix shaft. These loadings led to the shaft also being split at the bellows at the "engine end". In the first second after the first shaft fracture, the AAIB/N believes it can be established that the engine's EECU recorded an increase in the Nf 2. A reaction to this would be for the EECU to reduce the supply of fuel to the engine with a consequent reduction of Ng 2. This can be confirmed by the fact that the FDR recorded a drop in Ng 2 for a short period. The AAIB/N believes that the R/H EECU then lost Nf information. The system for speed control and overspeed protection was then disabled. The built-in logic then caused the EECU to increase its fuel supply to the engine to achieve 104% Ng. The power turbine, which had no loading at all, then increased its RPM to approx. 175% Nf. At this speed, it was torn to pieces by centrifugal forces and fragments were ejected with great force from the rotation plane of the power turbine.

2.2.7 The explosive incident at both stages of the power turbine in the R/H engine cut the engine into two parts and caused major damage to the helicopter in the turbine's plane of rotation. As a result, the engine housing, the fireproof bulkhead between the engines and the cabin roof were cut through. Fragments that went through the cabin roof cut two of the control rods to the main rotor and the control rod to the tail rotor. The L/H engine was hit with the result that this power turbine also lost equilibrium and parted from the engine, principally as one unit, upward and a little to the right (viewed from behind). This sequence, from the time at which the R/H engine burst until the power turbine on the L/H engine disappeared, happened during the period from T + 1.7 secs. to T + 2.3 secs. This was recorded by the CVR as an intense sound. The AAIB/N has found nothing to indicate that any passengers were injured by fragments from the engines, which penetrated the passenger compartment.

2.2.8 After this, the helicopter was uncontrollable and without engine power. On the basis of the information available, the AAIB/N believes that the helicopter immediately went out of control. It has not been possible to state anything with certainty regarding the helicopter's fall towards the sea, since there is very limited information available about this phase. Two factors recorded by the FDR during this period need an explanation, however. The first is that the speed of rotation of the main rotor during the period from T + 9 secs. and up to the point at which the recording broke off, increased from 26% to 95%. The recording is supported by the fact that the gearbox oil pressure increased

correspondingly. The AAIB/N believes that the only explanation for this is that the main rotor autorotated for a period of time. The second factor is that the helicopter appears to have lost only 40 ft of altitude during the course of the first 11.6 seconds after going out of control. This recording cannot be supported by any other information, and the possibility of damage to or failure of the helicopter's altimeter system or an erroneous recording in the FDR cannot be excluded. If the recording is correct, this can only be explained by the fact that the helicopter's kinetic energy, perhaps in combination with the main rotor's kinetic energy, was converted to lift via the main rotor during this period.

- 2.2.9 In the opinion of the AAIB/N, examinations of parts of the wreckage show that the main rotor plus gearbox, Bendix shafts, liaison tubes, exhaust pipes, miscellaneous cowlings and parts of the engine's module no. 5 were torn up and back, and parted from the helicopter before it reached the surface of the sea. This conclusion is based on the general pattern of damage and on the fact that the main gearbox front suspension bar had no fire damage above the site of the fracture. The fire damage at the lowest part of the suspension bar can be explained by the fact that, after the fracture, this part remained in place behind the L/H gas generator section which continued to operate, and which therefore subjected the area at the back to heat damage. Details from the FDR and the pattern of damage on the gas generator section support the theory that this rotated at high speed right until the helicopter hit the surface of the sea.
- 2.2.10 Two of the main rotor blades came loose from the rotorhead in an apparently inexplicable manner. However, on consideration, it is clear that this was secondary damage and not a causal factor for the accident. ECF has provided information that two similar blade separations have occurred previously, in conjunction with impacts with the ground during accidents. This was explained by the fact that the rotor blades were subject to a shock load at the same time as centrifugal forces. This theory must mean that the shock load opened the blade sleeve sufficiently for the blade to be able to separate without significant damage to the threads. Then, the blade sleeve returned to a shape that was very close to that specified. Based on this, there is reason to assume that the rotor was operating at a considerable speed when the blades came loose and that the shock load occurred when the MGB and the rotor were torn off the helicopter, or when the main rotor hit the surface of the sea.
- 2.2.11 In the opinion of the AAIB/N, the helicopter fell almost vertically after breaking up in the air. The impact with the surface of the sea caused such great damage to the helicopter that it sank after a very short time. This may explain why all of the parts were found within a relatively limited area on the seabed.

2.3 Causal factors significant to the course of events

2.3.1 Introduction

The cracking in the power transmission between the R/H engine and the gearbox in LN-OPG has much in common with the examples mentioned in chapter 1.6.7.2. However, what differentiates this accident from all the other occurrences is that the lock

washer came loose and entered the Bendix shaft. Seen in isolation, the direct causal factor for the accident can therefore be linked to the lock washer. However, the lock washer came loose as a direct consequence of the splined sleeve, and then the splined flange, starting to crack. For this reason, the AAIB/N has spent significant resources in an attempt to map the reason why the splined sleeve started to crack. In addition to focusing on the splined sleeve, the AAIB/N has, during this accident investigation, uncovered a long series of complex and compound factors that have been absolutely crucial to the outcome of the accident. The accident could have been prevented if just one of these factors had been dealt with in some other way. A metaphor for this would be the domino effect, with each of these conditions being represented by one domino. The AAIB/N believes that the list below contains a chronological overview of the individual factors which, with great probability, resulted in the accident, or represent safety barriers which do not seem to have worked as intended:

- a) the design of the shaft between the engine and the MGB
- b) no certification requirement for totally independent systems for RPM regulation and overspeed protection
- c) the relevant failure in the systems for RPM regulation and overspeed protection was not discovered and dealt with on the basis of risk analyses of the engine or engine installation
- d) a total maintenance solution that, as a whole, contained several weaknesses
- e) for several days prior to the accident, the HUMS information system recorded and stored details showing that something abnormal was about to happen in the shaft coupling between the R/H engine and the main gearbox, unknown to anyone
- f) the HUMS accelerometer containing the "alarm function" that monitored the problem area was out of service
- g) the crew was not trained to understand the degree of seriousness of an OVSP light that comes on at irregular intervals
- h) the lock washer and circlip on the R/H side came loose and got into the Bendix shaft
- i) the R/H Bendix shaft did not break at the intended locations (the bellows), the Fail Safe Bearings had no function and this led to strong vibrations
- j) the vibrations in the Bendix shaft led to the EECU for the R/H engine losing the signals for speed regulation of the power turbine (Nf)
- k) the EECU, as a consequence of design, increases the fuel supply corresponding to 104% Ng in the event of loss of Nf information
- l) the system for overspeed protection on the R/H engine was put out of service
- m) the engine's turbines were not equipped with protection that could withstand a "turbine explosion"
- n) vital controls went close to the engines and three of these were cut by splinters from the R/H engine.

These conditions are analysed in more detail in subparagraphs 2.3.2 - 2.3.15.

2.3.2 Design of the drive train between the engine and the main gearbox (MGB)

2.3.2.1 The AAIB/N has not examined the helicopter manufacturer's choice of solutions for power transmission between the engine and the MGB. According to information supplied by ECF, however, they had been faced with two principal solutions. The first was to gear down the power turbine's high speed of rotation in direct connection with the engine, thereby obtaining a lower speed of rotation on the shaft. However, this led to an increase in the torque that was transmitted and therefore to a need to increase the dimensions of the drive shaft. In the solution that was chosen on the AS 332, all down-gearing takes place in the MGB, but the shaft becomes more vulnerable to imbalance and vibrations due to the high speed of rotation used. It is unfortunate, in this connection, that the Bendix shaft is open at both ends, making it possible for foreign objects or pollutants to enter the axle. Both the occurrence in the US (see subparagraph 1.6.7.2), and this accident have proved that the lock washer can loosen. For LN-OPG, this led to failure of the Bendix shaft, the system for regulation of the motor's RPM and the overspeed protection system. Such a solution has, as in this case, proved to lead to a fatal accident.

2.3.2.2 A review of the available information shows that the solution that was chosen on the AS 332 created a series of problems over a long period. However, representatives from ECF have provided information that reporting of incidents involving the drive train ceased in 1988, and that this was due to a number of improvements that were implemented in that period. The accident involving LN-OPG, the incident with the helicopter in the Swedish Army, the reported case of a loose lock washer in the USA and the cracking of the splined sleeve in Japan have shown that the problems with the design have not been finally resolved.

2.3.3 Certification requirements for systems for RPM regulation and overspeed protection

2.3.3.1 As far as the AAIB/N has learnt, at the time the AS 332L1 was certified, no specific certification requirements were set for either RPM regulation or overspeed protection for the engine. The certification requirements for the engine installation, and the engine itself, use the expression "reasonable assurance that those engine operating limitations that..... will not be exceeded in service" (see subparagraph 1.6.5.2 and 1.6.5.3). The AAIB/N believes that this formulation provides major opportunities for the use of discretion. The accident has shown that turbine RPMs of the order of 180% have to be prevented. It has also shown that the RPM was not limited below this critical level because the systems for RPM regulation and overspeed protection were not totally independent (redundant) but, on the contrary, had a joint mechanism that failed (the method for RPM recording). The AAIB/N believes that if protection against overspeed cannot be assured in some other way, certification requirements should be specified for two completely independent systems for controlling and limiting the speed of rotation on free turbines in helicopters.

2.3.4 Risk analysis (safety analysis) of the engine and engine installation

- 2.3.4.1** As discussed in the subparagraph above, the certification requirements were not very specific and were, to a large extent, open to interpretation. Thus, according to ECF, compliance with the requirements in FAR 29.903 (f) was established by the statement that: "The engine is stopped automatically if the free turbine rpm exceed 120%". This wording was approved by the DGAC, and it appears that the requirements for engine installation were fulfilled on this basis in 1985.
- 2.3.4.2** However, the AAIB/N would like to point out some adverse factors in the solution that was used. The systems for RPM regulation and overspeed protection on the Makila engines use the same method (a pickup that records flux variations) for RPM recording. RPM recordings for both of the systems are carried out at the same place (behind the power turbine) and vibrations in the shaft or turbine actuate both systems. The risk of undesired vibrations occurring in this area must already have been known at the time the helicopter was designed. This is evidenced by the fact that the Bendix shaft has been given two weak sections (in the bellows) that are intended to fail on overload, plus Fail Safe Bearings that are intended to limit the vibrations in such situations. The weakness in the system for RPM recording was demonstrated in January 1984 with LN-OMF when bearing no. 5 in the engine broke up, and in October 1985 with LN-OMG when the splined sleeve failed (see subparagraphs 1.6.9.2 and 1.6.7.2). After the accident involving LN-OPG, the weakness was demonstrated afresh in the Swedish Army in 1998 and in Japan in 1999. The degree of seriousness of this weakness was reinforced once more by the fact that the EECU increases the fuel supply to the engine in order that this should reach 104% Ng if the necessary Nf information is missing. These cases show that there is a real risk of failure in the system for RPM recording, and that, in combination with a fracture in the Bendix shaft, this can lead to overspeed.
- 2.3.4.3** There is reason to believe that the consequences of the loss of RPM control on the power turbine were known when the AS 332L1 was being developed. According to information supplied by Turbomeca, the power turbine has a critical speed of rotation of 180%. A speed of rotation close to this implies a risk of destruction for the engine and the helicopter and is a direct threat to those onboard. A potential failure of the engine's regulation system and overspeed protection must therefore be considered a critical situation and the systems must be assessed as critical. It has been a principle in the design of critical systems in aircraft to create double or triple systems. In such cases, endeavours have been made to ensure that parallel systems work on different principles, and that they are as different as possible with regard to components and location. This principle does not seem to have been adhered to in the design of this engine. There is an interface where the respective areas of responsibility of ECF and Turbomeca meet, and the AAIB/N considers this to be where a holistic risk analysis of the conditions discussed should be based. There is reason to believe that this may have had an effect on the decisions that were taken.
- 2.3.4.4** The AAIB/N has no detailed knowledge of the risk analyses and assessments that formed a foundation for developing the helicopter, the engine and the subsequent certification.

However, there is reason to look back at the analyses that were undertaken in relation to the requirement in FAR 33.75 applicable to the engine:

"It must be shown by analysis that any probable malfunction or any probable single or multiple failure, or any probable improper operation of the engine will not cause engine to-

(a) ----

(b) Burst (penetrate its case)"

The accident has shown that a single failure, in this case the lock washer loosening and entering the Bendix shaft, caused the axle to fail (forming the basis for a possible overspeed) and took out both of the systems that can limit the engine's RPM. There is good reason to question why this serious possibility was not found and corrected during the construction and operational phases of this helicopter model. With knowledge of the relevant course of events leading to the accident, it appears evident that modern principles for risk analysis ought to have detected weaknesses in the systems for RPM regulation and RPM limitation, had they been used.

2.3.5 Maintenance

The AAIB/N has detected several weaknesses in the overall maintenance concept used on LN-OPG. These include the following:

- the splined sleeve and splined flange were maintained in accordance with the "on condition" (OC) maintenance procedure, and were consequently not maintained based on flight time. Furthermore, they did not have serial numbers. Overall, this contributed to it being difficult for ECF and HS to have any overview of the working life of the parts, and to little attention being given the parts
- new splined sleeves were not subject to a final check at ECF prior to being installed on the MGB
- the maintenance instructions, MET 63.10.00.602, do not require any inspection for wear or any other damage of the splines, either on the splined sleeve or the splined flange. Particularly in consideration of the hardmetal coating on the spline sleeve being only 25 µm thick, the absence of such an inspection requirement must be regarded as a weakness
- the prescribed NDT-method demands a high skill-level of the NDT-operator. The investigation has revealed that it can be difficult to discover small cracks on the hardmetal coating on the splined sleeve. This is discussed in subparagraph 2.9.3.
- deficiencies in the maintenance instructions meant that the following inspections were not carried out, or it can not be documented that they were carried out in connection with inspection of the coupling between the Bendix shaft and the MGB on 22 August 1997 (see appendix A):

- 3.1 Verification of tie rod
- 3.2 Visual check for fretting on diameter "B"
- 3.4.2 Check of the clearance
- 3.4.2.2 Installation of the seal
- 4.1 Inspection of the splined flange and check for wear on bore "C"
- 5 Sleeve concentricity check

- Even if MET 71.00.00.401, subparagraph 5 contains a general requirement for "check cleanliness" for the splined flange, the status of the splined flange was not verified. Consequently, abnormal wear on the splines on the splined flange cannot be excluded. Such possible high levels of wear are a factor which, according to ECF, could have contributed to the splined sleeve being subject to loadings producing fatigue
- O-ring (MS9388-133) was missing on the R/H input pinion when the Bendix shaft was replaced on 16 July 1997. It is probable that this had been missing since the last G-check. Experiments have shown that the O-ring has a damping effect on movements between the splined sleeve and the splined flange. The AAIB/N therefore believes that this deficiency may have hastened the process of degradation in the coupling.

The causal factors which might have had a direct influence on the cracking of the splined sleeve cannot be ascertained with any certainty. Consequently, it is not possible to link any individual factor directly to the course of events. However, the AAIB/N believes that the aforementioned weaknesses during maintenance may together constitute such a significant factor that they cannot be ignored as being contributory to the accident.

Some of these points will also be discussed in more detail in subparagraph 2.9.

2.3.6 IHUMS recorded a potential fault in the area several days prior to the accident

- 2.3.6.1 Both the accelerometer for the power turbine and the epicyclic bearing in the gearbox recorded and stored information concerning an increasing level of vibration in the area of the Bendix shaft for several days prior to the accident. The information about the increased vibration level in the power turbine was saved in a database and was available, but not known, at the time of the accident. In the opinion of the AAIB/N, the marked increase in vibration level recorded between 2 and 3 September (see fig. 60) would probably have led to some reaction if it had been known. The most central accelerometer (R/H input pinion) was out of service. The paradoxical thing about the situation is therefore that IHUMS recorded this marked development before the accident despite the most central accelerometer being out of service, but the

information it recorded was to no avail. This marked development could have been disclosed if all data had been manually analysed. However, the AAIB/N understands that HUMS gathers a lot of information from the company's helicopters in total and that system does not intend for this data to be analysed manually.

2.3.6.2 The AAIB/N believes that the graph showing the level of vibration between 2 and 3 September climbs so markedly that a developed system for automatic trend monitoring would have been able to discover that there was something wrong in this area. HUMS, as installed in LN-OPG, had no trend monitoring. In addition, no limit values had been set for the vibration level on the power turbine. This shows that there was significant potential for development in the system that was not being utilised. The AAIB/N believes that the data acquired from the power turbine would most probably have led to inspections being carried out before the accident, if the following conditions had been in place:

- A fully developed system with limit values on all accelerometers
- Trend monitoring of the relevant vibration data
- A daily review of all HUMS Log Reports and monitoring of breaches of all set limit values.

The AAIB/N therefore believes that resources should be applied to develop further the processing and analysis of the signals in the system itself, particularly with regard to trend monitoring and the setting of limit values.

2.3.7 IHUMS accelerometer out of service

2.3.7.1 The accelerometer near the R/H shaft input on the MGB was out of service and had been so for a period of more than two months prior to the accident. This accelerometer had a limit value set at 4 g. The accelerometer that was located at the engine end, and therefore further from the source of vibration, recorded values of approx. 7 g. Even if direct conclusions should only be drawn with caution, the AAIB/N finds reason to believe that the accelerometer at the input pinion might have recorded and warned of the relevant fault development in time, allowing the accident to be avoided. However, in general, the AAIB/N would like to stress that HUMS is a system which does not give absolute answers and that good background knowledge and experience are necessary for interpreting information from the system. With hindsight it appears that, despite the company stating that they had invested major resources in HUMS, no procedures had been drawn up for correcting faults in accelerometers, for example. HUMS is discussed further in subparagraph 2.10.

2.3.8 The possible effect of the OVSP light on the course of events

2.3.8.1 The AAIB/N believes that, on the part of the manufacturer, the OVSP light was intended to have a purely informative function and consequently, if the light lit up, it was not intended to lead to any immediate reaction on the part of the crew. This is reflected in the way the light is discussed in manuals and training materials, and the fact that the light is not located on the Failure Warning panel. On a newer model, the

AS 332L2, the OVSP light has been moved up onto the instrument panel itself. This location is more central and gives the crew a better opportunity to detect the light.

- 2.3.8.2 The small, amber light is positioned directly above the GOV light (see fig. 4). The AAIB/N considers it natural that short flashes of light from this light may be difficult to locate exactly. Contributory to this is the fact that the light does not have a very central position and because it can be confused with the GOV light. This may be an explanation of why there was no clear agreement among the crew as to what had been observed. There is reason to assume that the crew knew that the OVSP and GOV lights had indicated false on previous occasions. The AAIB/N therefore considers it natural that a quick flash of the OVSP light did not lead to any immediate reaction. In addition, in a real overspeed situation, the OVSP light would start to flash at the same time as a series of other indications would have been appearing. This was not the case on this occasion. The AAIB/N therefore believes that the crew only became aware that they might have a problem one minute before the accident, and that they had not realised the degree of seriousness until the accident had actually occurred.
- 2.3.8.3 If the crew had been aware of the seriousness of the situation, the R/H engine could have been shut down and the accident avoided, right up until the Bendix shaft broke. For this to happen, the crew would have had to have had sufficient background knowledge and have been given unambiguous indications. The AAIB/N believes that a helicopter crew cannot be expected to have such a thorough understanding of regulating systems that they can read "between the lines" of information. In addition, the Approved Flight Manual, including checklists and training information from the helicopter manufacturer, did not give guidelines for the situation. The situation in question had not been foreseen and consequently the crew had not trained for it. On the basis of the information that emerged during playback of the CAR from LN-OPG, Turbomeca immediately ordered all operators of Makila engines (Fax Alert) to stop the engine concerned if the OVSP light came on while airborne. In the opinion of the AAIB/N, this order will considerably reduce the chances of a similar situation being able to arise. In addition, the objective ought to be to train on situations involving the OVSP and GOV lights so that these are understood and can be dealt with in a safe manner.
- 2.3.8.4 One of the prerequisites for the crew receiving the relevant training to tackle a situation, is that the helicopter manufacturer should be aware that the situation might arise and that the necessary information surrounding this is notified to the company. It is, to a certain extent, understandable that the malfunction in question was not foreseen during the development of the engine. This is greatly dependent on the extent to which the helicopter and engine manufacturers systematically analysed the faults that might arise in a system. However, the AAIB/N is critical of the fact that, as far as the AAIB/N is aware, the practical operational experience that has emerged (such as the occasions reported at HS in January 1984 and October 1985) did not lead to any changes in the engine's control and indication systems or procedures or information to the operators. To increase understanding of this system, the AAIB/N is of the opinion that ECF should inform all operators of the helicopter type in question, that both speed sensors must be in service if the engine is automatically to shut down on overspeed. The manufacturer should furthermore advise on the effects the vibrations in the

engines and Bendix shaft can have on the system that records the power turbine's speed of rotation. The AAIB/N also believes that ECF should assess whether the OVSP light should be moved to a more visible location and if it should be given a status other than a purely informational one.

2.3.9 Loose lock washer and circlip

ECF has calculated that the lock washer, if it comes loose and gets into the Bendix shaft at a normal RPM, would affect the shaft wall with a static force of around one tonne. This is assessed as being far more than the shaft wall would tolerate, so that it would immediately break. The circlip weighs much less, but would also contribute to loadings and vibrations if it came loose and got into the Bendix shaft. The AAIB/N is of the opinion that several of the reported incidents involving cracks in the splined sleeve could have ended up as an accident if the lock washer had come loose and got into the Bendix shaft (see fig. 6). It is therefore important to design the shaft coupling so that this cannot happen. One of the weaknesses in the design in question is that the lock washer can come loose if the splined sleeve cracks so that it opens at the front end. This becomes worse if the splined flange also cracks and thus provides space for the splined sleeve to open further. The method used for holding the lock washer on the AS 332L2 has been changed considerably in relation to the AS 332L1, so that the lock washer does not necessarily loosen even if the splined sleeve cracks (see fig. 9). The AAIB/N believes that the factory should evaluate whether such a design might increase flight safety if it is fitted retrospectively on the AS 332L1.

2.3.10 Fail safe bearings

ECF has stated that the bellows in the end of the Bendix shaft had two functions. The first was intended to pick up relative movement between the engine and the helicopter's main gearbox. The second function was to serve as a weak point that would fail before the shaft itself in the event of abnormal loadings (see subparagraph 1.6.3.4). The investigation has discovered that the shaft was exposed to an unforeseen loading, such that the shaft pipe broke before the bellows. This led to the centering function of the Fail Safe Bearings being unable to prevent a strong imbalance in the area. The AAIB/N believes that the design of the Fail Safe Bearings has justified itself in several cases of "controlled" fractures of the Bendix shaft. The Board believes, however, that it would be difficult to design them to deal with a situation in which the lock washer gets into the shaft. The manufacturer should therefore focus on preventing loose parts from getting into the shaft.

2.3.11 Loss of Nf signals to the EECU

2.3.11.1 Recordings from the FDR show that the Nf 2 signal to units such as the indicator in the cockpit varied at an early stage. This indicates that the system, even at relatively moderate vibrations, reads reduced values. It has been difficult to establish in detail which of the signals from the speed sensors to the engine's RPM regulation malfunctioned at what time. On the basis of the conversation the crew had just before the accident, the AAIB/N assumes that the GOV light was lit for short periods. This indicates that one or two of the three channels were out of service for periods. The

short period in which Ng 2 dropped, immediately after the shaft fracture, indicates that the regulation system reacted normally to information about increasing Nf 2. Since Ng 2 again began to increase to 104%, this indicates that both the regulation and control systems had lost all RPM information. In the opinion of the AAIB/N, this can be explained by the high level of vibrations in the area at the time. This was because the Bendix shaft had broken but, for a short period, continued to rotate at a speed of around 23 000 revolutions per minute. The vibrations led to the rear section of the power turbine shaft, containing the phonic wheels, beginning to rotate with a displaced rotational centre. This resulted in the phonic wheels touching the speed sensors so that these became ground down (see figs. 3 and 61). As a result of the phonic wheels rotating out of centre and the speed sensors becoming shorter, the signal strength dropped away from the speed sensors to a level that was not recorded by the EECU.

- 2.3.11.2 The AAIB/N believes that the RPM information for the engine's system for regulating the power turbine RPM (Nf) under normal conditions, is recorded in a simple and secure manner, but that there was a failure in this case. Since it is difficult to prevent failures in systems completely, it is an important principle to limit the consequences of a failure. In this accident, the regulating logic in the EECU and the engine's system for RPM regulation are the kinds of factor that determine the outcome when the system for RPM regulation fails. These two factors are discussed in the paragraphs below and the AAIB/N believes that, first and foremost, the manufacturer should focus attention on these.

2.3.12 Regulating logic in the EECU

As a result of the fact that the EECU lost RPM information (Nf), this reached the hydro-mechanical stop, i.e. it requested 104% Ng (max power). The engine manufacturer has explained that this gave security against loss of engine output in the event of loss of Nf signals. The accident involving LN-OPG has shown that this regulating logic may be flight safety critical. The AAIB/N has given advice to the engine manufacturer in which a re-evaluation of the logic in the EECU was suggested (see paragraph 4). According to the engine manufacturer, this has led to the implementation of a comprehensive rebuild of the EECU. One result of this is that Ng will be reduced if the EECU loses all Nf information.

2.3.13 The engine's overspeed protection

The general pattern of damage on the engine's turbine housing and analyses of the sound pattern recorded by the CVR indicate that the power turbine in the R/H engine was exposed to overspeed. This was confirmed by measurements that showed an increase in the diameter of the front labyrinth seal for bearing no. 6. Examinations carried out by Turbomeca show that the EECU did not record any overspeed. It follows from this that the system for overspeed protection did not actuate and close the Overspeed Shut-off Valve, despite the engine's power turbine having reached a rotation speed of approx. 175%. The AAIB/N believes that the same failure mechanism that knocked out the system for RPM regulation also contributed to the non-actuation of the overspeed protection. This shows that the method for recording the rotation speed of the power turbine has a fundamental weakness, as it has been used here, and that one

critical failure can put both systems out of action. The AAIB/N understands that a change to the engine in this area would mean extensive rebuilding, but the solution used on the Makila engine, with shared components for speed detection for RPM regulation and RPM limitation, should be avoided. The safety of the engine should therefore be subject to a total re-evaluation.

2.3.14 Protection against the engine's turbines

- 2.3.14.1 A turbine that rotates at great speed, as in this case, stores energy that represents a major hazard if the energy is released in an uncontrolled manner. To reduce this hazard, the turbine can be protected and with vital structures and systems positioned at a safe distance. The containment rings that Turbomeca has placed on the outside of the turbine housing are designed to withstand the loss of individual turbine blades. The AAIB/N believes that the positioning of potentially hazardous components (such as turbines) should be given a great deal of attention with regard to the damage they can cause. This applies in particular to aircraft used for civil passenger transportation. The AAIB/N believes that the design used on the AS 332 in this area contains a number of unfortunate factors, including the proximity of the turbines to the passenger cabin and the minimal distance between the engines. Not least, the flight control rods to the main and tail rotors are positioned very close to the engines.
- 2.3.14.2 Trials in the USA have shown that it is possible to enclose the engines so well that all energy from turbines can be absorbed. Even though this is at the experimental stage at present, the AAIB/N believes that the method could increase safety in future helicopter designs. Other solutions might be to allow the turbine blades to be torn off and ejected towards a shield before the actual turbine wheel fails, thus reducing the total amount of energy released. The AAIB/N believes that methods such as this, for protecting against uncontained engine failure, are particularly relevant to helicopters which are to be used for civil passenger transportation. However, this should be evaluated and viewed in the context of the engines' location in relation to safety-critical components.

2.3.15 Positioning of vital controls

- 2.3.15.1 If the flight control rods had not been cut, the damage to the two engines and the helicopter would not necessarily have led to loss of control and therefore to loss of life. To start with, the helicopter was at an altitude that would have made it possible to carry out a controlled autorotation and emergency landing on the sea. In addition, it was equipped with buoyancy elements, communications/emergency beacon equipment and two rafts. Previous experience has shown that this helicopter type could keep afloat on the sea for several hours even in sizeable seas.
- 2.3.15.2 The rods that transmit the crew's control signals from the cockpit to the main rotor and the tail rotor are located in the cabin roof very close to the R/H engine. This makes the rods vulnerable to damage in the event of serious incidents in the engine (uncontained engine failure). Each one of these rods, and in particular the rods for the main rotor, are absolutely crucial to the control of the helicopter. The AAIB/N is aware that it is part of the complex nature of a helicopter that many of the components are critical, (i.e. that a failure in the component can lead to fatal consequences) and that it is often

impossible or difficult to build in relief functions or double systems for these. The AS 332L1 helicopter type has its origins in a helicopter designed for military purposes more than 30 years ago. During the period that has passed since then, certification requirements have, in general, become stricter and a higher standard of flight safety is expected. The AAIB/N believes that stricter requirements should be set for the protection of vital controls on those helicopters that are designed today for use in civil passenger transportation, than were applicable when the AS 332L1 was certified.

2.4 Splined sleeve

2.4.1 Introduction

The investigation has discovered that cracks, with one or more initiation points, began in the lower area of active teeth surfaces on teeth nos. 6, 7, 14 and 15 on the R/H splined sleeve. Further cracking of the splined sleeve, cracking of the splined flange and the fracture of the Bendix shaft followed after this. The cracks in teeth 6, 7, 14 and 15 arose after the teeth had been subject to considerable wear, probably right through the hardmetal coating in some places. There is reason to believe that this wear formed the initiation point for the crack formation. All cracks in the splined sleeve arose as a result of fatigue and they propagated at almost constant speed. There has been no success in establishing with any certainty what caused the wear and the subsequent fatigue. To chart the possible influencing factors, the AAIB/N has carried out a systematic overview of possible faults and influences on the R/H splined sleeve. Below is an analysis of each individual element.

2.4.2 Possible external influences

2.4.2.1 *Corrosion*

Considerable areas of fretting (traces of mechanical wear) and fretting corrosion have been detected on the splined sleeve. By far the largest part of this originates from the period after the splined sleeve and splined flange had begun to crack. Other corrosion found on these parts originates from the time spent in sea water after the accident. Apart from initial mechanical wear on active teeth surfaces, with possible fretting corrosion, nothing has been found to show that the area had been exposed to corrosion caused by salt or other chemical environmental effects before the formation of the cracks.

2.4.2.2 *Contamination of the splined sleeve area*

The splined sleeve is well protected against foreign objects and chemical attack. The liaison tube encloses the area completely and this is again enclosed by the engine's exhaust pipe. The AAIB/N has found nothing to indicate that contaminants were able to gain access to the splined sleeve while operating. During maintenance work, such as the last inspection of the coupling on 22 August 1997, foreign objects may, however, have been able to penetrate the area. The investigations and analyses that have been undertaken have not detected any. Neither does the AAIB/N have any indications that

wrong chemicals or other harmful materials have been introduced during the maintenance work.

2.4.2.3 *High temperature*

No signs of overheating or structural defects caused by heat have been detected in the material in the component.

2.4.2.4 *Overloads due to overtorque*

According to HS, no overtorque had been reported on the engine/transmission on LN-OPG in the last year prior to the accident. The AAIB/N believes that it is hardly probable that the helicopter had been subject to considerable overtorque without this having been reported. The Bendix shaft and the MGB are components which, according to ECF, must be inspected in the event of overtorque. However, the AAIB/N finds it hardly probable that such a case of overtorque would set in motion a process of fatigue and wear as was the case here. The AAIB/N has therefore not put any more resources into investigations concerning this.

2.4.2.5 *Torque-pulsing transferred from failures in the engines*

It is known that failures in the combustion section and the turbine on certain types of engine can create torque-pulsing in the output shaft. There is no record of the Makila engine having had problems of this type, and no other failures in the engines have been found other than those originating from the accident. Such a possibility is therefore assessed as being hardly probable.

2.4.2.6 *Torque-pulsing due to influences from the main gearbox (MGB)*

The AAIB/N believes that any pulsing torque caused by the MGB must originate close to the splined sleeve and could not under any circumstances come from the gearbox after the transmission lines from the R/H and L/H engines are connected. Geometrical deviations in gears can be examples of such sources. In such case, the overload from this type of pulsing would be equal on the R/H and L/H sides. To achieve pulsing that is forwarded to the splined sleeve and is not damped by the mass in the rotating parts, the deviations causing the pulsing must be considerable. Checking the rotating parts before interconnection (the input pinion, 8 000 RPM wheel, torquemeter shaft, free wheel shaft and free wheel gear with associated bearings) disclosed no significant deviation apart from the wear on the teeth on the R/H input pinion and the R/H 8 000 RPM wheel. In all probability, the wear is directly related to the high frequency vibrations that were recorded. Because it is difficult to differentiate high frequency pulsing in torque from, for example, vibrations. The topic is discussed in more detail under subparagraph 2.4.2.15.

2.4.2.7 *Loadings applied from the splined flange*

Calculations carried out by ECF have shown that the fatigue limit for the splined sleeve can be reached if the surface of the splined sleeve contains fretting and if the angle between the splined sleeve and the splined flange is 10' or more. This type of angle can

be obtained if the splined sleeve and/or the splined flange have been worn sufficiently. This focuses attention on the status of the splined flange.

The results documentation from the 1 200 hour inspection of the Bendix shaft which was carried out prior to the installation, does not provide any information regarding control measurements of the splined flange in accordance with Work Card 63.10.00.701. It would therefore be natural to assume that the wear was found to be so minor that further control measurements were assessed as superfluous. There is nothing to indicate that the splined flange was disassembled from the Bendix shaft after this inspection. The AAIB/N therefore believes that, in all probability, the splined flange was within the tolerances specified by ECF during installation in the helicopter.

Prior to the accident, the splined flange was last available for inspection during the inspection of the coupling between the Bendix shaft and the MGB on 22 August 1997. MET 63.10.00.602 paragraph 4 refers to a general visual inspection of the splined flange without this being disassembled. Here, specific requirements are only given for an inspection of "bore C". The AAIB/N believes that the natural thing would be to examine Work Card 63.10.00.701 to investigate the wear measurements only if wear was detected on the teeth of the splined flange, and that it would not be natural to carry out such verification of the wear measurements if the splined flange appeared not to be worn. It can be difficult to inspect the inside of the splined flange without using e.g. a mirror, especially if the engine is not lifted out of position. The investigation work has discovered that HS cannot document the fact that the splined flange was maintained in accordance with the requirement contained in MET 63.10.00.602. The aircraft technician who took part during the inspection on 22 August has declared to the AAIB/N that he undertook a general inspection of the splined flange before the L/H engine was installed. He did not notice anything in particular during this inspection. To a certain extent, this can be confirmed by the calculations that DNV carried out, which indicate that the component began to crack approx. 9 days after the inspection. At the time the cracking started in the splined flange, the recorded vibration level from the area had already risen appreciably, which might be an indication that the cracking of the splined sleeve had begun. This provides grounds for excluding the possibility that the loadings on the splined sleeve arose as a result of the splined flange already having cracked. However, the inspection that was carried out does not provide any grounds for determining the level of wear on the internal "teeth" on the splined flange. Consequently, the component's status and effect on the splined sleeve is unknown.

The AAIB/N believes that the surface coating on the splined sleeve had considerable defects such as scratches, peeling and lamination when the NDT inspection was carried out. Even though these were defects that could not be detected by the described NDT inspection, they may have led to high levels of wear on the splined flange. Wear may have been caused by loose tungsten carbide particles being pressed into the surface of the splined flange, thus creating crack initiators for the break-up of the component. Furthermore, loose tungsten carbide particles combined with lubricant might create an effective abrasive paste. It is not possible to state anything with certainty regarding the degree to which the disassembly and inspection affected the ability of the components to abrade one another and thereby the speed of degradation of the coupling. However, it is known that components that have adapted themselves to one another may be

subject to increased mutual wear for a period after they have been disassembled and then re-assembled. By a collective assessment, therefore, the AAIB/N believes that it is not possible to exclude wear and damage on the splined flange from having contributed to the failure of the coupling between the Bendix shaft and the MGB.

The investigation shows that maintenance of the splined flange has not been given much attention by either the helicopter manufacturer or the company. This contrasts with calculations that show that high levels of wear on the component affect the splined sleeve. The AAIB/N is therefore of the opinion that there should be a critical review of the maintenance requirements for the splined flange.

2.4.2.8 Loadings applied from the input pinion

Investigations have shown that the input pinion sustained no damage and that the lock nut had the correct tightening moment. Another factor indicating that the fatigue cracks cannot be linked to the input pinion, is that the cracks started externally on the splined sleeve and not internally in the mating surfaces with the input pinion.

2.4.2.9 Loadings applied from the lock washer and circlip

It is known that a splined sleeve can be damaged when the lock washer is installed and that this can lead to cracks in the cylindrical front end of the splined sleeve. The investigation has shown that the fatigue cracks in the splined sleeve started centrally in the spline area and then developed forward towards the edge and the lock washer. The AAIB/N therefore believes that the cracks cannot be linked directly to loadings applied by the lock washer when it was being installed.

The reported incident from N171EH in the USA has shown that the lock washer can come loose without falling out. On that occasion, the helicopter had only flown 13.3 hours after 0.07 IPS had been measured during a vibration check. This indicates that the lock washer was not loose when the checks were carried out, or that a loose, but centred lock washer produces vibrations that are not picked up by the instrumentation.

However, the AAIB/N believes that the possibility cannot be excluded that a loose lock washer might lead to considerable vibrations, even if it is held in place in the splined sleeve and that, over a period of time, this might damage the splined sleeve. However, the natural thing would be for a lock washer that had been loose for some time to leave characteristic traces in the micro splines on the splined sleeve and/or lock washer and for the loadings, which the vibrations would entail, to give rise to cracks in the cylindrical front end of the splined sleeve. No such traces were found on LN-OPG. The traces that were left on the lock washer belonging to LN-OPG indicate that the part had gradually been tilted in the splined sleeve and that it had been sitting relatively firmly between each stage of movement. In the opinion of the AAIB/N, this difference in damage pattern shows that it was not the same mechanism that released the lock washer on N171EH and LN-OPG, and that the fatigue cracks on LN-OPG cannot be linked to a loose lock washer.

2.4.2.10 *Vibrations transferred from bearing failure in the engine*

A reported incident of which the AAIB/N has become aware has shown that bearing failure in the power turbine can lead to vibrations of such force that the GOV and OVSP lights come on and the speed sensors are damaged. Only the outer bearing race from bearing no. 5 was found after the accident. Bearing no. 6 was found complete. There is nothing to indicate that these bearings were damaged before the engine reached overspeed. The AAIB/N believes that damage to the power turbine's bearings can lead to vibrations in the drive train. However, it is not probable that this type of degradation of a bearing would have been happening over a period of time without it being detected in some other manner such as the observation of oil leaks or chips on the chip detector. The AAIB/N has no details of any such problems on LN-OPG and the chip detectors had no contamination originating from bearing degradation. Bearing failure is therefore excluded as a contributory factor.

2.4.2.11 *Vibrations transferred from the power turbine*

Only fragments of the R/H engine power turbine were found after the accident. However, the AAIB/N believes that it is not probable that an imbalance in the power turbine could have led to fatigue damage in the splined sleeve without several other components in the area showing traces and damage that could be directly linked to this.

2.4.2.12 *Imbalance in the splined flange*

Since the splined flange has sustained major damage, it has not been possible to establish the component's balance in the period of time before the accident. However, examinations of the part have not disclosed anything that might indicate that it was in imbalance before it began to crack. The bolts that held the splined flange were found to be normally tightened, without the bolts or holes showing any signs of fretting. On the assumption that the vibration check after the inspection of the coupling on 22 August gave a result of less than 0.65 IPS, it is hardly probable that this changed afterwards due to the splined flange. The AAIB/N therefore believes that the fatiguing of the splined sleeve cannot be linked to any imbalance or installation fault on the splined flange.

2.4.2.13 *Imbalance in the Bendix shaft*

The R/H Bendix shaft sustained such major damage that it has not been possible to establish the component's balance prior to the accident. The damage which has been found on the shaft can be explained as being due to the accident. The bolts that connected the Bendix shaft to the engine were found to be correctly fitted and without the bolts or holes showing any signs of fretting. On the assumption that the vibration check after the inspection on 22 August gave a result of less than 0.65 IPS, it is hardly probable that anything entered the shaft or that anything else relating to the Bendix shaft changed afterwards. The AAIB/N therefore believes that the fatigue of the splined sleeve cannot be linked to any imbalance or installation fault on the Bendix shaft.

2.4.2.14 *Imbalance from the input pinion*

ECF has set a limit value of 0.12 mm (measured on the splined sleeve) for checking shaft eccentricity on the input pinion (concentricity check). Control measurements undertaken after the accident have shown that the R/H input pinion (without the splined sleeve) has an eccentricity of 0.02 mm. No signs of any installation faults have been found between the input pinion and the splined sleeve, or dimension faults on the splined sleeve. The AAIB/N therefore believes that the input pinion was within the tolerance requirements with regard to eccentricity, and that it was consequently not the cause of vibrations or increased wear.

2.4.2.15 *Vibrations from rotating components in the main gearbox (MGB)*

During the disassembly of the MGB, no bearing damage was found that might indicate any significant imbalance from rotating components. Neither were any chips found on the magnetic plug indicating any bearing damage or other form of wear on components made from magnetic materials. The exact status of MGB no. M170 before the accident cannot be reconstructed or verified. The investigation concerning the MGB must therefore, to a considerable extent, be based on assumptions and experiments with equivalent components. For the R/H splined sleeve to be subject to an exclusive overload in preference to the corresponding component on the L/H side, the loading must have originated in the area before the transmission line from the R/H and L/H engines is connected to a common shaft. This focuses attention on the gearbox's R/H input pinion, 8 000 RPM wheel, torquemeter shaft and free wheel with associated bearings.

On several occasions after the accident, the AAIB/N obtained information that there can be sources of considerable vibrations inside the main gearboxes on Super Puma helicopters. In particular, this includes information from the Swedish Armed Forces, the troubleshooting on MGB no. M136 and examinations carried out on the main gearbox from LN-OPG. Examinations carried out in Sweden show that some components have a G-grade that is higher than might be expected in accordance with ISO 1940/1. However, it has been stressed to the AAIB/N that it has not been possible to link high levels of imbalance on individual components to problems experienced with individual gearboxes. The investigations which have been carried out on gearboxes M136 and M665 show, however, that certain combinations of input pinion/8 000 RPM wheel produce higher levels and different vibrations than might be expected to be normal. The limited statistical material that exists with regard to what is normal during such investigations is partly supported by the analyses carried out by GKN Westland Helicopters. These analyses show that the gearbox in LN-OPG (no. M170) differed in significant ways from the other gearboxes from the HS fleet of helicopters that were investigated.

ECF has stated that a rough surface on the teeth on the input pinion may cause abnormal wear on the teeth of the associated 8 000 RPM wheel. This has previously been a problem for which corrections have been tried. More recent examinations carried out by ECF show that there continues to exist a problem linked to the surface of the input pinion. It is highly probable that this phenomenon is the cause of the defects exhibited

on the R/H side of the MGB on LN-OPG. Variations in wear (pitch error) on the teeth on the R/H 8 000 RPM wheel produce a pattern such as that shown in fig. 59. ECF has no explanation for why a gear with 31 teeth (input pinion) can leave a cyclical wear pattern on a gear with 89 teeth. The AAIB/N believes that these cyclical variations in pitch error may form part of the explanation for why, in the gearboxes, vibration frequencies arise, which cannot be directly explained by rotation speed or the number of teeth on a gear. (Ref. examinations undertaken by GKN Westland Helicopters and tests on gearboxes nos. M136 and M665 in subparagraph 1.19.)

Based on these details, it is possible to trace a link from the rough surface on the teeth of the input pinion via pitch error on the 8 000 RPM wheel to high, varying and unexpected vibration frequencies recorded by instruments on the gearboxes. For these vibrations to be capable of damaging the splined sleeve, they would have to be transferred to these components with sufficient energy. Hammer tests have indicated that the resonance frequencies (natural oscillations) of the 8 000 RPM wheel and the input pinion are outside the frequencies in question. The same tests also showed that the gearbox housing principally acts as a damping material at the relevant frequencies. The hammer tests on the torquemeter shaft and the Bendix shaft do not exclude the possibility that the resonance frequency for these components might harmonise with the vibration frequencies that could arise in the input pinion / 8 000 RPM wheel combination. Even if hammer tests on individual non-loaded components produce great uncertainties, there appears to be a theoretical possibility that vibrations, arising in the combination of input pinion / 8 000 RPM wheel, may be transferred to the splined sleeve via shafts and gears or the gearbox housing. There is also a lack of certainty linked to the level of energy which must be transferred to the splined sleeve in order to inflict damage.

In this investigation, the AAIB/N has not made any discoveries that can link, with any certainty, vibrations from rotating components in the MGB to the accident involving LN-OPG. However, it has been found that individual gearboxes for the AS 332L1 can sometimes produce unusual and powerful vibrations. In addition, it is striking that 7 out of 17 reported cases (see subparagraph 1.6.7.2) of failure in the shaft coupling between the engine and the MGB, are linked to three input pinions. Such a coincidence may be explained if the problem is linked to vibrations generated by certain combinations of input pinion / 8 000 RPM wheel. Why vibrations in the MGB on LN-OPG could potentially lead to fatigue cracks in the splined sleeve must be viewed in the context of the findings that have been made regarding the R/H splined sleeve (see subparagraphs 2.4.3.7, 2.4.3.8 and 2.4.3.9). The AAIB/N has not gone any further in investigating the effect of these vibrations and cannot draw any final conclusions from this.

The Board believes that Eurocopter, in collaboration with the civil aviation authority of the state of design, must continue the work of investigating vibrations from the MGB to clarify whether this might affect the airworthiness of the helicopter.

2.4.2.16 *Vibrations originating from the main gearbox (MGB) attachment*

The low-frequency vibrations, normally occurring in a helicopter, are generated by the main and tail rotors. The AAIB/N believes that it would be difficult for these vibrations

to damage the splined sleeve directly, and that any abnormal vibrations in that respect would also make themselves evident in other ways, such as by abnormal wear on mounts and dampers. Low-frequency vibrations transferred to the MGB could, in serious cases, probably lead to loadings and increased wear in the gearbox attachment (suspension bars and titanium plate). Movement between the MGB and the engines must be absorbed by the joints in the liaison tube and the bellows in the Bendix shaft. An unusual amount of movement in this area should have led to increased wear in the joints in the liaison tube. The AAIB/N has found no information to indicate that vibrations or wear in the attachments of the MGB have been a problem on LN-OPG before the accident. On the other hand, examinations of the joints in the liaison tube have shown that the joint in the R/H liaison tube has considerable wear in two out of four bolts including linings. The AAIB/N finds it probable that this wear is a result of the increasing vibrations in the area that were recorded by HUMS in the days prior to the accident.

A high level of vibration between the helicopter and the MGB may be caused by, or lead to, play in the gearbox attachments. Examinations of the attachment of the suspension bars show that they did not exhibit any abnormal play. Neither did the flexible titanium plate show any signs of abnormal movement at its attachment points. The AAIB/N believes therefore that the splined sleeve was not affected by an abnormal amount of movement or vibration in the MGB attachments.

2.4.2.17 Installation failure between the engines and the main gearbox (MGB)

The helicopter suffered so much damage after the accident that it was not possible to check the mounting positions on the MGB or the engines. The AAIB/N is not aware that any installation failures had been recorded on LN-OPG. In the opinion of the AAIB/N, an angle error between the MGB and the R/H engine would principally give rise to increased loading on the bellows in the Bendix shaft and on the joints in the liaison tube. Because there is nothing at the liaison tube to indicate that the joints have been operating outside their normal limits of 2°, the AAIB/N believes that any possible angle error was not large enough to apply a load on the splined sleeve.

The AAIB/N opinion is that the two rivet heads found lodged between the firewall flange and the MGB came there as a result of the accident (see subparagraph 1.16.4.8). AAIB/N finds no logical explanation for these rivets failing due to overload, and thereafter becoming lodged in the actual position as a result of normal maintenance work. It is the opinion of AAIB/N that even fretting at the dowel pins and the mating surfaces is no clear sign of unusual movements in that area before the splined sleeve started to crack. A high level of vibration estimated to exist the last 30 flying hours before the accident, combined with a significant level of movement between the components in the area during the accident sequence, make a significant level of fretting likely. The position of the two rivet heads can be explained by an overload of the tie-bolts and the firewall at an early stage of the break up sequence. The rivet heads were then released at the same time as the tie-bolts were stretched sufficiently to allow the rivet heads to enter the area between the firewall flange and the MGB. Hammering then flattened the rivet heads. In the AAIB/N's opinion a condition for this to happen

was that the liaison tube was exposed to heavy vibrations in a period still attached to the MGB.

2.4.2.18 *Installation damage caused to the splined sleeve*

No damage attributable to the installation of the splined sleeve on the input pinion or the installation of the lock washer has been found on the R/H splined sleeve. Neither has any other damage been found that can be related to incorrect use of tools or similar which has had an influence on the cracking of the splined sleeve. According to a collective assessment, the longitudinal scratches found in the hardmetal coating cannot originate from the installation of the engine. During this type of installation, any grains of sand or loose grains of tungsten carbide would be crushed or pressed into the material on the splined flange without damaging the coating on the splined sleeve in the manner exhibited in this case. In addition, it is difficult to explain how vertical and curved scratches could be created by a rectilinear assembly and disassembly of an engine. The AAIB/N therefore believes that the cracking was not due to any installation damage caused to the splined sleeve.

2.4.2.19 *Deficient lubrication of the splined sleeve*

It has not been possible for the AAIB/N to establish by analysis the exact type or quantity of lubricant which had been used on the splined sleeve on LN-OPG before the accident. According to details supplied by HS, Molicote G Rapide + was used. Analyses of the residue of the lubricant that was found after the accident make this probable. The fact that lubricants were found, particularly in the splines on the splined flange, even after the loading to which the components had been exposed, indicates that sufficient lubricant had been present. The AAIB/N therefore believes that deficient lubrication was not a contributory factor.

2.4.2.20 *Missing O-ring*

The investigation has discovered that no O-ring, type MS9388-133, had been fitted to the R/H splined sleeve as assumed. Tests carried out by ECF show that this increases the freedom of movement between the splined flange and the splined sleeve (tilting) by a factor of 1.2 under normal operating conditions. The test bench running of MGB no. M665 has shown that the O-ring did not influence the vibration pattern in a degree worth mentioning. Small variations have been observed, but it has been difficult to distinguish this from random variations. Details supplied by ECF show that the O-ring can protrude by between 0.27 and 0.52 mm above the surface of the splined sleeve depending on production tolerances. In addition, there are the production tolerances on the splined flange and natural variations in the surface compression of the O-ring as a result of ageing. In the opinion of the AAIB/N, these factors provide a degree of uncertainty for which the tests has not made allowances. According to ECF, the surface coating on the splined sleeve is highly resistant to wear. The factory is able to show that splined sleeves have operated for 3 000 flying hours or more, without wear being exhibited. A freedom of movement that increases by a factor of 1.2 does not necessarily give corresponding increased levels of wear. If, nevertheless, it is assumed that there is linear conformity between the freedom of movement and the wear, the AAIB/N

believes that an increase in normal wear by a factor of 1.2 is not sufficient to degrade such a resistant coating in a relatively short time.

The examination performed by GKN Westland Helicopters shows that the last MGB (M170) installed on LN-OPG had an unusual vibration pattern. The AAIB/N does not have sufficient information to be able to form an opinion on how this vibration pattern would have affected the splined sleeve, and to what extent these possible vibrations might have been damped by the O-ring. However, it seems evident that the fatigue cracks in the splined sleeve did not initiate as a result of a missing O-ring, but that the subsequent crack propagation in the splined sleeve may have been hastened by this deficiency.

2.4.3 Possible problems related to the splined sleeve

2.4.3.1 *The component's margins against overload*

After the accident, based on material properties and FEM, ECF calculated the fatigue limit on the internal teeth's on the splined sleeve to be 140 MPa (see fig. 58). Calculations performed by SINTEF show that the part originally has a fatigue limit of 495 MPa. This gives a margin against fatigue that is within normal design standards. However, margins against over loads will be significantly reduced by defects in the surface. The SINTEF concludes that as an example, a pit 14 μm deep with a pit tip radius of 1 μm gives a local fatigue limit of 270 MPa. This shows that even small defects can reduce the fatigue limit considerably. The investigation of the splined sleeve from LN-OPG has shown that large tungsten grains have penetrated the surface of the base material and led to pits (defects) in the range of 14 μm . However, defects caused by plasma spraying and large enough to reduce the components fatigue limit towards a critical level, have not been found. Wear through the hardmetal coating and into the base material seems to be a more likely explanation as to why defects in the splined sleeve can lead to the fatigue limit being reached. From this it can be concluded that the part has sufficient margins against fatigue, as long as the surface coating protects against wear.

2.4.3.2 *Possible stress concentrations*

There is no demonstrated direct connection between cracks in the hardmetal coating and cracks in the underlying base material. In just one example it has been found that cracks in the coating have continued down into the base material (see subparagraph 1.16.4.7). A possible explanation for this is a weak mechanical bonding between the coating and the base material. A crack through the coating will therefore lead to delamination along the crack and thus reducing stress concentrations and prevent the cracks from entering the base material.

The component's contact surface with the splined flange has its highest level of stress concentration around the lower part of the splined sleeve's active tooth surface and, consequently, it is here that the component is most vulnerable to surface faults. This is the area in which the fatigue cracking was initiated. Damage, which is created by wear or sharp impressions from large grains of carbide, will produce high stress

concentration in this area. In its investigations, DNV has demonstrated clear signs of wear in this area (see subparagraph 1.16.1.2). The AAIB/N concludes therefore that cracks started in this area due to the combination of major wear in an area of highest stress. It has not been proven whether, in addition, there were any large, sharp impressions from grains of carbide within the same area.

2.4.3.3 *Incorrect geometry on the splined sleeve*

Control measurements undertaken by DNV in the selected, undamaged areas of the splined sleeve have not disclosed incorrect geometry in relation to the design drawings. It is therefore highly unlikely that the geometry of the component had diverged significantly prior to the cracking.

2.4.3.4 *Incorrect chemical composition in the splined sleeve*

Analyses undertaken by DNV show that the chemical composition of the splined sleeve is in accordance with the specifications given by ECF.

2.4.3.5 *Failure in heat treatment and material structure of the base material in the splined sleeve*

Examinations undertaken by DNV have not found any variance from specifications issued by ECF with regard to the structure and hardness of the base material in the splined sleeve. The AAIB/N therefore concludes that the material in the splined sleeve complies with the specifications.

2.4.3.6 *Damage inflicted on the splined sleeve prior to application of hardmetal*

ECF has stated that some damage on the splined sleeve was corrected before the hardmetal was applied (see subparagraph 1.6.7.3). This damage cannot be linked to the accident. The investigation has found nothing to indicate that the cracking of the splined sleeve was due to other such damage on this component.

2.4.3.7 *Choice of type of hardmetal coating*

To obtain high wear resistance on the surface, ECF chose to apply tungsten carbide by means of plasma spraying. ECF has stated that the coating was selected on the basis of experience gathered from quite different components used on other helicopters. The AAIB/N is of the opinion that the components and the splined sleeve cannot be compared, and that the choice of coating and method was not necessarily ideal in this case.

According to the specifications, the hardness of the coating must be 1 050 – 1 200 HV_{0.3}. This is hard in relation to the hardness of the base material in the splined sleeve, which must be 321 - 360 HB. The grains of tungsten carbide in the selected hardmetal coating vary greatly in size. The grain size of the spray powder has not been described in the specification. The AAIB/N considers this to be a deficiency in the specification. The examination carried out at DNV has shown that the coating contains grains of tungsten carbide that have a larger diameter than the thickness of the coating.

The coating has not been machined in the splined area. Consequently, grains that protrude above the surface of the coating experience greater compression than the surrounding areas. Hard tungsten carbide grains that are sprayed onto the base material can therefore be pressed down into the softer base material and inflict sharp impressions and local stress concentration. The point loading on a grain can also lead to the grain coming loose and cracks being initiated in the hardmetal coating. Together with lubricants, loose grains can create an abrasive paste. This has been shown as the coating found on the splined flange contained tungsten carbide, amongst other things. This may, however, stem from the general breakup of the splined sleeve at a late stage and is thus not necessarily confirmation that an abrasive paste had been formed at an early stage.

A common method that increases the fatigue properties of a component significantly is introduction of compressive tension in the surface by shot peening. This method is frequently used as surface preparation before plasma spraying of highly stressed components. The splined sleeve was not shot peened before plasma spraying. AAIB/N has not calculated this effect on the characteristics of the splined sleeve.

2.4.3.8 *Weaknesses in the hardmetal coating originating during application*

Praxair did not prepare a sample for each plasma spraying. There is therefore no traceability for individual splined sleeves and, consequently, the AAIB/N cannot compare the status of the hardmetal coating after the accident with the coating straight after spraying. During the examination of the coating, several divergences from normal practice were discovered:

- a measurement was made of the thickness of the coating on the parts of teeth that were not affected by wear. The thickness varies between 14 μm and 32 μm . This is outside the specified value of 25 $\mu\text{m} \pm 5 \mu\text{m}$. In those cases in which the coating is thin, the general problem of large grains of carbide increases. At the same time, the wear resistance will diminish and holes appear in the coating within a shorter time.
- the examination has shown that the porosity of the coating is considerably above the tolerance specified. Previous experience of plasma spraying shows that values of below 1.0% are difficult to achieve. An exceptionally good process therefore has to be created to achieve values of 0.7 - 1.0%. DNV has not quantified the porosity exactly because of the great difficulties involved in doing so. The observed porosity plays a part in reducing the strength of the coating and makes it more vulnerable to damage.
- the examination has shown local lamination in the hardmetal coating and deficient bonding between the base material and the hardmetal coating. The specification requires 100% bonding between the base material and the hardmetal coating. The reduced bonding locally in the coating, and between the coating and the base material, reduced the coating's strength and may have led to peeling during normal operations.

The AAIB/N is of the opinion that the differences in the quality of the coating, as mentioned in subparagraphs 2.4.3.7 and 2.4.3.8, are caused by a disparity between the specification, the type of coating selected and the application. Reduced quality is therefore due not to loadings applied afterwards. Divergence from specifications and a generally accepted standard does not seem to be unique to the R/H splined sleeve from LN-OPG. Other splined sleeves examined have also shown variations in the thickness of the coating, lamination and large grains of carbide. If these observed conditions were the direct causal factor in the cracking of the splined sleeve on LN-OPG, there would be reason to believe that the problem would be more widespread. After an overall assessment, the AAIB/N does not regard the hardmetal coating to have been the sole causal factor in the cracking of the splined sleeve. However, it is clear that the aforementioned factors meant that the coating was more vulnerable to loadings than might be expected of a coating that met its specifications and thereby design.

2.4.3.9 *Damage caused to the component after production, but before it was installed in LN-OPG during the last G-check*

The investigation has revealed a large number of scratches on the splined sleeve (see subparagraph 1.16.1.5). These scratches have, in several places, penetrated the hardmetal coating and led to peeling. This is damage which is difficult to explain on the basis of the loadings to which the splined sleeve is exposed during normal operation or prescribed maintenance (see subparagraph 2.4.2.18). Neither is the AAIB/N able to explain the scratches by loads that have occurred in conjunction with the accident. The Board cannot state with any certainty when, where or how this scratches came into being. Neither HS, ECF nor Praxair have given information about maintenance or other work on the component which could leave similar traces. The splined sleeves are not individually numbered and consequently, the history of the component cannot be traced.

The scratches, in combination with the weaknesses mentioned in subparagraphs 2.4.3.7 and 2.4.3.8, can form the basis of a possible explanation of why the splined sleeve began to crack. This can be explained as follows, point by point:

- the examination has shown that parts of the hardmetal have fallen out between adjacent scratches (see fig. 35). If they were to remain lying between the splined sleeve and splined flange, such loose flakes could act as an abrasive agent. In particular, this wear would affect the splined flange, which has a "soft" surface, but it would also be able to accelerate a process of degrading the hardmetal coating. Cracks had started in areas in which wear had penetrated the hardmetal coating and gone into the base material.
- large grains of tungsten carbide would be exposed to point loadings arising when loose flakes and grains are pressed between the splined sleeve and the splined flange. In a thin coating in particular, they can come loose and weaken the hardmetal surface while also creating a new abrasive agent.
- porosity and lamination will accelerate the degradation process.

Two factors might have accelerated further the process of degradation of the splined sleeve:

- the O-ring that was missing has allowed increased freedom of movement between the splined sleeve and the splined flange and has hastened the process in this way.
- the inspection of the coupling between the Bendix shaft and the MGB led to the splined sleeve and splined flange coming into contact in a new way during the subsequent installation even though the same teeth came into contact with one another. This may have led to new points of contact for wear and further degradation of the coating.

The points above give in the opinion of the AAIB/N a considerably weakened hard metal coating. The presence of the aforementioned abrasive paste and operational loadings then led to fretting and the initiation of a series of cracks in the highly loaded area down on the active tooth surface on teeth nos. 6, 7, 14 and 15. Over time, these developed into fractures. The AAIB/N cannot disregard the fact that further loadings, applied by vibrations from the MGB, were necessary for this to have happened (see subparagraph 2.4.2.15).

2.5 An assessment of the period of failure development in the splined sleeve

2.5.1 Introduction

To allow accidents of this kind to be prevented by such means as improving the maintenance procedures, it is important to estimate the period of failure development in the splined sleeve. This may have a part to play in determining the intervals between maintenance tasks. In its analysis, the AAIB/N has emphasised three factors as an aid in the work of assessing this period:

- an assessment of vibration data
- counting the number of lines (cycles) in fracture surfaces
- the inspection of the coupling between the Bendix shaft and the MGB before the accident

For further details, see Appendix E.

2.5.2 Vibration data

2.5.2.1 Vibration data recorded using HUMS show that, during the period following its installation in LN-OPG, the gearbox had a vibration pattern that diverged to a considerable extent from that which, on the basis of experience, might have been expected (see subparagraph 1.19). The vibration level recorded in the area of the R/H engine/MGB began to increase generally around 20 August 1997. According to information supplied from the aircraft technicians involved, the vibration level was

well within the limit value of 0.65 IPS during the inspection carried out on the morning of 22 August. In the opinion of the AAIB/N, this must indicate that the shaft coupling between the R/H engine and the MGB possessed its original geometry, or a geometry very close to this, up until approx. 20 August. On the basis of the vibration data, it is impossible to establish the extent to which the gradual increase in recorded values during the period around 20 August was due to general major wear on the parts concerned, to external influences or to the fact that the cracking of the components had begun.

- 2.5.2.2 The significant increase in vibration level for the R/H engine power turbine recorded between 2 and 3 September cannot be explained with certainty (see fig. 60). However, the AAIB/N assumes that the geometry in the coupling between the splined sleeve and splined flange altered considerably during this period and that the resultant vibrations propagated along the Bendix shaft and/or liaison tube toward the engine. Obvious examples of such alterations might be that the cracks in the splined sleeve reached right up to the front edge of this, in such a way that the lock washer lost its grip, that the cracks on the splined flange split the component correspondingly or that the lock washer had come out of position because of cracking.

2.5.3 Counting lines (cycles)

- 2.5.3.1 The complex pattern of breakup on the splined sleeve prevents a definite estimate of the time taken for the cracking. Even although counting has indicated that the cracks grew with relatively constant speed, the cracks may have followed several different "routes" to create the pattern that was found. By counting lines (beach marks) in the cracks along the shortest possible "route", ECF arrived at 79 lines. This is consequently a minimum figure for the splined sleeve. This method was also used by DNV and was shown to produce results that concur with those of ECF.
- 2.5.3.2 Based on experiences from the Japanese incident (see subparagraph 1.6.7.2). ECF is of the opinion that striations counted in the crack surface, corresponds with the main rotor speed. The splined sleeve from LN-OPG was split by a crack that started in the centre and moved in two directions. Counting striations along that part of the crack that progressed forward is of little value since there is uncertainty about the time when the crack reached the front edge. However, DNV has made counts of striations along the crack that developed backwards and followed the radius all the way. The crack's total lifespan can be established because this crack did not reach the edge before the accident (it has a crack toe). DNV has found this "aft part" of the crack to be 80 mm long. Based on an average of 7 500 striations per mm, the total number of striations will be 600 000. By dividing this by a rotor speed of 265 RPM, the answer will be 2 264 minutes or 37.7 hours. In the AAIB/N's opinion too much emphasis can't be put on this result, as it is based on the assumption that vibrations from the main rotor must be the causal factor for the cracking of the splined sleeve. AAIB/N believes that counting of lines (beach marks) gives a better picture of the time frame. This is based on being able to connect one line to an operational load application. A counting like these by DNV has shown that the crack contained 105 lines. Because this figure is higher than the equivalent for the splined sleeve, 105 lines must form the basis of calculations of the minimum period for development of the crack.

- 2.5.3.3 There is some uncertainty about what one line in the crack surface represents (see subparagraph 1.18.2). The line distances may be randomly controlled, such as by random loadings or resonances in the gearbox, or they may be determined by the operational factors that have affected the helicopter. The theory of random variations in the vibration level in the MGB is supported to a certain extent by the findings made by GKN Westland Helicopters in its analysis of the HUMS data. However, a comparison of the line pattern (see fig. 49) with a visualisation of the helicopter's operational flight pattern (see fig. 52) shows a high degree of similarity. In addition, DNV has found that the line pattern in the crack has periodically coincided with the pattern of flight operations. The lines in the crack also give the impression of being so systematic that it hardly seems probable that they would have arisen as a result of random variations in vibration pattern in the MGB. There is, therefore, reason to believe that the line pattern can be linked to operational factors. In other words, the lines can be linked to operational cycles.
- 2.5.3.4 The conclusion put forward by ECF is that one start-up of the rotor represents one line (cycle). The helicopter started up the main rotor 105 times during the period between 12 August and the time of the accident. This means that the crack in the splined flange developed over a period of 204 flying hours. If, on the other hand, the premise is based on one line representing one departure, it will be seen that the helicopter carried out 105 departures during the period between 31 August and the time of the accident. In that case, this means that the crack developed over a period of 61 flying hours and 35 minutes.
- 2.5.4 The inspection of the coupling between the Bendix shaft and the main gearbox (MGB) before the accident
- 2.5.4.1 The inspection of the splined sleeve was completed on the morning of 22 August 1997 without any cracks being found. Even though experience has shown that the prescribed and used dye penetrant method has difficulties in detecting small cracks (micro-cracks) in the surface of the splined sleeve, it is not probable that the actual breakup of the splined sleeve had started at this time. On the assumption that the splined sleeve began to crack first, or that the splined sleeve and the splined flange began to crack at the same time, it appears absurd that the cracking of the splined sleeve should have been going on for 83 hours (204 hours - 121 hours), or more, at the time of the NDT inspection, without this having been detected during the inspection. This point of view by ECF implies that loose teeth were present at the splined sleeve during the NDT inspection. The consequence of this must be that the NDT inspection as performed had no value, or that it was not performed. The AAIB/N find that both options seem improbable.
- 2.5.5 Summing up
- 2.5.5.1 The results of counting the lines in the crack surfaces differ greatly, depending on whether a cycle is defined as one start-up or one departure. The most precise time perspective can be linked to the crack in the splined flange since only this has a known initiation point and a known point for the last line to be deposited (the crack toe at the

time of the accident). By defining a cycle as one start-up, the counts show that the crack in the splined flange started on 12 August, approx. 204 flying hours before the accident, and approx. 83 flying hours before the NDT inspection. If, on the other hand, a cycle is defined as one departure, the count shows that the crack in the splined flange started on 31 August, approx. 62 flying hours before the accident. There are several factors that make it probable that a cycle should be defined as one departure (landing):

- in Eurocopter's own description of a cycle in connection with assessments of loadings, viewed in relation to operating time, a cycle is defined as one landing.
- if a cycle is defined as one start-up of the rotors, this means that the splined flange began to crack 83 flying hours prior to the NDT inspection being performed. The examination has shown that, in all probability, the splined sleeve began to crack before the splined flange. It therefore appears absurd to believe that HS would have performed an NDT inspection of the splined sleeve without significant cracking of the component, including loose teeth, having been detected.
- if the cracking of the splined flange had been going on for 83 flying hours before the inspection on 22 August, it is reasonable to assume that the cracking would have been detected during the inspection even if elements of the inspection had been omitted.

2.5.5.2 On the basis of this, the AAIB/N believes that the cracking of the splined flange started around 31 August. The first phase of the cracking of the splined sleeve was that teeth nos. 6, 7, 14 and 15 came loose. The AAIB/N believes that it is not reasonable to assume that anything other than possibly some micro-cracks existed at the time the NDT inspection was performed. The examination has shown that, in all probability, the splined sleeve began to crack before the splined flange. It would therefore be natural to assume that the splined sleeve began to crack between 22 and 31 August. This is between 121 and 62 flying hours prior to the accident. In addition, the examination has shown that the first crack in the cylindrical part of the splined sleeve reached the front edge of the component before the crack toe in the splined flange passed outside the same area. Furthermore, it has been shown that the first of three cracks in the splined sleeve, which reached the front edge of the component, arrived at this stage only in the second phase of cracking (as defined by DNV). It is impossible to say anything for certain about the time it took for the first crack on the splined sleeve to reach the front edge. However, the examination has shown that the crack growth was relatively constant in large parts of the splined sleeve. There is therefore some reason to believe that the splined sleeve started to crack several tens of flying hours before the start of cracking on the splined flange.

2.5.5.3 The fatigue cracks arose as a consequence of dynamic loadings over a period of time. In this case, there is reason to believe that the dynamic loadings affected the component for a period before the cracking (an incubation period). It is impossible to calculate the length of this incubation period, only to ascertain that the loadings that led to the cracking of the splined sleeve existed before the component began to crack.

- 2.5.5.4 IHUMS information shows that the level of vibration in the area of the R/H engine/MGB began to increase around 20 August. Data from the accelerometer on the R/H power turbine shows an increasing trend from as early as 18 August. Since the examination has shown that there is little reason to believe that the cracking had started at this time, it would be only natural to believe that the increasing vibrations were due to wear on the splined sleeve and/or the splined flange, or caused by vibrations from the MGB.
- 2.5.5.5 The AAIB/N cannot establish what caused the significant increase in vibration level between the recordings for 2 and 3 September. However, there is reason to assume that there was a marked change in the geometry of the components. Such changes might be the opening of the cylindrical part of the splined flange or the lock washer coming loose and tilting.

2.6 A summary of the analysis of technical factors in sections 2.2 - 2.5

2.6.1 Possible causal factors for the initiation of cracking in the splined sleeve

2.6.1.1 The AAIB/N has been unsuccessful in establishing with certainty what led to the cracking of the splined sleeve, something that then led to the accident. Of the many factors that have been investigated, there are two in particular that have stood out and that cannot be excluded as causal factors:

- the status of the hardmetal coating on the splined sleeve
- vibrations from rotating components in the MGB.

2.6.1.2 The investigation has found several factors regarding the hardmetal coating on the splined sleeve:

- the selected hardmetal coating contains grains of tungsten carbide that, in some cases, have larger diameters than the local average thickness of the coating
- in places, the thickness of the coating is below the specified minimum requirement of 20 μm
- the porosity of the coating has been observed to be significant and far above the specified value of 0.7 - 1.0%
- the investigation has shown local lamination in the hardmetal coating and deficient bonding between the base material and the hardmetal coating
- a series of scratches have been shown to exist in the hardmetal coating. The cause cannot be proven, but the scratches cannot have arisen as a result of the accident. Whole flakes of the coating have fallen out in areas between two scratches where the scratches run close to one another.

Without doubt, these findings all contribute to weakening the hardmetal coating and making the splined sleeve less resistant to loadings than would have been the case with a more ideal coating.

2.6.1.3 Several factors that have been discovered during the work on this accident can be explained by the fact that rotating components in the MGB cause powerful vibrations:

- analyses of HUMS data from LN-OPG show that the level of vibration recorded from the MGB changed considerably in nature and strength in conjunction with the installation of MGB no. M170. The vibration pattern that was recorded from no. M170 was unusual in several ways, in comparison with what was found at HS on other equivalent MGBs.
- a short time after overhaul at HS, MGB no. M136 issued powerful and increasing vibrations recorded by HUMS. Examinations showed that the vibrations were caused by the combination of input pinion / 8 000 RPM wheel on the R/H side, and that these components had wear on the teeth that were assessed by ECF as being over the permissible limit.
- the combination of R/H input pinion / 8 000 RPM wheel from LN-OPG was tested in MGB no. M665. In vibration measurements on the gearbox, this combination showed a vibration pattern that was clearly different to that which was recorded on the L/H side and on the R/H side when the gearbox's original components were in place. The vibration pattern, on the other hand, had much in common with what was recorded on MGB no. M136. The wear on the teeth on the R/H 8 000 RPM wheel from LN-OPG was assessed by ECF as being over the permissible limit.
- 7 out of 17 reported cases of failures in the shaft coupling between the engine and the MGB have been linked to three shaft inputs. Obviously, this may be due to other circumstances, such as shaft eccentricity on the pinion (detected during the Sleeve Concentricity Check), but a probable explanation is that this is due to vibrations that originate in the combination input pinion / 8 000 RPM wheel.

However, it must be underlined that the investigation has not disclosed any direct correlation between wear on the 8 000 RPM wheel and loadings applied to the splined sleeve.

2.6.1.4 The investigation has discovered that O-ring, type MS9388-133, was not fitted to the R/H splined sleeve as assumed. Tests carried out by ECF show that this increases the freedom of movement between the splined flange and the splined sleeve by a factor of 1.2 under normal operating conditions. The extent of this damping effect under normal operating conditions, and how much this type of damping effect affects the wear on the components in question, can be considered to be highly uncertain. The AAIB/N believes, however, that there is no realistic argument to show that the fatigue cracks in the splined sleeve were initiated as a consequence of a missing O-ring. On the other hand, the subsequent crack propagation in the splined sleeve may have been hastened by this deficiency.

2.6.2 The period of fault development in the splined sleeve

- 2.6.2.1 The AAIB/N has tried to establish the time period in which the fault in the splined sleeve developed. In this task, the AAIB/N has placed emphasis on the vibration data recorded via HUMS, examinations of the fracture surfaces of the splined sleeve and the splined flange, and information about the maintenance that was carried out on LN-OPG before the accident.
- 2.6.2.2 On the basis of examinations of fracture surfaces, the AAIB/N believes that the splined flange began to crack around 31 August 1997. Furthermore, the examination has shown that the obvious thing would be to assume that the splined sleeve began to crack before the splined flange. The AAIB/N is of the opinion that it would be unreasonable to assume that anything other than micro-cracks possibly existed in the splined sleeve when this was examined using the dye penetrant on 22 August 1997. It would therefore be natural to assume that the splined sleeve began to crack during the period 22 to 31 August. This was between 121 and 62 flying hours prior to the accident.
- 2.6.2.3 The fatigue cracks arose as a consequence of dynamic loadings over a period of time. In this case, there is reason to believe that the dynamic loadings affected the part for a period before the cracking (incubation period). It is impossible to calculate the length of this incubation period, only to establish that the loadings that led to the cracking of the splined sleeve existed before the component began to crack.
- 2.6.2.4 IHUMS information about the level of vibration in the area of the R/H engine/MGB began to increase around 20 August. Data from the accelerometer on the R/H power turbine shows a rising trend starting as early as 18 August. Since the investigation has shown that there is little reason to believe that the cracking had started at this time, the obvious thing is to believe that the increasing vibrations were due to wear on the splined sleeve and/or the splined flange or to vibrations from the MGB.

2.6.3 Causal factors significant to the course of events

- 2.6.3.1 Under subparagraph 2.6.1, there is a description of two possible causal factors for the splined sleeve beginning to crack, and, under subparagraph 2.6.2, the date when the cracks started has been set at between 22 and 31 August. In the period up to the fatal flight on 8 September, cracks developed in both the splined sleeve and the splined flange without this being noticed or recorded anywhere other than in HUMS, and then in the form of vibration data.
- 2.6.3.2 During the fatal flight, the cracking led to powerful vibrations in the Bendix shaft, which in turn led to contact between the phonic wheels and the speed sensors. The engine's regulation and control system then began to lose information about the engine's speed of rotation. The consequences of this were that, approx. 6 mins. and 30 secs before the accident, the crew registered that the OVSP light for the R/H engine lit for a short period. A little later, the GOV light for the R/H engine presumably also lit up. The crew could not surmise the degree of seriousness of these signals and continued with the flight.

- 2.6.3.3 In all probability, the lock washer and splined sleeve then came loose and got into the Bendix shaft. This applied such great loadings to the shaft wall in the Bendix shaft that it burst after a short time. The end of the Bendix shaft that was attached to the engine continued to rotate with the engine and this gave rise to powerful vibrations. These vibrations completely knocked out the engine's regulation and control system. One of the results of this was that the regulation system supplied the engine with fuel to achieve 104% Ng. Since the engine had become free of load due to the shaft fracture, the speed of rotation of the power turbine increased to approx. 175% Nf. At this speed, it was ripped to pieces by centrifugal forces and fragments were ejected with great force from the power turbine's plane of rotation.
- 2.6.3.4 The explosive incident in the power turbine on the R/H engine cut the engine in two, destroyed the L/H engine and cut several of the helicopter's vital control rods. The incident, from when the lock washer entered the Bendix shaft, until the engines were destroyed and the control rods cut, took 3.9 secs. After this, the helicopter was uncontrollable and fell towards the surface of the sea.
- 2.6.3.5 An analysis of causal factors has detected 14 sometimes complex and composite factors that were absolutely crucial to the outcome of the accident (see subparagraph 2.3). The accident could have been prevented if only one of these had been dealt with in some other way. This links the accident to design and the risk analyses performed at the helicopter's design. Risk analyses cannot take in all possible factors and approaches to problems. It cannot therefore be expected that the mechanisms behind the cracking of the splined sleeve would have been identified in this type of risk analysis. The AAIB/N, however, considers that questions can be raised regarding why weaknesses in the shaft coupling between the engines and the MGB, weaknesses in the system for regulation and limitation of the engine's speed of rotation, and the deficient protection of vital control rods, had not been identified. The AAIB/N is of the opinion that the accident shows, very graphically, a series of latent factors that could have been detected using modern principles of risk analysis.

2.7 Steering documents - the documented quality system, procedures and the people in the process

2.7.1 Introduction

- 2.7.1.1 The investigation has shown that Helikopter Service AS stands out as a professional organisation with controlled processes, prepared procedures, resource personnel and facilities that give a fundamental impression of reliable safety management. The organisation has a written safety policy which forms part of the quality system and largely exceeds the minimum requirements of the civil aviation authorities. The management of the technical department has indicated to the AAIB/N that it has been well spoken of in several contexts, and has also been positively compared with other organisations of the same type. They therefore expressed that they were treated unreasonably when the Norwegian Civil Aviation Authority (NCAA) (before January 2000, cf. subparagraph 1.17.1.1), in two inspection reports in 1997, discussed the engineering organisation in negative terms, particularly in Report no. 97J007 (see subparagraph 1.17.1.3). In some areas, the reports contain remarks/observations that

are in agreement with the impression that the AAIB/N has been left with in connection with this investigation. On its part, HS has expressed the opinion that the reports were conducted properly, but that the company does not share their main conclusions and that these are not representative.

2.7.1.2 Helikopter Service AS has therefore chosen to put itself on a level which, in their opinion, is in the front rank in relevant comparisons. At the same time, the company's chosen safety policy and the management of safety work expressed in the Quality Manual sets strict requirements for a well-functioning organisation with a continuous process of improvement, measurement and communication of safety to the employees. In the opinion of the AAIB/N, it is obvious that an aviation company with high objectives, that wants to portray itself in such a way, must be evaluated and assessed at a high level both by the company itself, by the inspection authority and by the investigation authority. A benchmark is only appropriate for comparison with similar organisations. It is in this kind of context that the AAIB/N considers it natural to put the spotlight on the company's aircraft technical organisation and the documented quality system. Not least, this becomes relevant when, in its own annual report on quality and HES for the year 1999, the company itself expresses the opinion that the company's objectives on safety and quality were not reached, because of events such as the accident involving LN-OPG.

2.7.1.3 The following analysis is characterised both by the observations above and by the fact that the company has had several fatal accidents in which there has been reason to assess the organisation's ability to control safety. However, the AAIB/N has confidence that the management at HS is professional and displays both humility and self-criticism with a view to finding potential safety improvements, not least in the context of the accident involving LN-OPG and the Board's subsequent investigations.

2.7.2 General observations

2.7.2.1 It is important that the objectives are clear before any remedies are selected. HS has clarified its business concept and main objectives in its Quality Manual. To achieve its overall objectives, HS has "an integrated system for quality assurance". This means that the quality system must ensure that activities satisfy the requirements specified by the aviation authority, customers and the company. Among requirements mentioned in the Quality Manual are the provision of safe helicopter transportation (business concept) and that the services must be performed without accidents (a main objective). According to the manual, this must be achieved by systematic organisation, planning, implementation and monitoring of all activities plus documentation and audits. All activities must be carried out under controlled conditions. The term "controlled conditions" is used to mean the establishment of procedures and instructions that establish the method and verification of professional execution and appropriate equipment. It is the responsibility of managers to take care of the quality assurance function within their respective organisational units. This is achieved by the manager having responsibility for setting up and having ownership of the procedures described in the respective Procedures Manuals (PMs). In practice, this means that the respective PMs contain procedures in which the "ownership" lies with several managers.

- 2.7.2.2 In establishing a quality system, it is important to consider carefully the most appropriate way to structure the system's documentation. In a business exposed to risk, it is not only the aviation authority and the customer who must have satisfactory confidence in such a system. It is also important that the system should have a logical structure, be user-friendly and thus understood by company personnel and be actively promoting safety. The people who are to adhere to the quality system must be well informed, trained, motivated, loyal and live in a culture in which the quality system becomes a natural fixed point for everyday work as well as an incitement to steady improvements. The quality system must be monitored on an ongoing basis and the management must constantly assess whether the results correspond to what has been planned and targeted, and whether the system is appropriate for achieving the targets.
- 2.7.2.3 In the case of the accident involving LN-OPG, neither the business concept nor the main objectives were maintained or achieved. Since the means of achieving the objectives are principally described in the technical division's documented quality system (the MOM and PMs), the natural thing would therefore be to take a closer look at the appropriateness, structure and integrity of the documentation.
- 2.7.2.4 In chapter 3 of the MOM, criteria are set up for how and why the technical department's quality system has been established. The system must both document how the quality system is to function and create confidence in aviation authorities and customers that all requirements will be implemented by the organisation, thereby contributing to safe helicopter transportation.
- 2.7.2.5 Maintenance personnel must adhere to the technical division's documented quality system as discussed above. It appears that this documentation system is structured in a satisfactory and recognised manner. (See subparagraph 1.17.2.4).
- 2.7.2.6 However, on closer examination of this system of documentation, it appears to be less appropriate in a number of places. There are examples of ambiguities and deficiencies which make it difficult to have full confidence in it. Below is an analysis of three relevant observations that exemplify this:

2.7.3 Observation 1

- 2.7.3.1 The MOM describes that, for all aircraft types, a Maintenance Requirements Manual (MRM) is issued that must be approved by the Norwegian Civil Aviation Authority. The MRM contains "work cards and forms" which are also used as documentation. The Maintenance Requirement List (MRL) is part of the MRM. The MRL is "...an EDP register which forms the base for the Maintenance Operations System (MOS)" (ref MOM 07-01-10). In PMTD (01-23), it is stated about MRM that the maintenance requirements are recorded in a "computerised requirements register" without other reference. The MOM contains the following concerning EDP-based registers:

"Maintenance Requirement System (MRS):

Future computer based system for accommodation of the maintenance programs (current MRM/MRL requirements (Routine Maintenance)). Only reference to the system is given in MCS."

2.7.3.2 Three different work cards/documentation systems are described in the PMMR:

06-09 (1/9-96) Work Pack System which can only be used for aircraft with an MRM system that is "prepared and updated for integration" and recorded in the MOS.

06-16 (1/4-96) Work Specification (WSP)-Work Specification List (WSPL).

06-19 (1/4-95) Work Card System. It is mentioned here that there must be a transitional phase in which old work cards and forms will be replaced by a "New work card type". In addition, it is stated that the "New Type" consists of "Main Task-Sub Task-Item".

2.7.3.3 Discussion

The maintenance programme for the individual aircraft is documented in the MRM. Only this manual has been approved by the Civil Aviation Authority. The programme has been entered into a computer system (the MRS system) that monitors operating times, issues summary lists for maintenance activities and generates work cards. The MRS system is not described in any way other than that which has been shown in the text above. Procedures 06-9 and 06-16 mention the MOS (Maintenance Operations System). The MRS system must be a "future computer based system". There must be a question mark against the length of time the expression "future" can be included in such documentation without the "obsolescence deadline" expiring. Other than that, there is no description of the MRS system. Neither is there any description of how this relates to the MOS. PMTD 01-23 establishes that all amendments to work cards in the MRM must be approved by the section manager. The AAIB/N understands that this is to be done on the basis of the amendments being quality assured. There is no description of the way in which the section manager should be presented with details of the changes made by the programme engineer, nor the way in which the approvals are to be documented. Otherwise, PMTD 01-23 is not included in the procedure register in the MOM.

The NCAA noted in its report 97J007 that the workshop had not drawn up a progress plan for the transition to the MRS/Work Pack. It therefore appears as if the programmes have been controlled in differing ways for a fairly long time. During conversations with responsible personnel in HS in connection with the investigations surrounding LN-OPG, it was confirmed that there were still several levels on which the maintenance programme was controlled and documented (several work order systems). Since it has been proven that the maintenance programme for the inspection of the coupling between the Bendix shaft and the MGB was revised in a manner that could omit maintenance activities for the entire AS 332 fleet, it appears that there has not been sufficient control during the phase, lasting several years, when there were various work card systems. This has gained expression in the fact that, for a period, aircraft technicians have had an unclear understanding of whether certain items, such as Main Task, must be used or not. In accordance with the procedure in which it is described, Main Task must be a "new type workcard". It is difficult to understand how this type of card could be a new type after the introduction of the Work Pack System as a means of ordering maintenance tasks.

The AAIB/N finds reason to note that it is unsatisfactory that the company has no clear line on how to deal with a relatively long phase involving several valid systems. In particular, it is noted that during such a phase it is especially important to establish quality assurance (for example, quality plans) that ensures, in particular, that there is full control over maintenance of the aircraft. When this has not been the case, it would seem that the quality system has failed in this area. This affected safety.

2.7.4 Observation 2

2.7.4.1 In a previous report (AAIB/N report no. 2/98), the AAIB/N noted that it would be advantageous to review the technical division's documented quality system with regard to accuracy. On that occasion, the company reacted forcefully to the AAIB/N's observations and remarks. The company's internal annual report from 1997 asserts that the great majority of the company's principal manuals are in a good state and provide the management with a good foundation for managing and controlling the company's many activities.

2.7.4.2 Discussion

The accuracy and integrity of the documentation are a very important theme in aviation, since the control documents should be regarded as safety documentation. In the technical division, this applies in particular to the documented quality system, the MOM and PMs. The AAIB/N has reviewed these documents in detail and believes that their status at the time of the accident was not satisfactory. They contained errors and flaws that marred an otherwise structured system. Examples of this would be the use of the wrong organisation codes (no longer applicable), reference to a non-applicable department (Planning Department), missing figures which have been referred to, use of several expressions for the same factors (for example, line stations - secondary bases - secondary stations - temporary bases - temporary line stations) and presumptions that have not been documented (for example, the MRM is "..designed according to a logical method..." and "The maintenance program must only contain items that satisfy MSG-3 Applicability and Effectiveness Criteria"). Several examples can be documented. Therefore, the AAIB/N is really unable to accept that the documented quality system in the technical division was in an absolutely "good condition" at the time of the accident. Questions must be asked as to whether the management, with its obligation to carry out monitoring, is fully justified in believing that the system has fulfilled its purpose as regards achieving its overall objectives, as discussed above. It may be advantageous to subject the system to a thorough review with regard to accuracy and integrity.

2.7.5 Observation 3

2.7.5.1 In conversations with personnel at several levels in the technical division, the AAIB/N recorded that the understanding of the company's integrated quality system, in general, and the technical division's system, in particular, as described via the MOM and PMs are not always equally clear. Similarly, the AAIB/N has recorded the remarks of the NCAA - Section for Aviation Inspection (now the Norwegian Civil Aviation Authority) in its Report 97J025 that the employees' knowledge of routines and

regulations is not satisfactory and that a change of attitude at all levels is required in order to improve the situation.

2.7.5.2 Discussion

As indicated above, it is of predominant importance that everyone with an influence on quality understands the concept of quality selected by the management and accepts it. There are two sides to this type of concept - the processes and the people. A key concept is therefore that documentation which governs quality processes should be unambiguous and understood by everyone. This sets requirements both for training and for forming attitudes. It is said that quality is first and foremost a matter of attitudes - not systems on paper. Nevertheless, the AAIB/N believes that the "paper system" must be updated on an ongoing basis and must be correct - as far as practicably possible - because it should be regarded as safety documentation within an aviation company (see paragraph 2 above). As regards training and motivational work, it has been the experience of the AAIB/N that, on a general basis within the field of quality technology, there are often failures in this area. The experience gained by the AAIB/N in this investigation appears to confirm this. People on several levels within the technical division maintain that the training in the quality system is deficient. The AAIB/N therefore believes that there is reason to point out that there is room for improvement within the technical division as regards the entire concept, both the processes and the attention to attitude formation.

2.7.6 Corrective measures

- 2.7.6.1 During its inspection work, the AAIB/N has been given access to the "Safety Programme for Helikopter Service 1998". The following quotation is taken from one of the objectives in the programme:

"Our control documentation must be descriptive, clarifying, unambiguous and user-friendly." (Translated from original Norwegian)

To implement this, HS made the following resolution:

"We must undertake audits of existing manuals with a view to the simplification of procedures and of the language, in order to achieve better understanding and simpler system maintenance." (Translated from original Norwegian)

- 2.7.6.2 In relation to the observations made by the AAIB/N, and which are referred to in subparagraphs 2.7.1 to 2.7.5, the Board takes a positive view of the improvement activities that the company plans to implement.

2.8 Inspections carried out by the NCAA

2.8.1 General

- 2.8.1.1 Before 1 January 2000, there was one regulatory body for civil aviation in Norway, the Norwegian Civil Aviation Authority [Luftfartsverket]. This was then split into the Norwegian Civil Aviation Administration [Luftfartsverket] and the Norwegian Civil Aviation Authority [Luftfartstilsynet]. Up until 1 January 2000, the Section for Aviation Safety at the Norwegian Civil Aviation Authority carried out inspections on civil aviation companies. As indicated in subparagraph 1.17.1.1, the purpose of such inspections must be to ensure that the given conditions continue to satisfy the regulations after initial surveillance for authority approval to the civil aviation industry has been granted. The assessment of the safety standard is not based exclusively on supervision via inspections (audits), but also on ongoing correspondence, communication and information that takes place between the individual company and the inspection authority. The inspection authority is usually represented by permanent officers who have a number of companies as their own special area. In this way, the officers gain a good knowledge of the companies they normally deal with.
- 2.8.1.2 The AAIB/N has reviewed the aviation authority's inspection reports/audit reports applicable to HS during the period 1990 to 1997. The aviation authority appears mainly to use a system of separate aircraft operations and technical department inspections, but there are also examples of inspections carried out jointly. HS has been approved as regards quality engineering, on the basis of BSL D 1-1 and JAR 145. In the opinion of the AAIB/N, it is essential for safety control systems such as quality systems and flight safety programmes to be devoted particular attention during the aviation authority inspection. The reason for this is that the AAIB/N knows from experience that some inspection activities have suffered from a lack of resources and that it is therefore important to allocate resources to the areas in which they would have the greatest effect. In such a context, an ongoing assessment of the company's control documents and the effect of the quality and safety systems becomes a particularly important task at which to target resources.
- 2.8.1.3 For many years, HS has had an "integrated system for quality assurance" defined in the company's "Quality Manual". This was also applicable before BSL D 1-1 became a reality in 1995. The quality system of the workshop organisation was assessed in relation to JAR 145 and accepted by the NCAA in 1995. The company's quality system was first approved in accordance with BSL D 1-1 in 1997. The approval was based on the quality system that already existed. This system embraces internal controls (Health, Safety and the Environment - HSE) and, from 1998, a specific section on safety management. Formally, the period 1990-1997 was a time in which the company had to adhere to several quality standards. Viewed realistically, it seems as if the company developed its quality system on an ongoing basis and has therefore had the advantage of being "ahead of the game" when formal approvals became relevant.
- 2.8.1.4 In its inspections, the NCAA has periodically touched on the suitability and effectiveness of the quality system by taking up nominated topics and assessing these

against the company's system of manuals, results documentation and internal audit procedures. In reality, this means that both aircraft operations inspections and technical department inspections independently appraise the quality system, or parts of it. On the other hand, there appears to be no collective and overall assessment of the integrity of the quality system, including flight safety programmes and HES. The few joint inspections that have been held, do not seem to include this type of overall assessment. The company's management is obliged, via the selected quality standard, continuously to assess the appropriateness and adequacy of the entire quality system. In the opinion of the AAIB/N, the NCAA ought to have the same requirements in its inspection work; for example, when the NCAA's permanent officers for the company carry out this type of joint review.

- 2.8.1.5 In its standards for aviation authority inspection work, the JAA recommends being strict as regards the content of the aviation companies' control documentation (the manuals). In the manuals, there must be no so-called "superfluous" information; in other words, information that, strictly speaking, is not necessary, does not make sense or is irrelevant. The JAA states that superfluous content in manuals has a tendency to overshadow the information to the personnel in question that they actually need, must understand and must adhere to. Emphasis is also placed on the fact that, despite it being the individual companies that have responsibility for the content of their manuals, the authority must have a thorough knowledge of the company's control documents in order to be able to perform its inspection task. The experience of the AAIB/N, regarding the manuals system in the technical division as at the date of the accident, indicates that the authority should put greater emphasis on the content of the manuals in its inspection work.

2.8.2 NCAA inspection reports from 1997

- 2.8.2.1 As shown under subparagraph 1.17.1.3, in 1997 the NCAA undertook two operations inspections in which the conclusions were particularly critical of the technical division. Among other things, it indicated that there would have to be "a change in attitude among employees at all levels in the company" and that the observations that emerged after the inspections were "symptoms showing that procedures, attitudes, skills and responsibility for work carried out can and must be improved". The NCAA considered it to be disturbing that several factors, also serious, had been indicated in previous reports. The AAIB/N touched on this in its conversations with the company because some observations were in line with observations that the AAIB/N had made, but particularly because such serious conclusions from an inspection authority concerning an aviation company could have an effect on safety matters. The engineering management expressed their great surprise at the comments from the NCAA. Even although they did not recognise themselves, they took the situation seriously. In particular, they believed that many other reports which had been issued on the company over a long period of time did not give the same impression, and that the two reports referred to were special cases and not representative of the company in any area. Furthermore, it was maintained that the number of observations, particularly from the inspection carried out jointly with the FAA, reflected the major resources that were put in during the inspections.

- 2.8.2.2 The AAIB/N has reviewed the 106 observations from the two reports mentioned above. All observations are related to the content of JAR 145 (maintenance organisation regulations) and to the organisation's system of manuals (the MOM, rev. 8). It was difficult for the AAIB/N, in its review of the NCAA inspection reports from the period 1990 -1997, to be able to see a rising trend as regards observations during the period. The year 1997 must therefore be assessed as special in this type of context. The large number of observations that were reported can also be seen in the context of the resources that were put in. The AAIB/N is therefore not really in agreement with the company that it should be of any significance that such factors were not discovered previously. The fact that the inspection authority had made few observations during previous inspections does not reduce the degree of seriousness of the inspection reports from 1997. If the safety authority had such serious comments on the technical division as the reports indicate, there is every reason to assume that these comments were representative of the situation at the time they were made. The conclusions in the reports must not necessarily be perceived as elements of a long-term trend, and obviously not as something that should persist. The AAIB/N can understand that the company feels that the report was too critical, because it felt that it had invested huge resources in safety work. However, there is reason to believe that such comprehensive reports from the inspection authority ought to be of great assistance in an internal process of improvement. One precondition for this is that the company should be willing to see that any critical comments from the safety authorities are made with the purpose of contributing to a process of improvement. This should also apply to other sources with a professional right to make statements on safety matters.
- 2.8.2.3 In addition, the AAIB/N believes that, viewed in isolation, the observations in the aforementioned reports do not directly concern safety in the company's operations, but on the other hand that there are symptoms of conduct that have to be improved, as the NCAA expresses it. The AAIB/N believes that it has learnt that the HS organisation possesses the competence that has to be present to ensure that the future quality improvement process takes into account the factors mentioned in the inspection authority's reports from 1997.

2.9 Maintenance performed in the company

2.9.1 Factors at the company's technical department believed to be disadvantageous by the AAIB/N

- 2.9.1.1 In conjunction with the investigations concerning the accident, the AAIB/N has identified 10 factors in the technical department at HS that the AAIB/N believes could be improved. These factors represent non-conformances with company's regulations or represent disadvantageous practice in some other way:
- 1 During the revision of the MRM, relevant maintenance requirements were made unclear (see subparagraph 1.18.1.2).
 - 2 The unfortunate consequence of the revision was not caught by the company's quality system (see subparagraph 1.18.1.2).

- 3 It is likely that the O-ring on the R/H splined sleeve was not installed during the execution of the last G-check (see subparagraph 1.6.6.4).
- 4 No O-ring was installed on the R/H splined sleeve on replacement of the Bendix shaft (see subparagraph 1.6.6.4).
- 5 The discovery of the missing O-ring and the subsequent installation of the Bendix shaft without a new O-ring being installed, was not warned of or entered as a non-conformance in the DMR (see subparagraph 1.6.6.4).
- 6 Main Task 72 was not used during the last inspection of the coupling between the Bendix shaft and the MGB (see subparagraph 1.6.6.6).
- 7 The O-ring was not removed and consequently not re-installed in conjunction with the performance of the last NDT inspection (see subparagraph 1.6.6.6).
- 8 There is no documentation to show that the splined flange was inspected in accordance with the MET in conjunction with the last inspection of the coupling between the Bendix shaft and the MGB (see subparagraph 1.6.6.6).
- 9 The HUMS accelerometer for the main gearbox R/H shaft input was out of service for a lengthy period prior to the accident (see subparagraph 1.6.4.6).
- 10 The PFC was not signed off in the helicopter's DMR prior to departure on the day of the accident (see subparagraph 1.1.2).

2.9.1.2 To assist during the analysis of these factors, the AAIB/N has used an analysis model developed by Professor J. Rasmussen. The model is part of a methodology developed to promote a greater understanding of the background to actions that entail some risk (unsafe acts). The method can be of assistance in discovering areas of investment where resources can be put in, and in that way prevent repetitions of unsafe acts. The model is illustrated below.

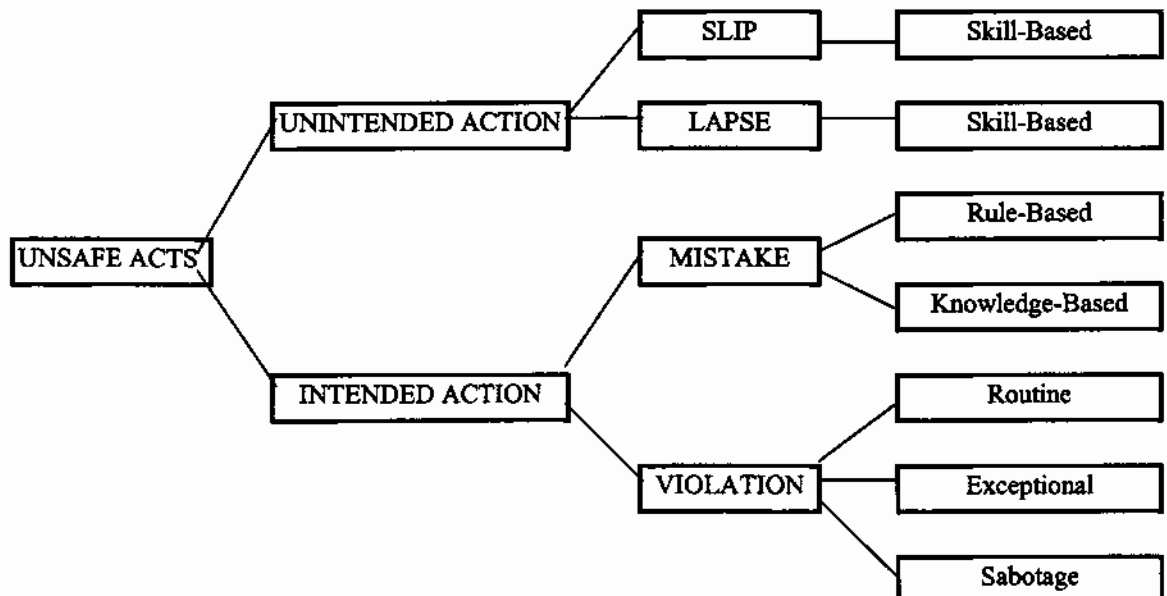

2.9.1.3 The AAIB/N's understanding of the expressions used in the Rasmussen model are as follows:

- Unsafe acts: Actions that entail risk
- Unintended action: An action that is unintentional or that is not meant

- Intended action: An action that is meant
- Slip: An error controlled by unconscious, instilled procedures or reflexes
- Lapse: An omission
- Mistake: An error
- Violation: A breach of procedures/regulations
- Skill-Based: Instilled procedures and accomplishments that can be carried out unconsciously
- Rule-Based: Action based on procedures that are learnt or described
- Knowledge-Based: Action based on knowledge and understanding
- Routine: Routine breach of the rules
- Exceptional: An isolated breach of the rules
- Sabotage: Malicious damage or destruction.

2.9.1.4 Traditionally, this model has been used for flight crews. As is made clear in the explanation above, the expression "skill-based" has been linked to proficiencies and reaction patterns that have been practised so that they can be carried out unconsciously or as reflex actions. Such skills are of central importance to flying crews, but have little relevance to maintenance work. In the opinion of the AAIB/N, the model allows little scope for "unintended actions" also being due to factors other than failure of reflex actions or practised automatic actions. The AAIB/N also considers that the interface between the expressions "unintended action" and "intended action" may depend on what is defined in the chain of events as "unsafe acts". Because there are few critical work operations at the technical department of a company that are based on imprinted unconscious patterns of reaction and reflex actions, it would be natural to link unsafe acts to intended action. In the analysis of each individual work operation (unsafe act), an attempt has been made to give a clear statement of the relevant expressions. On the basis of this the AAIB/N has arrived at the following:

- 1 The AAIB/N believes that the loss of clarity during the revision of the MRM was the result of an error (see subparagraph 1.18.1.2). The error arose during a revision that took place in the transition period between a maintenance system based on Work Cards (Main/Sub Tasks) and the introduction of a Work Pack System. In this process, most references to Main Tasks were removed and the work was mainly based on references to the helicopter's maintenance manual (MET). The information in "HS REVISION" that the "Main Task 72" can be found in the MRM (see subparagraph 1.6.6.6) cannot be said to be an unambiguous overall requirement to use the document. The AAIB/N believes that the introduction of the Work Pack System was not described satisfactorily in the company's technical manuals. Nor can the AAIB/N see that the consequences of this transition had been assessed by the company's technical management in a satisfactory manner. Those carrying out the revision did not discover, or did not realise, all of the consequences of omitting the reference to Main Task 72. A comparison of the requirements in the helicopter's maintenance programme (PRE) and the requirements, as they became, after the revision of MRS no. 14887 would have shown that order for the inspection was

unclear. The AAIB/N believes that this failure was able to occur because the routines for the introduction of the Work Pack System were deficient, and because no routines had been incorporated to ensure that the revised content corresponded to the original maintenance requirements. The error can therefore be characterised as *rule-based*. This shows that, particularly during introduction of new systems, strict requirements must be specified for analyses of consistency and unambiguous procedures.

- 2 PM-TD chapter 01-23 provides requirements for a review of the revisions made "by the section manager" if the revision is classified as "Major". The revision of the inspection of the R/H side (MRS no. 14887) was classified as "Minor". However, the revision of the inspection of the L/H side (MRS no. 14885) was classified as "Major". Also, during this revision, the consequences of omitting the reference to the Main Task were not fully understood. Because of the lack of available written documentation, the AAIB/N cannot clarify why the failure during the revision was not picked up either on the R/H or the L/H side. However, it can be established that the company's self-imposed quality assurance of the revisions did not pick up the error and therefore had not worked as intended. The section manager obtains a weekly summary of the revisions that are to be carried out. On the basis of the sometimes large number of revisions that have to be reviewed, and the limited background information that is presented for each revision, it would appear to be difficult to carry out a first-rate check. Based on the procedures and instilled routines which were to hand, there could be no expectation, consequently, of the error being detected. The AAIB/N believes that this failure in the control routines was *rule-based*. The company should therefore assess whether the control routines can be improved.
- 3 All available documentation indicates that the O-ring on the R/H splined sleeve should have been installed during the last G-check. There is no reason to doubt the information given by the aircraft technicians that the O-ring was missing when the R/H Bendix shaft was removed on 16 July 1997. The AAIB/N does not see that there would be any motivation for putting forward incorrect and, for the aircraft technicians, detrimental information about the O-ring. It also appears quite improbable that the O-ring would have been damaged in such a way as to fall off and disappear completely during this work. If the O-ring was missing on 16 June, there are only two options. Either it was not installed during the G-check or it disappeared during the period up to 16 June. There are no details of the R/H Bendix shaft having been disconnected from the MGB during this period. This therefore indicates that the O-ring was already missing during the installation during the G-check. The AAIB/N has no explanation as to why the O-ring was not installed, despite the fact that there are three signatures confirming that it was in place. Since this course of events is not known, it has not been possible to link this to the Rasmussen model.
- 4 Both of the aircraft technicians who carried out the replacement of the Bendix shaft were aware that the helicopter was prepared for flying without the O-ring. One of

the two believed that the O-ring was not supposed to be in place and this omission is a *knowledge-based* error. The frequency of such errors can be reduced by increased training. The AAIB/N believes that the company should assess whether training can be improved. In that context, there seems to be reasonable doubt as to whether the O-ring should be fitted, based on the information that was available for the technicians. It seems that the "rules" do not appear to be consistent since the helicopter's IPC and Main Task show that the O-ring must be fitted, but the specified reference document for the work (MET 63.10.00.401) does not mention the O-ring. Later that same day, the second technician contacted the company's technical department at Sola and had it confirmed that the O-ring should be in place. Before he left Brønnøysund, he informed the technical supervisor about this. At this time, it was clear that if the O-ring had not been fitted retrospectively it would be a *breach of the rules*. Breaches of procedures may be an indication that the procedures are difficult or impossible to implement, usually in combination with poor motivation or a lack of understanding of the importance of specific work. Breaches of procedures may also be an indication that the procedures are not being enforced unambiguously. The AAIB/N believes that the company must analyse this situation in more detail.

- 5 The discovery of the missing O-ring and the subsequent fitting of the Bendix shaft, without a new O-ring being installed, was not warned of or reported in any way. Neither did this take place after it had become clear that the O-ring was supposed to be installed. Those involved were not able to supply any explanation for why this was not done. A discrepancy like this must be entered in the DMR. It can be seen that this discrepancy is clearly connected with item 4 above and can be characterised as *an isolated breach of the rules*.
- 6 Main Task 72 was not used during the inspection of the coupling between the Bendix shaft and the MGB. The aircraft technicians involved chose not to use Main Task 72 and believed that there was no absolute requirement to use these, even if appropriate Main Tasks were available for the work. Neither can the AAIB/N see that there are unambiguous requirements for the use of Main Tasks in the case in question. Omitting to use Main Task 72 as maintenance instructions, in combination with errors in the text on the maintenance task ordered, led to inspections and results documentation being left out. The lack of such unambiguous requirements for using Main Tasks should therefore be characterised as a *rule-based* error. On this basis, the AAIB/N believes that the company must undertake a review and clarify the use of Main Tasks in the company.
- 7 In the manufacturer's maintenance instructions (MET 63.10.00.602, see Appendix A), which form the basis for the inspection that must be carried out, it is clearly stated that the O-ring must be removed before the NDT inspection is performed. The text of the order for the work states:

"Perform NDT of Right MGB Input Sleeve iaw MET 63.10.00.602, para. 3.4."

This could be understood in several ways:

- it might mean that only the NDT part of para. 3.4 should be carried out, and that the other items (e.g. remove seal) were not included
- it might mean that the whole of para. 3.4 should be carried out, including 3.4.1, 3.4.2, 3.4.2.1 and 3.4.2.2
- it might mean that only para. 3.4 with the two non-numbered items should be carried out (including remove seal).

This lack of a precise formulation may have been a contributory factor in the lack of attention given to the O-ring. The NDT technician has stated that he only adhered to the documents that were of importance to carrying out the specialist part of the work, namely the actual dye penetrant inspection. Consequently, it was that work that he signed off. In addition, he had less practical knowledge of reference document MET 63.10.00.602 because he did not adhere to it in his everyday work. In most cases, the NDT technician inspected the splined sleeves after they were removed from the helicopter and the O-ring was normally taken off then. During the inspection in question, none of those involved pointed out that the O-ring was missing. This indicates that there was no attempt made to remove or install the O-ring as described in the MET. The omission of these work operations has a complex background, in the opinion of the AAIB/N. The AAIB/N believes that the O-ring must be removed to simplify the cleaning of the splined sleeve in this area. This would also prevent NDT chemicals lying around the O-ring down in the groove. The fact that the NDT technician did not know of the existence of the O-ring indicates that little attention was usually devoted to this. In the opinion of the AAIB/N, a lack of attention to the existence of the O-ring could indicate problems in setting limits between work operations belonging to aircraft technicians and other specialist groups. There was no description of who had the responsibility of removing the O-ring, and the aforementioned ambiguous text in the maintenance instructions led to further opportunities for error. According to those involved, the inspection was carried out in accordance with established practice. The work was carried out in a way that those involved believed was correct and in accordance with company procedures. The fact that the items covered by the inspection nevertheless were left out can be linked to deficiencies in the routines. This discrepancy is characterised as a *rule-based* error. The AAIB/N believes that the company should check that the text in maintenance instructions can not be misunderstood or wrongly interpreted. In addition, the company should review the interface between different specialist groups where these have to execute and sign off various tasks of work within the same item in maintenance instructions.

- 8 The same loss of information in the MRM as that which affected the NDT inspection also led to it not being possible to document the fact that the splined flange was inspected according to the requirements in the PRE. The AAIB/N believes that this, in the same way as in item 7, was due to a *rule-based* error.
- 9 The AAIB/N believes that the HUMS accelerometer was out of service because there were no clear guidelines for the operation and maintenance of the system. The

system was dealt with deliberately (intended action) in accordance with the tradition that had developed in the company. The fact that the accelerometer for the R/H input pinion on the MGB was left out of service for a period of more than two months, can be characterised as a *rule-based* error. If this is not to be repeated, the company must draw up and implement new routines for the operation and maintenance of HUMS.

- 10 The lack of an entry for an executed PFC did not have any influence over the course of events. The AAIB/N believes that this was a pure oversight, but it might indicate that not enough emphasis is put on the company's procedures because the pilot-in-charge also did not question why there was no entry for the PFC. In this case, the natural thing would be to believe that signing off the PFC after it is performed, ought to be an absolutely automatic action for which the procedure was clear. The extent to which this oversight can be blamed on a lack of specialist skill might be a matter for discussion. However, it ought to be possible to establish that the aircraft technician did not have any practised courses of action nor had he taken precautions in his work that were sufficient to prevent the oversight. Consequently, the oversight could be said to be *skill-based*. To prevent any repeat, the aircraft technicians should think through what they could do differently so that interruptions or other influences do not lead to such oversights.

2.9.1.5 A review of these ten cases using the Rasmussen model shows that six of them can be characterised as rule-based. One of the cases can be characterised both as knowledge-based and as a breach of the rules. A further two cases can be characterised as a breach of the rules and skill-based, respectively. The remaining case cannot be placed in any group since the circumstances behind the failure are not known. Without stressing this analysis too much, this shows that there is a great predominance of factors in the company's technical department that can be linked to the procedures and routines described or to a lack of these. This corresponds with the observations made by the AAIB/N during its review of the company's technical quality system (see subparagraph 2.7). The AAIB/N believes that an appropriate quality system, with unambiguous internal procedures and routines, makes a good starting point for the maintenance work that has to be carried out. However, the AAIB/N would also like to draw attention to the overall working situations in which a piece of work is carried out. The section below illustrates some of the factors affecting the working situations of the aircraft technicians.

2.9.2 The working situations of the aircraft technicians - the human factor in maintenance

2.9.2.1 *Introduction*

For many years, flight safety work has focused on human factors on the aircraft operations side. This has led to a series of measures, including the introduction of a course in Crew Resource Management (CRM) and requirements for training in Human Performance and Limitations (HPL). In latter years, the term CRM has steadily acquired a broader meaning; for example the term has developed to apply to a whole

organisation - Company Resource Management. This is in recognition of the fact that the human individual, alone or with others, has an influence on virtually all factors of any significance in an organisational system such as management, culture, attitudes, procedures, development, training, maintenance etc.

The work on the aircraft operations side has produced positive results. However, latterly, a new and disturbing trend has been displayed; that is, that maintenance failures have been proven to be direct or contributory causal factors in aircraft accidents to a greater extent than before. In turn, this has led to a greater focus on the "human factor" within the field of aircraft maintenance as well. A widespread sector attitude has led, however, to the focus not having been so pronounced within aircraft maintenance as is currently familiar on the operational side. Internationally, the topic of human factors in aircraft maintenance has been being dealt with for several years. For example, in March 1998, the CAA held "The 12th Symposium on Human Factors in Aviation Maintenance" without this apparently having been known outside a limited environment. The AAIB/N believes that flight safety work is a cross-specialisation concern, to the very highest degree. Because of this, the significance of human factors on safety ought to be paid the same amount of attention in both the operational and technical communities, not least within the same organisation. Below is an analysis by the AAIB/N of some of the factors that have an effect on the work carried out in the department, with particular emphasis on the working situations of the aircraft technicians.

2.9.2.2 *Maintenance instructions*

The AAIB/N has reviewed, in detail, parts of the maintenance requirements that were applicable to LN-OPG. With the proviso that "everything gets easier once it has been learnt", the AAIB/N believes that the maintenance system, with all its details, seemed complex and impenetrable. This makes more difficult the general overview that aircraft technicians have to have of their work. Below, the AAIB/N indicates a number of factors that are relevant in this context:

- 1 ECF is not consistent in describing or naming parts of the helicopter. This results in it being possible for one and the same part to have up to four different names depending on where it is mentioned (Illustrated Parts Catalogue, Maintenance Manual, Service Bulletins, training books etc.). In the opinion of the AAIB/N, this is imprecise and could give rise to uncertainty and misunderstandings. The AAIB/N believes that ECF must choose one name for each part or component and then consistently use this. This must also apply even if the component has been manufactured by a subcontractor.
- 2 The maintenance system, as it has been described by ECF, contains many references and cross-references. To carry out even minor work, a series of documents may need to be procured. Then a decision has to be made as to which of the references are relevant. These references may in turn refer to a larger number of documents. This reduces the general overview. The AAIB/N is aware that the information that is given must be complete, and that it must be possible to adapt it to different working situations and to people with different backgrounds. However, there is a

risk that important information may be lost in what an experienced ICAO II aircraft technician would call obvious details, such as "install access equipment" and "open sliding cowling and engine cowling" when the engine has to be removed (see Appendix B, item 3). Maintenance instructions, which contain a large amount of "irrelevant" information, increase the chance of relevant information not being taken seriously. This problem does not just apply to maintenance instructions, but also to manuals and other literature. In its "Administrative & Guidance Material" for the performance of inspection activities, the JAA has stressed that so-called "superfluous" text should be removed from the operators' manuals. At the same time, the JAA states that such text may be directly detrimental, because it has a tendency to shield from view the information that staff *must have, must understand and must comply with*. It is therefore a challenge to those who produce the maintenance instructions to understand how the basic data must be formulated in order to be best adapted for the users.

The AAIB/N believes that ECF must carry out a thorough review of the documents in the maintenance system which currently apply to the AS 332L1, with a view to making them more user-oriented. Emphasis should be placed on improving the general overview for the specialist groups that have to carry out work on the helicopter. In particular, stress should be put on reducing the number of references by gathering together the relevant information and using clear, unambiguous language.

- 3 Installation of the engines must be carried out in accordance with MET 71.00.00.401. Installation of the relevant O-ring (MS9388-133) is not mentioned in this procedure (see Appendix B). The AAIB/N believes that this procedure would have been the obvious place to mention the O-ring, since it has to be installed before the engine is fitted. Installation of the O-ring is only discussed in conjunction with work on the MGB and in MET 63.10.00.602. MET 63.10.00.602, which deals with the inspection of the coupling, is just given as a reference document for MET 71.10.00.401. The AAIB/N believes that this is an example of it being unnecessarily difficult to find relevant information in the maintenance instructions developed by ECF.
- 4 As a user, HS has developed its own maintenance system for AS 332 helicopters based on the requirements from ECF, Turbomeca, the French and Norwegian Civil Aviation regulations plus its own practical experience. This means that, in many cases, HS is adding its own requirements to the maintenance requirements specified by ECF. This leads to the use of references and introduces opportunities for error. The AAIB/N considers it to be an almost impossible task to coordinate the maintenance systems from several helicopter manufacturers into a joint system in the company without this leading to compromises and detrimental solutions. However, HS should work more intensively to make the maintenance system plus associated work instructions easier to understand, more precise and more relevant.

- 5 The text that was used in ordering the inspection of the coupling between the Bendix shaft and the MGB was changed eight times, either in content or in its presentation format, during the period from when the helicopter was taken over from Mørefly in 1995, up to the accident. This provided a lot of opportunities for the introduction of errors. In addition, it may have led to it becoming more difficult for aircraft technicians to recognise the presentation format, and therefore to detect changes in the inspections.

2.9.2.3 *The technical division's documented quality system - training and standardisation*

The function of an aircraft technician is regulated by a series of regulations, provisions and procedures established by the aviation authorities and the company. Becoming familiar with, adhering to and then keeping up-to-date with these can be a demanding task. In general, it could be said that the company sets relevant and fairly strict requirements for the skills levels of aircraft technicians as regards understanding of the company's system of documents. In particular, this applies to the technical quality system (the MOM and PMs), but also to the Norwegian and overseas aviation authority regulations. A question mark might be set against just how well thought through these requirements are and, not least, how they are organised in practice. First, aircraft technicians must be trained in the company's quality system. When they work as maintenance personnel, they have to adhere to the quality system of the technical department, in which they ought to be given training. When they become "certifying staff", they are given training in the company's organisation and documentation systems, civil aviation law and civil aviation regulations - this is training which might be considered to be part of the basic training of an aircraft technician. In addition, "certifying staff" have to personally familiarise themselves thoroughly with the technical quality system, which is principally the MOM and PMs, and a series of relevant overseas regulations/provisions.

Internal training in the company has been set several challenging tests with regard to training and standardisation. HS has acquired several helicopter companies. This has meant that the company took over aircraft technicians with certificates on the AS 332 Super Puma from the merged companies. The obvious assumption would be that these would be very familiar with this type of helicopter, but that they would be less familiar with the company's internal routines and maintenance systems. This situation requires re-training to allow adaptation to the company's routines.

Before the accident, HS made considerable alterations to its maintenance system and its in-house procedures. This set a challenge for the maintenance personnel and in particular for those maintenance personnel who came from the merged companies. If ambiguities were to arise in a situation like this, the routines that were learnt first, and which would generally have been used over a long period of time, could easily dominate routines learnt later. Employees who have been merged into the company must therefore, in addition to learning new routines, actively try to forget the old ones – also described as learning and unlearning.

Some of the observations that the AAIB/N has made indicate that the company has not completely succeeded in this. For example, during conversations that the AAIB/N had with the staff concerned at several levels, it appeared as though some fundamental insight into the structure of the system of manuals was missing. The practical knowledge of relevant procedures and routines seems to have been significantly better, however.

In a company where the manual system is built up in three levels, as at HS, it is of decisive importance that all relevant categories of personnel have the requisite understanding of the buildup of, knowledge about and usage of the manual system. The system of manuals must not be purely used for self-instruction, but must also be a reference work in day-to-day working. This means that there must be a good balance between the basic training that the company provides, the self-instruction that is needed and the follow-up that ensures continuity in the level of knowledge. Such balance requires, among other things, that the manual system is readily available and updated. Based on the comments of the AAIB/N in chapter 2.7 concerning the system of manuals, it is the opinion of the Board that the technicians are not provided with the best basis for use of the system of manuals for self-instruction and as a source of reference. This is one of the reasons that the AAIB/N is of the opinion that more priority should be given to the ongoing work on the technical manuals than is the case, if the “accuracy and integrity” that the AAIB/N searches for is to be achieved.

On the basis of this accident, HS ought to assess how the technical documentation system could be improved, and the extent to which education and training in this documentation system could also be improved.

2.9.2.4 *The base in Brønnøysund*

Several of the discrepancies mentioned in subparagraph 2.9.1.4 took place in Brønnøysund. After a lengthy period when little activity was linked to the base, activity increased considerably during the summer of 1997. The base was therefore subject to a form of re-establishment while also serving a lot of helicopter traffic. The AAIB/N does not consider it possible directly to link the non-conformances mentioned to this re-establishment. In general, however, problems can arise more easily at bases that do not possess all of the resources that are available to the company's main base. The AAIB/N assumes that the O-ring would have been fitted in connection with the Bendix shaft replacement if this had been in store at Brønnøysund or if the planning of the work had led to an O-ring having been sent to the base together with the shaft. As the situation was, the technicians were faced with two acceptable alternatives. Either the work could be stopped until a new O-ring arrived at the base, with the subsequent cancellation of the flight, or the duty personnel in the technical department at Sola could have been asked for possible dispensation to fly without the O-ring for a limited period. The latter alternative would consequently have led to considerably more work, with an extra removal/installation of the R/H engine at a later date.

2.9.2.5 *Available time*

As far as the AAIB/N knows, sufficient time was assigned to the maintenance work in question on LN-OPG, assuming that no problems arose. When it became clear that

there was no O-ring, the AAIB/N assumes that the remaining time until the morning's planned departure could have been a contributory factor in the O-ring not being installed.

2.9.2.6 *Night working*

Research shows that human performance is normally lower at night than during the day. The chances of making a mistake or making wrong decisions are therefore greatest at night. Both the replacement of the Bendix shaft and the inspection of the coupling between the Bendix shaft and the MGB took place at night. However, the AAIB/N does not have any grounds to indicate that these work operations would have been carried out in another way under otherwise similar circumstances during the day.

2.9.2.7 *Conclusion*

In this investigation, the irregularities that have been discovered at the technical department at HS can, in a positive sense, indicate areas for improvement within the department. In that context, the AAIB/N believes that the aircraft technicians and their working situations are central to maintaining high standards of flight safety. This applies, in particular, to work on helicopters, which contain many safety-related technical solutions. The AAIB/N has been made aware that, after the accident, the company has implemented a project to direct focus on the human factors in aircraft maintenance. The AAIB/N believes that this work is very positive and should be continued. It is a management responsibility that this job category is also given the fewest possible opportunities to make errors. The AAIB/N believes that it is important that the management integrates the expertise that exists within "Human Factors in Aviation Maintenance" and uses this in the flight safety work within the organisation.

2.9.3 The NDT method - dye penetrant

The AAIB/N considers that MRV 63.28.10.835 provides a better basis for carrying out a dye penetrant inspection of the splined sleeve than the prescribed WC 20.02.09.101. At the same time, HS believes that it has used the prescribed NDT method and associated chemicals in this way. The selected method (level E3) makes it possible to detect very small cracks on smooth surfaces. The splined sleeve has been sprayed with tungsten carbide. No form of mechanical treatment is carried out after spraying (only light brushing) and the component therefore has a fairly rough surface. This type of surface may be difficult for an NDT operator to handle because the penetrant may be difficult to clean away, or because a more thorough cleaning may remove the penetrant from the crack as well. It is very likely that the problem to detect 26 micro cracks in a splined sleeve (see subparagraph 1.16.4.7) experienced by HS illustrates this problem. Despite this, level E3 dye penetrant is regarded as being the most suited amongst the penetrant methods for field use.

The dye penetrant method is limited to detection of cracks on the surface. A crack that initiates and grows underneath the hardmetal coating will not be detected. However, there are reasons to believe that cracks in the relatively ductile base material soon will lead to cracking in the more brittle hardmetal coating. Despite the mentioned

limitations, AAIB/N is of the opinion that the utilised dye penetrant method is suitable to detect cracks on the surface of the splined sleeve. For optimum crack detection of separate splined sleeves however, Magnetical Particle Inspection (MPI) seems better suited. A MPI is not effective on the cylindrical areas (100 µm thick non-magnetic coating) and these areas must be inspected by other means.

The AAIB/N believes that the described NDT-method has weaknesses and limitations in its capability to detect small cracks in the surface coating. Therefore ECF must evaluate if the routines for NDT-inspection of the splined sleeve can be improved. AAIB/N has been unsuccessful in establishing to what extent another method of NDT-inspection could have detected cracks in the splined sleeve during the inspection 22 August.

2.9.4 The overhaul of main gearboxes

HS has experienced having had a gear accepted by the company during an overhaul, only to be assessed by ECF a short time later as being worn to an extent outside the manufacturer's tolerances. This was confirmed when the R/H 8 000 RPM wheel from LN-OPG was found by ECF to be outside the tolerances. When the part was later examined by HS, it was possible to approve it for further use on the basis of the requirements stated in the MRV (only with regard to wear on the teeth). The control method described therefore seems to be of little value with regard to the kind of wear demonstrated. The wear on the teeth of the 8 000 RPM wheel has proven to be a central theme in connection with the vibrations in the MGB. The AAIB/N is therefore of the opinion that ECF must re-assess the overhaul criteria given in the MRV so that gears, which are outside acceptable values with regard to wear on the teeth, will be detected in time.

2.10 HUMS

2.10.1 HUMS was developed and brought into operation after there had been a number of serious technically-related helicopter accidents in the North Sea over a period of several years (see subparagraph 1.6.4.2). The motivation for installing HUMS was to increase safety, and the AAIB/N assumes that there was no reason other than the desire to increase safety that led to the Norwegian Civil Aviation Authority approving the installation of the system. However, the AAIB/N believes that, after approving the system, the attitude the NCAA took to HUMS was too passive. This passive attitude has, in the opinion of the AAIB/N, contributed to the system not being given necessary priority at HS. In that context, the AAIB/N believes that it is important to look at the outline conditions under which the system operates. The framework that the NCAA set up around HUMS focused principally on the system having no effect on the helicopter's airworthiness (No Hazard). Otherwise, the only requirement specified for the system was that it had to be maintained in accordance with the manufacturer's requirements.

2.10.2 The AAIB/N believes that the obvious thing would have been for the NCAA to be more involved with regard to a safety element such as HUMS. Passenger transportation by helicopter in the North and Norwegian Seas is very widespread. An independent report

(SINTEF "Helicopter Safety Study", issued in 1990) establishes that this form of transport involves considerably higher risks than commercial scheduled airline operations. The same report points out that HUMS ought to be an area for major investment in order to increase technical reliability. In this context, by far most of the accidents and the incidents on the Norwegian side can be traced back to technical problems. Because HUMS was intended to be a tool for reducing the possibility of accidents occurring due to technical failure, thereby increasing safety during the helicopter transportation of passengers, the AAIB/N believes that the obvious thing would have been for the NCAA to focus on several areas of investment, such as:

- to seek to establish a set of joint regulations for HUMS in collaboration with the aviation authorities from the countries around the North Sea basin and the sea areas in the north
- together with the same aviation authorities, in the capacity of inspection authorities for a considerable part of the total amount of passenger transportation by helicopter within Europe, to work to ensure that safety is taken care of, in that context, in the best manner possible by the JAA with its associated regulations (JAR)
- to monitor helicopter companies closely with regard to utilising the system's potential, using methods such as periodic evaluation
- to specify requirements for the system's serviceability by means of the MEL, for example
- to be a catalyst in the exchange of experience between various operators and equipment suppliers.

2.10.3 The AAIB/N has gained an insight into the company's situation with regard to HUMS. The introduction of a system that should have led to increased safety made great demands on resources, but the result was not as expected. This led to an active project to establish the best possible system, gradually converting into a form of resignation and passivity. The AAIB/N believes that this was a contributory cause of LN-OPG flying for long periods with important parts of the system, or the entire system, out of service. This was possible because the company had not specified any requirements for serviceability, nor was it an aviation authority requirement. Neither did the company have any procedure for daily reviews of information from the HUMS Log Report. Altogether, this led to the system being able to detect problems in the helicopter to only a very small degree, before they were perceived by some other means.

2.10.4 Based on a collective impression, the AAIB/N believes that the company did not have any strategy, quality plan or any clear objective for the way in which HUMS should be looked after within the company. The lack of focus directed towards HUMS was not a conscious decision. In the opinion of the AAIB/N, the status of HUMS at the time of the accident was the result of random development and not a conscious choice. This factor was not taken sufficiently seriously by the company's management.

- 2.10.5 The AAIB/N believes that the company ought to have overall responsibility for safety in the flight operations they carry out, independent of any lack of detailed specifications and safety requirements of the aviation authority or customer. After the accident, the company introduced a number of good measures with regard to exploiting the safety potential of HUMS. In this respect, the self-imposed requirement for serviceability is essential.
- 2.10.6 In comparison with most other types of civil aviation, the customers (the oil companies) play a central role in conjunction with oil-related flights. The customer sets many of the central terms for the flights; for example, destinations, frequency and requirements for the helicopter, in addition to being the helideck operators. This means that the company and the customer have to collaborate closely in a number of areas. One consequence of this is that, for a number of years, the customers have carried out comprehensive audits of the helicopter companies to ensure that these maintain an expected standard. The AAIB/N has noted that the deficient serviceability of HUMS has not been a factor in the relationship between HS and the customers. With one exception, the oil companies have not contractually established that HUMS must be serviceable. The AAIB/N does not wish to assume any position on the extent to which the customer could expect HUMS to be maintained to the same standards as the rest of the helicopter. Even if the customers have not held formal responsibility in this area, there is reason to point out that they have traditionally been important in setting terms and conditions, and that, together, the customers have the opportunity of influencing the future use of HUMS.
- 2.10.7 The investigation has shown that IHUMS, installed in helicopters belonging to HS, obtained poor product support from both the suppliers of IHUMS and the helicopter manufacturer. In combination with the lack of finance for the further development of the system, this contributed to making it more difficult to realise the system's potential. Thus it was among others not set any limit value on the power turbine accelerometer. The rise in the standard of HUMS that has taken place after the accident has only been possible because the entire industry has been working to improve the system. This has been of considerable benefit to safety. The AAIB/N believes that further improvements can be achieved if the industry sets a standard for performance and functionality. In addition, the greatest potential for development lies in systems that form an integral part of the helicopter or where the system manufacturer works in close collaboration with the helicopter manufacturer.
- 2.10.8 Subparagraphs 2.10.1 to 2.10.7 have been written in the light of the fact that the accident could have been prevented if the trend in vibration development had been recognised in time. In this context, a serviceable accelerometer near the shaft input could have played an important role. The report highlights conditions that show that IHUMS, as it was installed on LN-OPG, had not had sufficient attention devoted to it from the safety authority, the helicopter manufacturer, the equipment supplier or the helicopter operator. The AAIB/N believes that this accident has shown that HUMS is capable of being an important tool in accident prevention, but that the system must be given clearer prioritisation by all of the parties involved if its safety potential is to be exploited.

2.11 Tie-bolt fracture

Representatives of ECF have stated that, from experience, a tie-bolt fracture can be an indicator of abnormal loadings in the drive train between the engines and the MGB, and that the fracture of the bolt in question most probably indicated that there was something wrong with the shaft coupling at this time (see subparagraph 1.6.6.5). The company has had a series of fractures in tie-bolts. Some of these had, most probably, been caused by the tightening torque applied to this "new" type of bolt being too high. The examinations undertaken at DNV have shown that the bolt from LN-OPG had a production fault in the threaded section and that the fracture started there (see subparagraph 1.16.4.5). Even though this has been disputed by ECF, the AAIB/N believes that the bolt fracture was, most probably, an isolated separate fault. The inspection of the coupling between the Bendix shaft and the MGB, which was performed 134 flying hours (19 days) after the fracture of the tie-bolt, did not detect that anything was wrong. This must either be due to the fact that there was no fault in the drive train at this time, or that the maintenance work did not detect a potential fault. If the bolt fracture occurred as a consequence of a fault in the drive train, the obvious thing would have been for a new bolt fracture to have occurred during the 121 hours that were flown after the inspection and, thus, in a period when a fault was certainly developing. On this basis, the AAIB/N considers it hardly probable that the bolt fracture in itself was an indicator of an incipient fault in the MGB or in the drive train from the engine.

2.12 Certification requirements

2.12.1 Certification requirements applicable to LN-OPG

The AAIB/N has found several weaknesses in the certification requirements applicable to LN-OPG. For the engine installation, it is specifically mentioned that there was no need to consider "engine rotor failure". In addition, some non-specific formulations such as "reasonable assurance" were used. Please refer to subparagraphs 2.3.3 and 2.3.4 where some of the requirements have been analysed.

2.12.2 Certification requirements valid as at January 2000

The AAIB/N believes that it is important to carry out an assessment of whether the applicable certification requirements deal with the risk factors that were detected in the accident involving LN-OPG. The AAIB/N finds that the requirements that are valid as at January 2000 are adequate in this respect. In the requirements that apply to engine installations, it is stressed that damage and faults in an engine must not affect other engines or systems. In addition, the requirements are generally made stricter when applied to the use of risk analysis as a tool to prevent unsuitable designs from a safety perspective. The accident has very clearly shown how vulnerable a helicopter can be to technical failure. In addition, it has shown that a long series of inept technical solutions, which may appear non-critical if viewed in isolation, in combination can lead to a fatal accident. However, the AAIB/N is of the opinion that the certification of new models of helicopter in accordance with current requirements, must be reviewed very

critically with regard to the documentation of risk assessments and calculations. In addition, the AAIB/N believes that JAA/FAA ought to assess whether, in addition to general requirements, specific requirements should also be set for the protection of vital flight controls in future helicopter designs.

2.13 Fire

The main gearbox was ripped off when the helicopter was on its way down towards the surface of the sea, together with the engine sliding cowling, R/H and L/H Bendix shafts and the power turbines with exhaust pipes from both engines. At this time, the gas generator belonging to the L/H engine was running at high speed. This led to heat damage occurring to the L/H engine cowling and to components mounted up on the cabin roof behind the engine. Since there were few flammable materials in the area, the AAIB/N believes that "the fire" was sustained only by the fact that the gas generator was running. The heat damage was therefore a result of the accident and was not a causal factor.

2.14 Survival aspects

2.14.1 Introduction

The autopsy reports have revealed that no one could have survived this accident. Observations concerning emergency equipment and the search operation are therefore of a more general nature.

2.14.2 Opportunities for survival in a controlled emergency landing

The AAIB/N believes that it would have been possible to carry out a controlled emergency landing on the sea if the control rods for the rotors had not been cut. A Super Puma, LN-OBP, that made a controlled emergency landing in the North Sea, in January 1996, remained afloat for several hours in wave and wind conditions that were comparable to the conditions on the occasion of this accident. Theoretically, if the helicopter had managed to make an emergency landing on the sea, there is reason to believe that it would have been located relatively quickly. During the period up to location and rescue, the passengers' safety would, to a great extent, have been dependent on the leadership and experience of the crew. With the clothing worn at the time, the crew would most probably have been put out of action before the passengers due to hypothermia. The AAIB/N considers this to be rather unsatisfactory.

The AAIB/N was critical of the crew's clothing at the time of the accident involving LN-OBP in 1996. This was discussed in the report from the AAIB/N (RAP 02/98 – English version exists). However, the AAIB/N issued no recommendations about this situation because at that time the company was working to resolve the problems linked with the crew's clothing and because new regulations were expected in JAR-OPS 3. The regulations contained in JAR-OPS 3 had not been implemented at the time of the accident involving LN-OPG. After this, the NCAA delayed further any implementation

of JAR-OPS 3 until 1 April 2001. The AAIB/N believes that the crew's clothing is so important that the situation has to be clarified without further delay. In this case, the crew lacked both survival suits and other protection against hypothermia. The AAIB/N believes that HS must speed up the work on requirements for crew clothing. This must apply to a collective assessment of both survival suits and the clothes being worn underneath. In this work, attention should be directed towards JAR-OPS 3, Section 2, Subpart D and K.

2.14.3 Emergency Locator Transmitter

The Emergency Locator Transmitter that was installed in LN-OPG did not contribute to locating the helicopter wreckage. This was due to it being destroyed when the helicopter hit the surface of the sea. In the opinion of the AAIB/N, the Emergency Locator Transmitter in question is vulnerable to loadings in conjunction with accidents and is positioned in a confined area that means that even minor damage might prevent it from releasing. An assessment should therefore be made as to whether it is suitable for its purpose.

2.14.4 The search operation

- 2.14.4.1 The course of events that has been found as a result of the investigation supports the assumption that no one could have survived this accident. Consequently, in hindsight, it is possible to state that the search operation was not relevant to the saving of lives.
- 2.14.4.2 The investigation has shown that the crew followed route TANGO to TANGO 90 and then flew straight towards the Norne (see subparagraph 1.15.3). The discrepancy that was found during the reconstruction of the helicopter's route may be due to inaccuracies in the helicopter's navigation equipment, different chart references, inaccuracies in data recorded by the FDR and margins of error in the route of the reconstruction.
- 2.14.4.3 Questions have been raised regarding whether it was right to establish the first search area based on a direct helicopter route from HELIK to the Norne, in preference to basing it on the fact that the helicopter had flown route TANGO to TANGO 90 and from there to the Norne as indicated in the flight plan. At a time when little information was available, the rescue management had to make this type of assessment. The information that it was possible, from the image on the radar screen, that the helicopter had flown the direct route to the Norne, was so essential that great importance had to be attached to it. As early as this in an operation, the objective would be to try to find what was being searched for with resources directed towards the most probable area. However, it is almost equally important to eliminate, as early as possible, any other possibilities, so that the search area can be limited. In the opinion of the Board, the rescue management at HRS-N would have been exposed to massive criticism if the information about the apparent radar route had not been taken seriously and if it had later been shown that the helicopter had crashed at a location along the direct route. Since the rescue management was initially using the F-16 in the sector that took in the route TANGO 90 to the Norne, and then increased the possibility of detection by sending the Jet Falcon to the same area, the Board did not

find any reason to add further comments concerning the rescue management's assessments and deployments at this time.

- 2.14.4.4 The further use of resources showed that they were used sensibly, and it did not take long before the Sea King helicopter from Bodø located the first pieces of wreckage. From that time on, it was quite clear that the search areas would have to be appropriate for searching for small objects floating low in the water. The work that was performed provided a very good starting point for locating the wreckage on the seabed when Rockwater 1 took over as OSC.
- 2.14.4.5 The helicopter was flying in uncontrolled airspace. The Bodø ATCC used radar primarily for providing information about air traffic in the area (Flight Information). In the opinion of the AAIB/N, the radar was not used to the optimum effect as a resource in connection with the search and rescue work. During the period after the accident, this has been improved significantly because it is now possible to place Helicopter Routes on to the radar screen as required, and because the last radar contact with an aircraft is automatically saved at all times. The use of M-ADS (Modified Automatic Dependent Surveillance System) has further improved the situation in connection with emergency situations and position determination for helicopters. Apart from this, however, the AAIB/N believes that all radar information from the air traffic control service should be saved and made immediately available to the Norwegian Rescue Services Headquarters in the event of accidents and search operations. This could contribute to delimiting a relevant search area at an early stage. A lack of access to relevant radar data was also discussed in the AAIB/N report no. 02/97 involving OY-BDY.
- 2.14.4.6 Helicopter routes were established primarily to increase levels of safety and clarity in uncontrolled airspace with high volumes of helicopter activity. The AAIB/N has noted that there are different opinions as to the amount of deviation there is from these routes, and the extent to which the air traffic control service is notified of these deviations. The AAIB/N has not carried out its own investigations concerning this, but believes this issue to be of major importance as a matter of principle. The Board therefore believes that the helicopter operators and the air traffic control service should jointly work out a practical arrangement that does not allow any room for misunderstanding.

3 CONCLUSION

3.1 Results from the investigation

3.1.1 General

- a) The flight was scheduled and was following an IFR flight plan.
- b) The flight was carried out mainly in IMC.

- c) With the exception of a few minor deviations, the helicopter followed a route leading from Brønnøysund via HELIK to TANGO 90 before flying straight to the oil production vessel Norne, as planned.
- d) The helicopter had been flying for 56 mins. and 30 secs., and was at an altitude of 1 830 ft when the R/H Bendix shaft failed.
- e) The crew discovered that something was wrong with the helicopter 6 mins. and 30 secs. before the accident. The fact that this was a serious problem was understood only seconds before the Bendix shaft failed. At this time, the crew did not have sufficient indications or time to take any necessary action to prevent the accident.
- f) There were normal communications between the crew, the air traffic control service and the Transocean Prospect during the flight. The crew did not transmit any form of emergency message during the flight.
- g) The crew had the necessary licences and had received the mandatory training courses.
- h) The crew's work and rest times before the accident were within the given limits.
- i) Neither of the crewmembers had any medical condition of significance to this accident.
- j) The weather conditions at the accident site were as follow: Wind 240° 24 kt. Visibility: 10 km. Clouds: Broken cloud cover at 1 000 ft. Temperature/dew point: Approx. 12 °C/9 °C. QNH 985 hPa. The weather conditions had no effect on the accident.
- k) After the accident, an estimated 90% of the helicopter wreckage was raised from a depth of 380 m. The investigation was not limited owing to missing relevant parts.

3.1.2 The aircraft

- a) Eurocopter AS 332L1 Super Puma was type certified on 14 March 1985 in compliance with FAR 29, revisions 1 to 16.
- b) The AAIB/N believes that modern principles of risk assessment/safety analysis, used in conjunction with the certification requirements for the engine, could have detected weaknesses in the shaft design, the systems for RPM regulation and RPM limitation. Otherwise, the helicopter was constructed in accordance with the applicable certification requirements.
- c) ECF chose to surface coat the splined sleeve based on experiences from completely different components used on other helicopters. It is the opinion of the AAIB/N that there is no comparison between these components and that the choice of coating is therefore not necessarily ideal.
- d) The helicopter had valid registration, environmental and airworthiness certificates.
- e) The helicopter's mass and the location of its centre of gravity were within the permitted limits.

- f) With the exception of the remark about the accelerometer close to the R/H shaft input, at the time of the accident the helicopter's technical logbook had no open entries of significance to the course of events.
- g) The helicopter was equipped with Integrated Health and Usage Monitoring System (IHUMS).
- h) HUMS, as it was installed in LN-OPG, was still under development, particularly with regard to software and application. The safety potential of the system was therefore not realised.
- i) IHUMS information from several of the company's helicopters was analysed after the accident. This showed that LN-OPG had a gearbox with a vibration pattern which was different, in significant respects, from what might have been expected on the basis of past experience.
- j) There had been a series of problems with the shaft coupling between the engine and the main gearbox (MGB) on this helicopter type. This had led to several improvements by and directives from the manufacturer.
- k) LN-OMG, a helicopter belonging to HS, had experienced an incident in October 1985 that was very similar to what happened with LN-OPG. This time, however, the lock washer did not enter into the Bendix shaft and the helicopter landed safely on one engine. As far as the AAIB/N is aware, this incident did not lead to the safety risks of the system being detected.
- l) The OVSP light was located in such a position that it could be difficult to detect and to differentiate it from other information lights in the cockpit.
- m) The helicopter's flight and voice recorder provided valuable details about the accident.

3.1.3 Maintenance

- a) The helicopter was maintained on the basis of a maintenance system approved by the Norwegian Civil Aviation Authority.
- b) The helicopter's IHUMS was maintained in accordance with existing aviation authority requirements.
- c) At the time of the accident, the company had no procedures for reading the HUMS Log Report on a daily basis.
- d) The splined sleeve and the splined flange were not individually numbered and were not maintained according to flight time.
- e) The maintenance instructions, MET 63.10.00.602, make it mandatory to perform a dye penetrant inspection on the splined sleeve. Otherwise, the document does not contain any requirements for thorough inspection of the splines on the splined sleeve or splined flange for wear or other damage.
- f) The AAIB/N believes that the described NDT-method may have weaknesses and limitations in its capability to detect small cracks in the surface coating.
- g) In their work, the company's aircraft technicians had to adhere to maintenance instructions, which could seem impenetrable in some areas and be the cause of errors.

- h) Eurocopter France (ECF) has not been consistent in describing or assigning names to parts of the helicopter. Because of this, the same part may have several different names depending on where it is mentioned.
- i) The maintenance instructions for inspecting the coupling between the Bendix shaft and the MGB were reworked a number of times. One of these changes led to maintenance requirements being left out inadvertently. As a consequence, Main Task 72 was not used in the last inspection of the coupling between the Bendix shaft and the MGB. This contributed to parts of the inspection not being carried out and that the work that was carried out was not documented.
- j) The AAIB/N cannot see that the company has any explicit requirement regarding the use of Main Tasks in conjunction with maintenance tasks where such exist.
- k) The helicopter's MGB (no. M170) was overhauled by HS in accordance with the factory's overhaul instructions (MRV), 613 flying hours prior to the accident.
- l) The inspection requirements with regard to wear on teeth on the 8 000 RPM wheel, as stated in the MRV, are insufficient to weed out examples that subsequently prove to be the cause of undesired vibrations in the MGB.
- m) The helicopter underwent a G-check during the period January to May 1997, in which the MGB (no. M170) and the R/H engine were replaced.
- n) The R/H Bendix shaft was replaced in July 1997. During this work, it was discovered that an O-ring on the R/H splined sleeve was missing. No new O-ring was fitted, however, and the discrepancy was not notified or reported.
- o) The fact that the R/H splined sleeve did not have an O-ring was not found during the inspection of the coupling between the Bendix shaft and the MGB on 22 August in 1997.
- p) By adhering to the described inspection, the aircraft technicians carrying out the Pre Flight Check (PFC) on the morning of the day of the accident had no opportunity to detect the failure in the drive train.
- q) The PFC was not signed off in the helicopter's Daily Maintenance Record (DMR) prior to departure on the day of the accident. This was of no significance to the course of events.
- r) Based on the Rasmussen model, a review of pointed out cases at the technical department, has shown that there is an overweight of cases connected to missing or wrong procedures.
- s) The AAIB/N has no grounds for believing that working at night or pressure of time have been factors of significance to the discrepancies that arose during maintenance work within the company.

3.1.4 Technical examinations

- a) It has not been possible to determine with certainty why the R/H splined sleeve on LN-OPG began to crack.
- b) The splined sleeve began to crack in the lower area of the active teeth surfaces on teeth nos. 6, 7, 14 and 15. Each of the cracks had one or more initiation points.

- c) The first cracks in the splined sleeve appeared in an area with high loads and demonstrated high wear
- d) All of the cracks in the splined sleeve arose as a result of fatigue, and they propagated at almost constant speed.
- e) It seems to be no traceable direct connection between cracks in the hard metal coating and cracks in the base material.
- f) The splined flange began to crack on 31 August 1997, approx. 62 flying hours before the accident.
- g) The splined sleeve began to crack before the splined flange.
- h) The hardmetal coating on the splined sleeve contained grains of tungsten carbide of a size equivalent to or greater than the thickness of the coating.
- i) An analysis of the coating that was found on the splined flange shows that its principal constituents were iron (Fe) and tungsten (W). Together with the lubricating agent, it is probable that this formed an abrasive paste that contributed to the breakdown of the hardmetal coating on the splined sleeve.
- j) There are no findings to indicate that the cracks in the splined sleeve arose as a result of deficient lubrication.
- k) The front suspension bar of the main gearbox failed due to overload. This happened as a result of the accident.
- l) No damage has been found on the bearings in the MGB that could have had any significance to the course of events, and no abnormal deposits were discovered on the magnetic plugs in the gearbox oil system.
- m) The investigation has not discovered any operational factor that would be capable of leading to extreme or abnormal loadings on the drive train between the engines and the main rotor.
- n) The incident lasted 2.3 secs., from the time when the Bendix shaft failed, until the engines were destroyed and the control rods were cut.
- o) The L/H gas generator section was operating right until the helicopter reached the surface of the sea. This explains why heat damage occurred behind the engine.
- p) The main rotor blade, which was found floating almost undamaged a short time after the accident, separated from the rotorhead as consequential damage.
- q) A fractured tie-bolt, which was discovered on 3 August 1997, cannot be linked to the accident.

3.1.5 Organisation and management

- a) The AAIB/N believes that the appropriateness of the company's technical quality system could be improved with a view to achieving a good quality culture and ongoing quality improvement.
- b) The documented quality system at technical division contains errors and flaws that mar an otherwise structured system.
- c) In two reports, the NCAA has expressed some severe criticism of the company in connection with its technical department inspections in 1997.

- d) Several employees with whom the AAIB/N held conversations were not very familiar with the content of the company's technical quality documentation.
- e) Before the accident, HS carried out considerable changes to its maintenance system and its internal procedures. This may have led to there being some doubt about which procedures were applicable.
- f) The AAIB/N believes that an increased focus on Human Factors in Aviation Maintenance can improve the working situation for technical personnel within the company.
- g) The maintenance instructions that were used on LN-OPG had been approved by the NCAA.
- h) During inspections, the NCAA appears to have put little emphasis on a critical evaluation of the company's control documentation.
- i) During its inspections, the NCAA did not carry out a combined and overall assessment of the quality system in the company's technical and operations departments.

3.1.6 Survival potential

- a) The helicopter was outside radar cover when the accident occurred. This contributed to reducing the possibility of implementing an effective search.
- b) The last radar information that the air traffic control service had from the helicopter was not recorded and could consequently not be verified.
- c) The helicopter's Emergency Locator Transmitter (type ADELTA) was smashed in the impact with the surface of the sea and consequently did not transmit any emergency signals. The Emergency Locator Transmitter was therefore of no assistance in warning of the accident or determining the site of the accident.
- d) The crew was dressed in non-insulated flying suits and was otherwise lightly clothed. This gave the crew a reduced survival capacity in the event of a controlled emergency landing at sea.
- e) The passengers were dressed in insulated survival suits.
- f) Autopsy reports show that everyone was killed as a result of the impact with the surface of the sea.
- g) It would not have been possible to survive the impact with the surface of the sea.

3.2 **Significant investigation results**

The AAIB/N has assessed the following investigation results as being particularly important from the perspective of flight safety, in that these factors had direct consequences or could have been of indirect significance to the course of events:

- a) The investigation has proven that the hardmetal coating on the R/H splined sleeve did not comply with specifications in several areas. In combination with several

scratches in the coating, this reduced the wear resistance of the coating to a significant extent.

- b) The main gearbox M170 had non-conformity in the vibration pattern recorded by HUMS in relation to other equivalent MGBs in the company's fleet. A similar vibration pattern was recorded from MGB nos. M136 and M665 (with parts from LN-OPG and MGB no. M136). Examinations and tests which have been conducted indicate a connection between non-conformity in the vibration pattern and certain combinations of input pinion / 8 000 RPM wheel. The AAIB/N has not made any further examination of the effects of these vibrations, and cannot draw any final conclusion from this with respect to causal factors.
- c) The R/H splined sleeve did not have the prescribed O-ring and this contributed to an increase in the freedom of movement between the splined sleeve and the splined flange. However, it seems evident that the fatigue cracks in the splined sleeve did not initiate as a result of a missing O-ring, but that the subsequent crack propagation in the splined sleeve may have been hastened by this deficiency.
- d) The inspection of the coupling between the Bendix shaft and the MGB performed on 22 August 1997 did not comply with the minimum requirements specified by the manufacturer.
- e) The AAIB/N believes that a series of fatigue cracks arose in the splined sleeve in question during the period 121 to 62 flying hours prior to the accident. This corresponds to the period 22 to 31 August 1997. However, it is probable that the cracks began to form several dozen hours before 31 August.
- f) A HUMS accelerometer with an "alarm", that monitored the problem area, was out of operation at the time of the accident. The AAIB/N finds reason to believe that the accelerometer could have recorded and given notification of the trend in question, in time to have allowed the accident to be prevented.
- g) The part of HUMS that was serviceable recorded and saved information showing that something abnormal had started to happen in the drive train between the R/H engine and the main gearbox several days prior to the accident. This information remained saved in a central database and had to be analysed manually to disclose the trend.
- h) The installation of HUMS was not an aviation authority requirement and was consequently done on a voluntary basis. The company did not set any requirements for the system's serviceability. This led to it being possible for parts of the system to be out of service for lengthy periods without there being any consequences for the use of the helicopter.
- i) Safety was the only purpose for installing HUMS. After the authority approval, the attitude the NCAA took to HUMS was passive. This led to HS not undertaking any systematic ongoing assessment of the requirement elements based on experience from the operational phase, thereby not exploiting the safety potential of the system.
- j) The crew had not been such trained in the engine's regulation and control system that they could realize the seriousness of the indications given to them. Such knowledge and insight could not be expected from the crew that was trained by the company based on information from the aircraft manufacturer. In addition, there

were no procedures or checklists that covered the indications observed. The crew was therefore not equipped to understand the degree of seriousness of an OVSP light that came on at irregular intervals during the last part of the flight.

- k) The cracking of the splined sleeve gradually brought about the release of the lock washer and consequential failure of the Bendix shaft.
- l) The shaft fracture led to the loading on the R/H power turbine being released and to the RPM therefore increasing.
- m) The fracture of the Bendix shaft led to major vibrations in the aft part of the engine, which then led to a failure in the system that records RPM on the R/H engine's power turbine.
- n) Missing RPM information led to the engine's system for RPM regulation and overspeed protection being put out of operation.
- o) As a consequence of the regulating system design, the missing RPM information to the EECU then led to the gas generator being supplied with fuel to achieve 104% Ng.
- p) When the gas generator increased RPM towards 104%, the power turbine with a "blinded" overspeed protection reached an RPM of approx. 175%, at which point it burst.
- q) Parts of the R/H power turbine were ejected with great force and destroyed the L/H engine and cut vital control rods in the helicopter.
- r) The helicopter was uncontrollable after the control rods were cut.
- s) The shaft between the engine and the main gearbox has design shortcomings with respect of safety. In this case a loose lock washer did lead to a failure in the shaft (Bendix shaft), the system for engine RPM regulation and the system for overspeed protection.
- t) The helicopter design in question is poorly protected against uncontained engine failures. Such engine failures can easily lead to serious consequential damage.

4 RECOMMENDATIONS

On the basis of analyses of recorded data from the helicopter's IHUMS, the AAIB/N gave the following recommendation to the Norwegian Civil Aviation Authority on 17 September 1997 (nine days after the accident):

"The AAIB/N therefore wishes to recommend that the Norwegian Civil Aviation Authority orders operators flying this type of helicopter, and who use IHUMS, to review the available engine drive shaft data. The values and any changes in these values should be reported and thus form the basis of an assessment of whether such monitoring ought to be made mandatory, the frequency at which it should be carried out and the limits that should be established." (Translated from the original Norwegian)

Based on information that emerged during the examination of the system for engine RPM control, the AAIB/N sent the following recommendation via the Norwegian Civil Aviation Authority to the helicopter/engine manufacturer on 14 November 1997:

"Eurocopter/Turbomeca makes a critical review of the ECU-logic reaction in situations when valid Nf information is lost."

These recommendations are no longer current since they are covered by measures that have already been implemented or by recommendations given in this report. The AAIB/N has not found it necessary to issue more interim recommendations since the helicopter/engine manufacturers have independently implemented measures which the AAIB/N believes have taken care of flight safety in those areas in which the accident exposed failures. The following are among these measures:

- in Fax Alert No. 1075, dated 19 September 1997, Turbomeca ordered all operators of Makila engines to stop an engine if its OVSP light came on while the other engine was running satisfactorily. This was followed by an AD on 22 October of the same year
- in Service Telex 63.00.54, dated 2 October 1997, Eurocopter ordered all civil operators of AS 332s to measure the vibration level on the 23 000 RPM coupling every 25 flying hours. This was followed by an AD on 22 October of the same year
- in addition, Eurocopter has issued several orders regarding improvements in maintenance.

The Norwegian Civil Aviation Authority has been kept constantly updated on the investigation and the findings that have been made. The Norwegian Civil Aviation Authority has thus had good opportunities of assessing ongoing flight safety on an independent basis.

The recommendations below contain references to the AS 332L1 model. However, the AAIB/N assumes that the recommendations will be made applicable to other civil versions of the AS 332 where this is relevant.

It is recommended that:

The Norwegian Civil Aviation Authority [Luftfartstilsynet], in collaboration with the other civil aviation authorities around the North Sea basin, should assess whether requirements should be introduced regarding the use of HUMS in passenger transportation by helicopter within the area. This assessment should among others cover requirements for serviceability, analysis of data, introduction of industrial standards and standardisation of the requirements within JAA.

(Recommendation no. 34/2001)

In collaboration with the civil aviation authorities in France, the Norwegian Civil Aviation Authority [Luftfartstilsynet] should direct Eurocopter to assess whether the requirements for final production control of the splined sleeve on AS 332L1s are sufficient. (Recommendation nr. 35/2001)

In collaboration with the civil aviation authorities in France, the Norwegian Civil Aviation Authority [Luftfartstilsynet] should direct Eurocopter to revise the maintenance requirements for the splined sleeve and the splined flange on the AS 332L1. (Recommendation nr. 36/2001)

In collaboration with the civil aviation authorities in France, the Norwegian Civil Aviation Authority [Luftfartstilsynet] should direct Eurocopter to revise the overhaul criteria for the input pinion and the 8 000 RPM wheel on the AS 332L1. (Recommendation nr. 37/2001)

In collaboration with the civil aviation authorities in France, the Norwegian Civil Aviation Authority [Luftfartstilsynet] should assess the measures which can be introduced to improve the existing design of the AS 332L1 with regard to the RPM regulation of the engines, the systems for RPM limitation, the drive train between the engine and the MGB, and the protection against uncontained engine failures. (Recommendation nr. 38/2001)

In collaboration with the civil aviation authorities in France, the Norwegian Civil Aviation Authority [Luftfartstilsynet] should direct Eurocopter to optimise the information it issues to all operators of the AS 332L1 regarding the function and indication of the systems for engine RPM regulation and RPM limitation. (Recommendation nr. 39/2001)

In collaboration with the civil aviation authorities in France, the Norwegian Civil Aviation Authority [Luftfartstilsynet] should direct Eurocopter to implement a project to map out any connections which might exist between vibrations occurring in the main gearbox and loadings occurring in the drive train between the engine and the main gearbox. (Recommendation nr. 40/2001)

In collaboration with the civil aviation authorities in France, the Norwegian Civil Aviation Authority [Luftfartstilsynet] should assess whether to direct Eurocopter to draw up a plan for increasing the user-friendliness and clarity of the maintenance instructions and the information provided by the factory. (Recommendation nr. 41/2001)

In collaboration with the Norwegian Post and Telecommunications Authority [Post- og Teletilsynet], the Norwegian Civil Aviation Authority [Luftfartstilsynet] should assess whether Emergency Locator Transmitters of the ADEL T type, model CPT 600, should be approved for use in Norwegian aircraft. (Recommendation nr. 42/2001)

On the basis of this report, the Norwegian Civil Aviation Authority [Luftfartstilsynet] should carry out an assessment of the documented quality system at technical division at Helikopter Service AS with regard to appropriateness and integrity. (Recommendation nr. 43/2001)

The Norwegian Civil Aviation Authority [Luftfartstilsynet] should assess whether aviation companies should be directed to draw up a plan, as part of their flight safety

work, of how skills in Human Factors in Aviation Maintenance are to be acquired and integrated. (Recommendation nr. 44/2001)

The recommendations below are being advanced to the Norwegian Civil Aviation Authority [Luftfartstilsynet] for follow-up:

The Norwegian Civil Aviation Administration [Luftfartsverket] should make arrangements to ensure that all radar information that is available to the air traffic control service is recorded so that the Norwegian Joint Rescue Coordination Center can immediately gain access to the data as required. (In addition, please refer to the recommendation from the AAIB/N in report no. 02/97.) (Recommendation nr. 45/2001)

Helikopter Service AS should draw up a strategic plan with clear objectives for the use of HUMS. (Recommendation nr. 46/2001)

Helikopter Service AS should review its procedures for the revision and approval of maintenance programmes (the MRM). (Recommendation nr. 47/2001)

Helikopter Service AS should carry out a review of the system of Main Tasks with regard to avoiding disparate views of the status of the document among the company's licensed aircraft technicians. (Recommendation nr. 48/2001)

Helikopter Service AS should undertake an assessment of the interface between tasks of work that fall within the areas of liability for licensed aircraft technicians and other specialist groups. (Recommendation nr. 49/2001)

Helikopter Service AS should assess the clothing of the crew with a view to increasing survivability in the event of emergency landings at sea. (Recommendation nr. 50/2001)

Helikopter Service AS, based on experience gained from this accident, should assess whether to provide pilots with enhanced training on the regulation and control systems of the engine. (Recommendation nr. 51/2001)

(Please note that some of these recommendations had been acted upon before the report was issued.)

5 APPENDIX

(See part II of the report)

Figure 1 – 75

Appendix A	MET 63.10.00.602
Appendix B	MET 71.00.00.401
Appendix C	Main Task 72

Appendix D	Pages from Super Puma Instruction Manual
Appendix E	Plot (Flight time – Event – Vibrations)
Appendix F	ECF comments to draft report

Abbreviations

Information from the following reports has been used:

- AAIB Incident report 2/98 "Report on the incident to Aerospatiale AS332L Super Puma, G-PUMH over North Sea on 27 September 1995"
- AAIB/N "Flight recorder report" from meeting at Farnborough on 9 and 10 December 1997
- AAIB/N Report no. 02/98 "Air accident involving Eurocopter Super Puma 332L, LN-OBP, in the North sea on 18 January 1996, approx. 40 NM south-west of Sola, Norway"
- Eurocopter "Minutes of meeting, AS 332L1 - Accident LN-OPG, Investigations results and airworthiness follow-up 3rd and 4th February 1999"
- DNV Report No. 97-1378 Revision no. 01, "Failure investigation of a broken tie bolt P/N 332A32-3233-00"
- DNV Report No. 98-1118 Revision no. 02, "Examination of a fractured splined sleeve from the Super Puma helicopter, LN-OPG"
- DNV Report No. 98-1276 Revision no. 01, "Examination of a fractured Bendix shaft assembly from the Super Puma helicopter AS 332, LN-OPG"
- DNV Report No. 99-1018 Revision no. 01, "Examination of micro-cracks and hardmetal surface coating for helicopter splined sleeves" with "Appendix A"
- DNV Report No. 99-1265 Revision no. 01, "Evaluation of crack propagation periods based on the examination of components from the Super Puma helicopter AS 332, LN-OPG"
- DNV Report No. 2000-1121 Revision no. 01, "Super Puma Helicopter LN-OPG, Examination of Main Rotor Blade Sleeve and Pitch Change Rod"
- DNV Report No. 2000-1129 Revision no. 01, "Examination of a fractured Liaison tube assembly from the Super Puma helicopter LN-OPG"
- DNV Report No. 2000-1210 Revision no. 01, "Examination of Speed Probes and Phonic Wheels from the Power Transmission of the Super Puma Helicopter LN-OPG"
- DNV Report No. 2000-1255 Revision no. 01, "Examination of Flight Control Rods and a Suspension Bar from the Upper Structure Area. Super Puma Helicopter AS 332, LN-OPG"

- GKN Westland Helicopters Research paper RP 1035 "An assessment of the vibration health monitoring parameters from the Helicopter Service Super Puma MK I Helicopters"
- Helicopter Service "Air safety report No. 97/326, 8 September 1997"
- R.J.Waldron&Company (1987) LTD. Report File 98-110 "Failure Analysis, Main gearbox input components, AS332L1 Super Puma N171EH, ERA Aviation inc."
- SINTEF Report no. STF75 A90008 "Helicopter Safety Study"
- Turbomeca Investigation Report No. 937D "Disassembly of the engines and supplementary examinations"
- Turbomeca Investigation Report No. 1 491 "Makila - 08/09/1997 Accident LN-OPG, Inspection of engine accessories"
- Brüel & Kjær "Report on findings during test and measurements at Helicopter Service Monday May 8th through Friday May 12th, 2000"
- SINTEF report STF24 F00260 "Fatigue assessment of cracks in splined sleeve part of helicopter".

HAVARIKOMMISJONEN FOR SIVIL LUFTFART (the AAIB/N)
Lillestrøm, 9 November 2001

**AIR ACCIDENT 8 SEPTEMBER 1997 IN THE NORWEGIAN SEA
APPROX. 100 NM WEST NORTH WEST OF BRØNNØYSUND,
INVOLVING EUROCOPTER AS 332L1 SUPER PUMA, LN-OPG,
OPERATED BY HELIKOPTER SERVICE AS**

PART II

FIGURE 1 – 75

APPENDIX A – F

ABBREVIATIONS

TRONDHEIM - BODØ FIR

HELICOPTER ROUTES - QNH SETTING AREAS

1:2 000 000

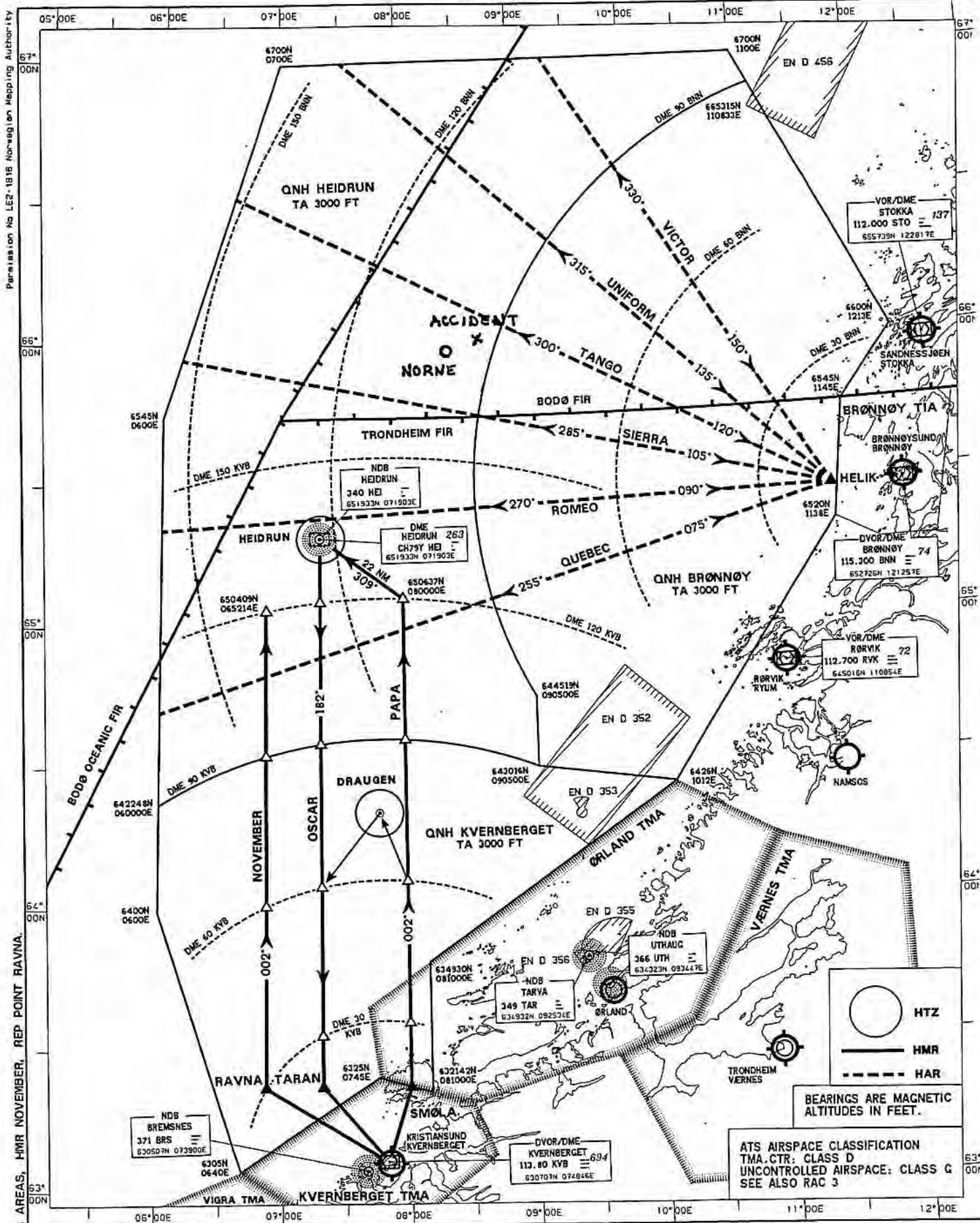

HELIK	(652722N 113700E)	R-270 BNN DME 15
RAVNA	(632247N 065214E)	R-304 KVB DME 30
SMØLA	(632300N 080000E)	R-020 KVB DME 16, 7
TARAN	(632300N 071900E)	R-322 KVB DME 20, 9

Fig. 2

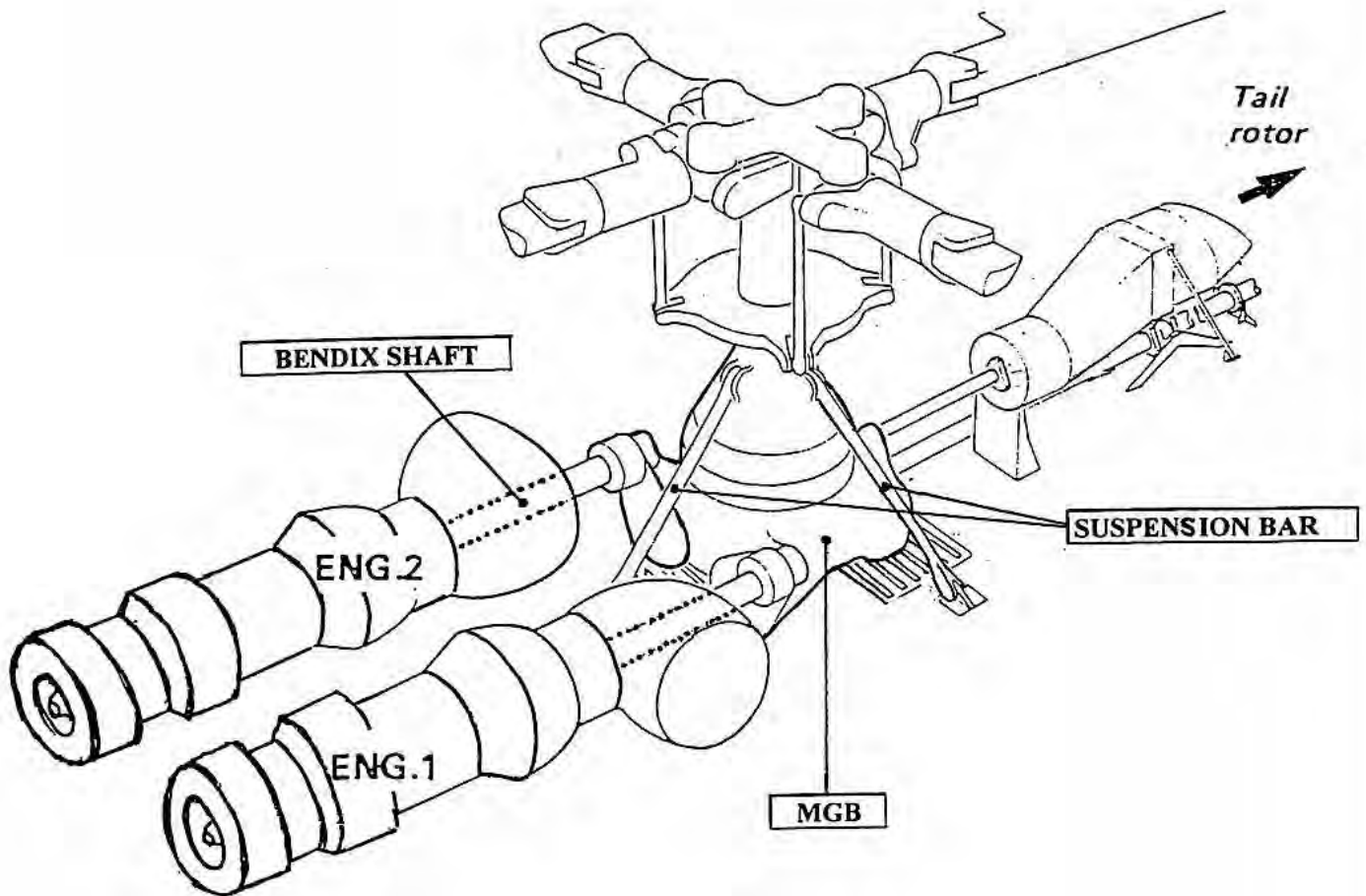
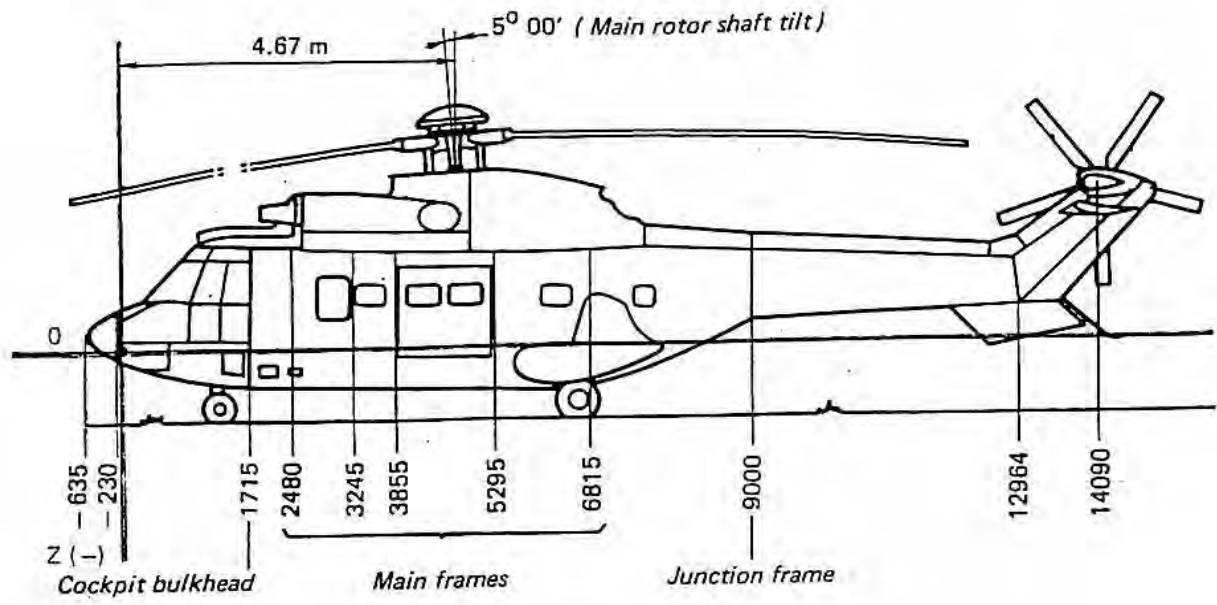

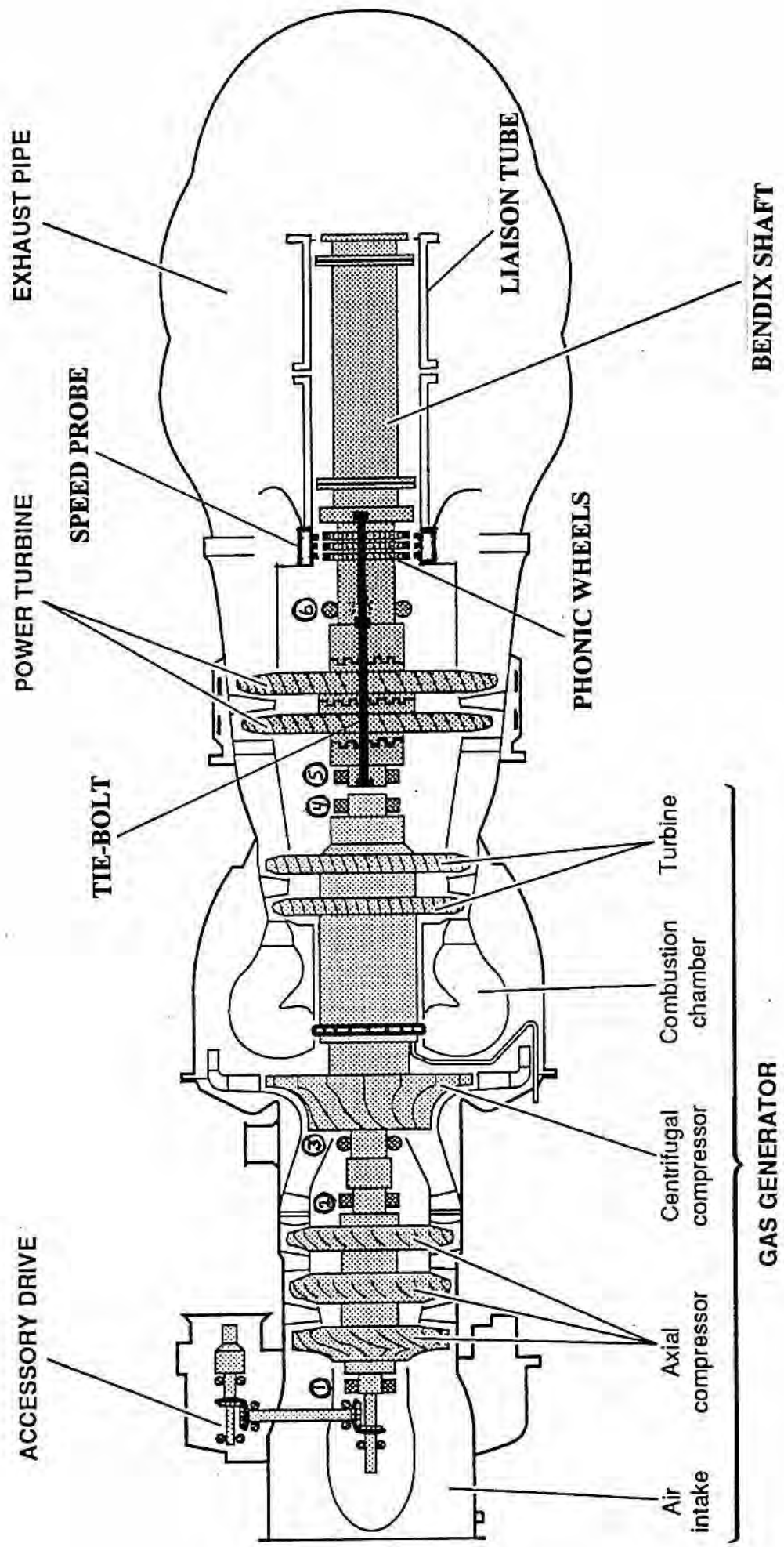

ENGINE GENERAL DESCRIPTION

Fig. 5

MAIN GEAR BOX

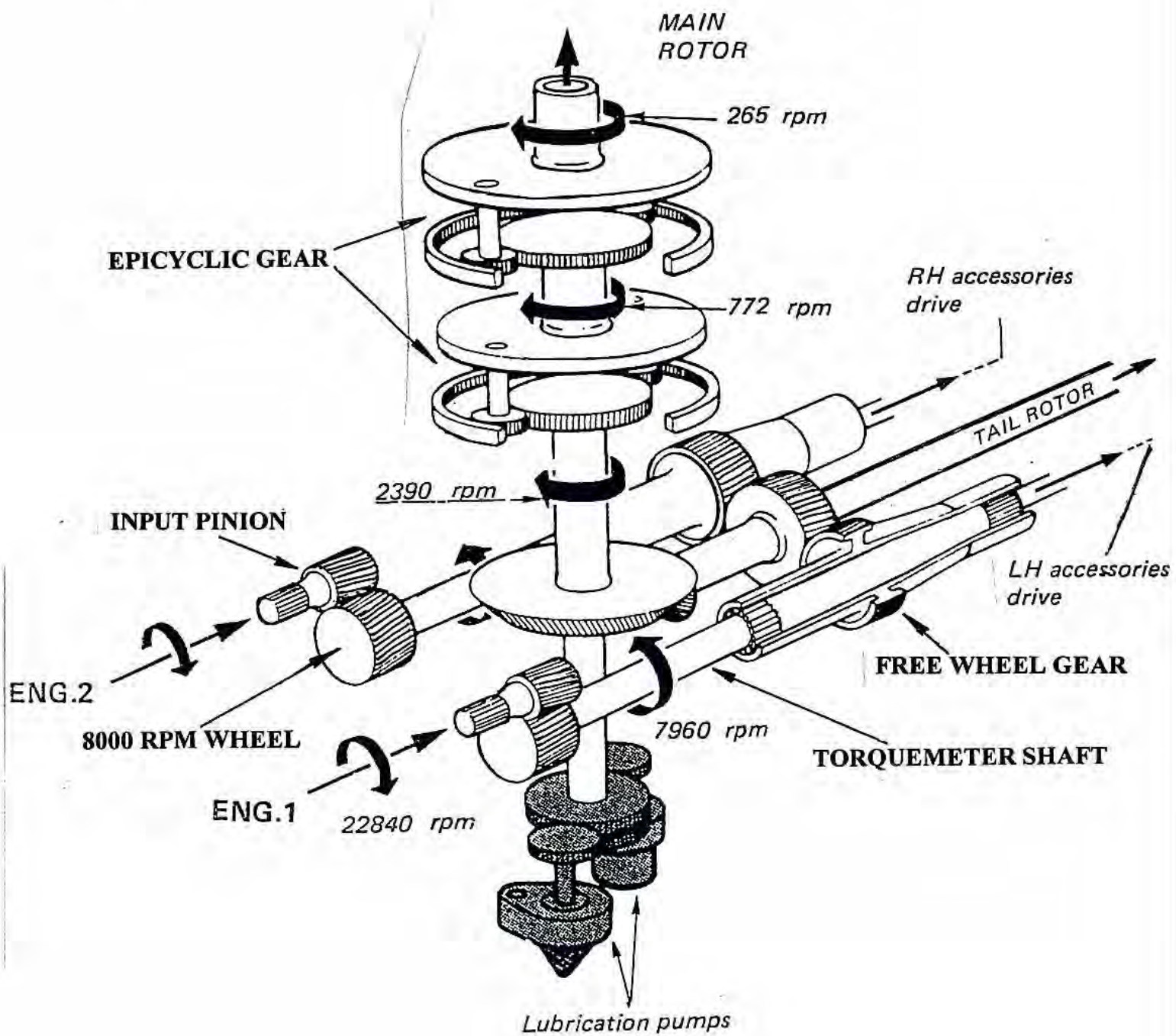

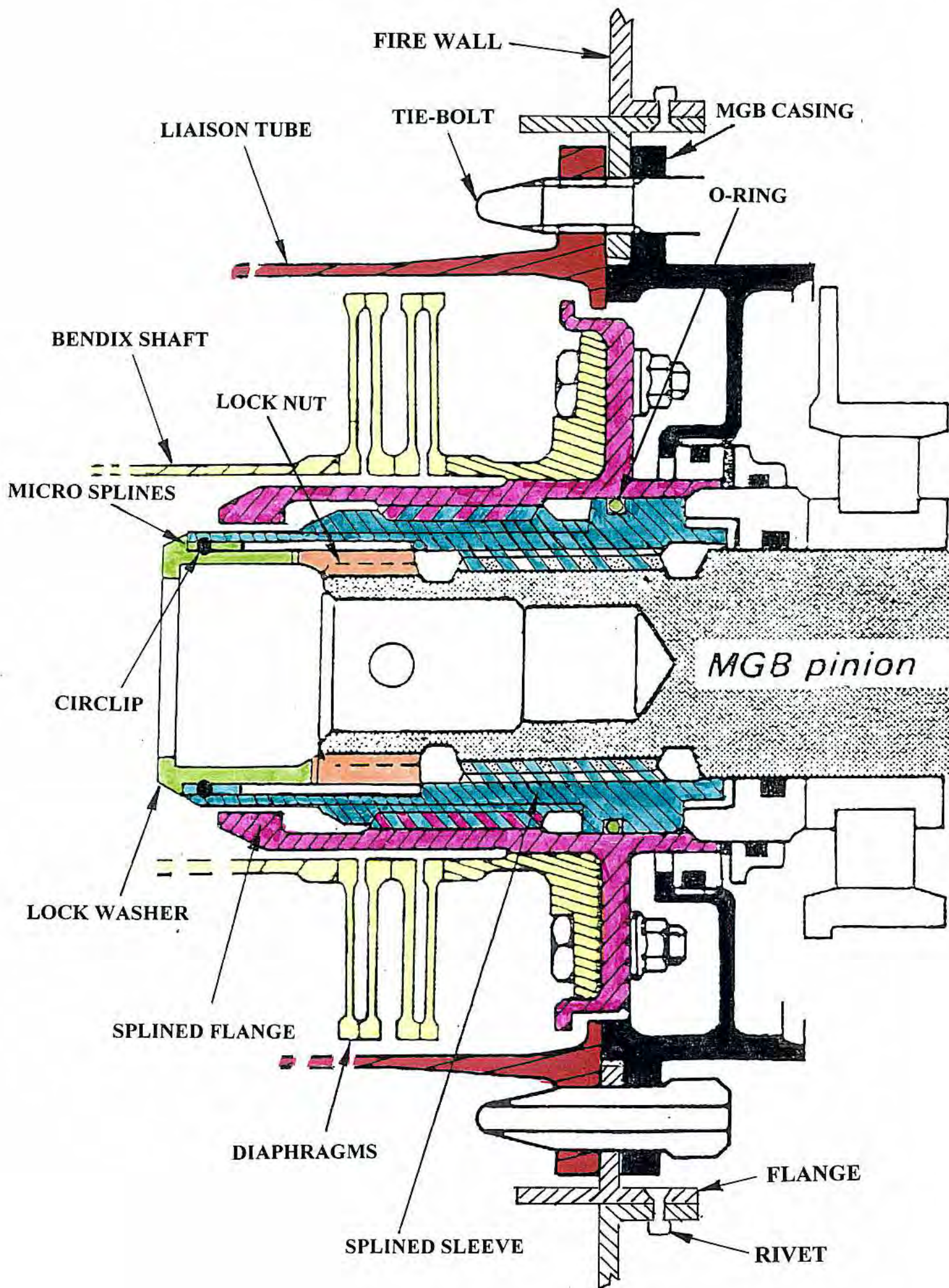

HUMS ACCELEROMETERS

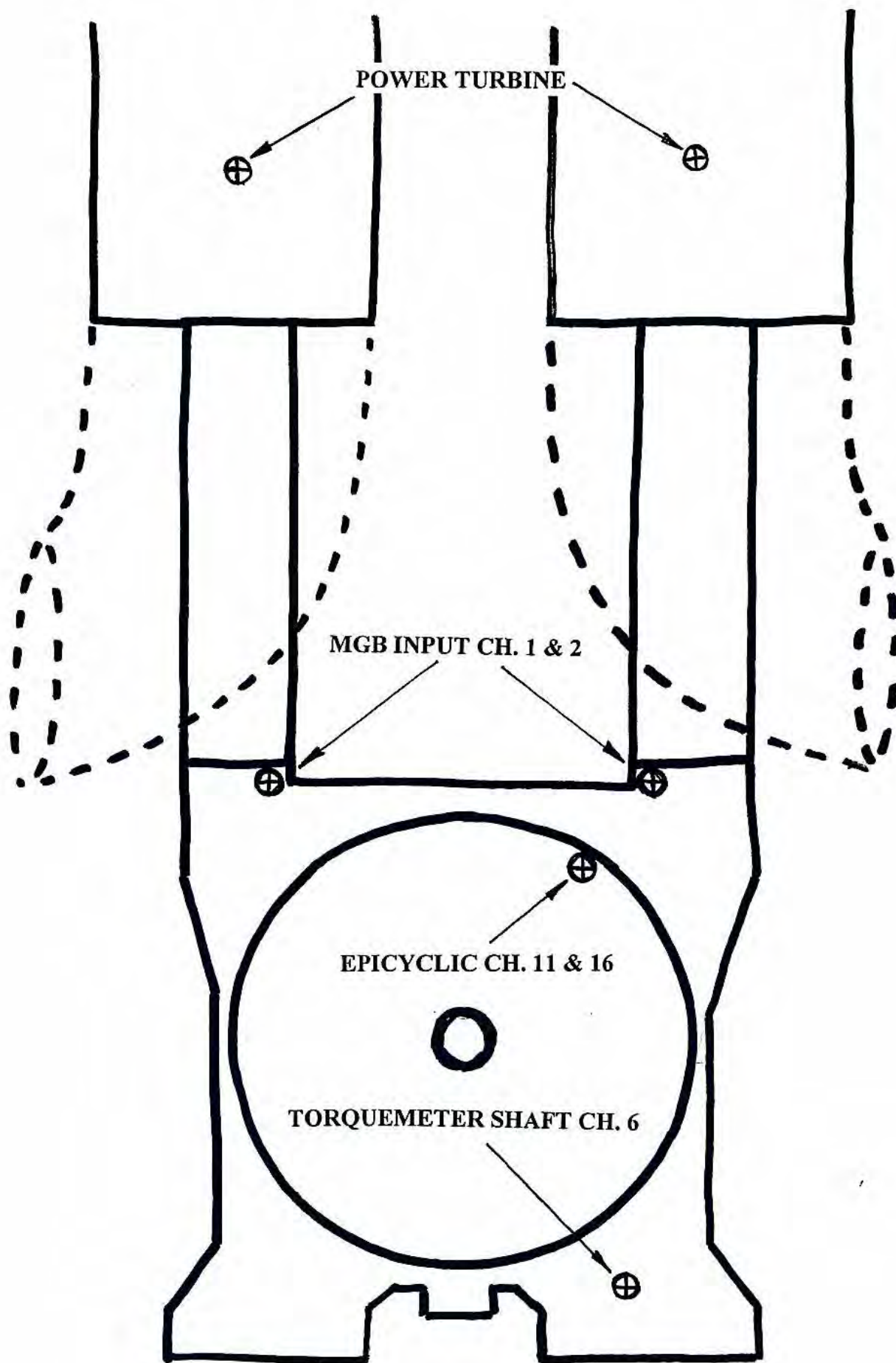

WEAR CRITERIA : GEAR WHEEL
332A32-2150

* VITAL PART *

R

REFERENCE : 332A32-2150 VALABLE POUR POINT : -10 -11 -12
PART NUMBER : APPLICABLE TO DASH :
PIECE N° N° 332A32-2150/-28/-29/-31/-32 ENS. SUP. Réducteur avant
UNEQUIPPED PART NEXT ASSY Front reduction G.B.

CRITERES D'USURE : ROUE
WEAR CRITERIA : WHEEL GEAR

* PIECE VITALE * * VITAL PART *

TEXT(E)

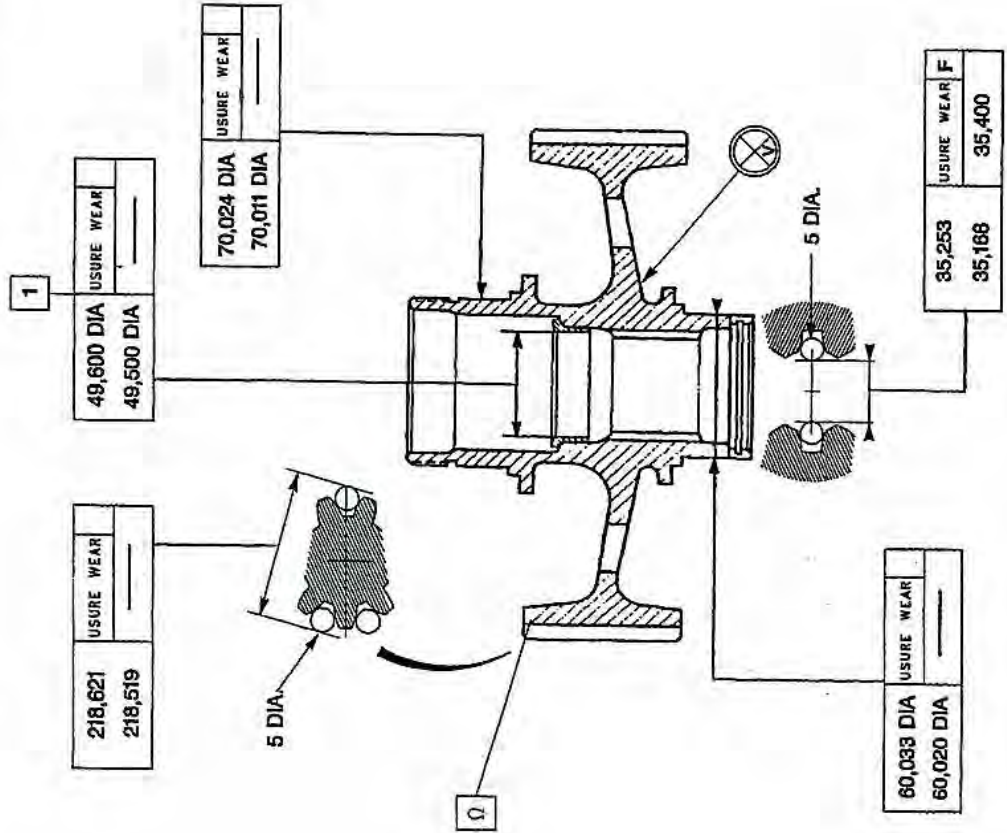

C.T CONFORME A LA FICHE DE CRITERES D'USURE DEPOSEE
WORK CARD IN COMPLIANCE WITH THE REGISTERED WEAR CRITERIA SHEET

ITEM	FIG	OPE	DESCRIPTION REPAIR RECONDITIONING	SHEET No.	REMARKS
220	4	1	60.00.30.800 <u>General Notes</u> 1 Dimensions given on reinforcing bush 332A32-2333-20 (POST MOD. 52086). Effective for -10 -11 -12. For part -32 dimensions are identical (No reinforcing bush).		
		E2	Reparation cancelled		
		E3	Reparation cancelled		

WORK CARD IN COMPLIANCE WITH THE REGISTERED WEAR CRITERIA SHEET

R

eurocopter

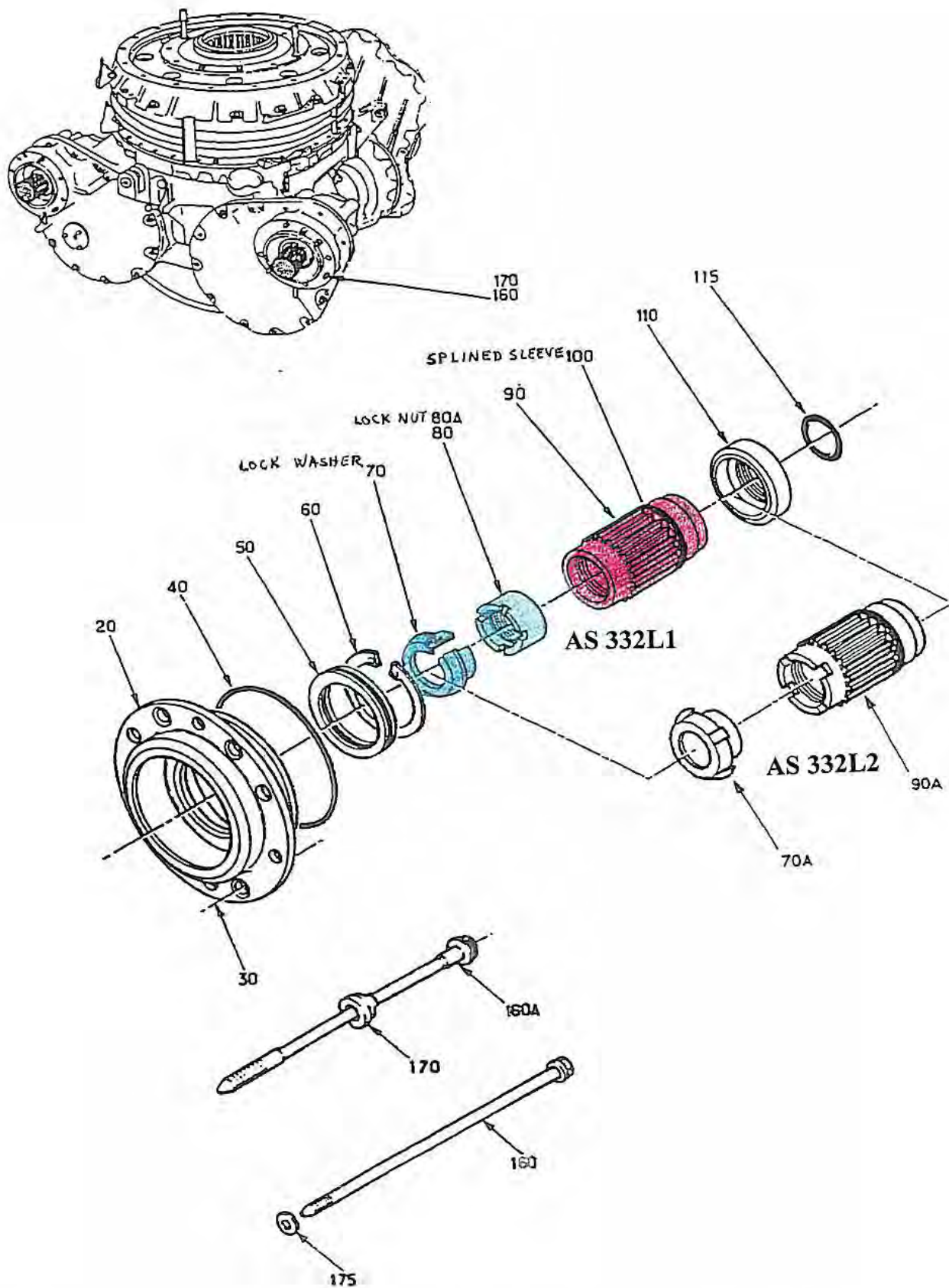

FIG. 1
REDUCTEUR AVANT
REDUCTION GEAR, FORWARD

AS 332 CIVIL

63.28.10

FREQUENCY SPECTRUM AT APPROXIMATELY T=0

APPENDIX 6 - Figure 10

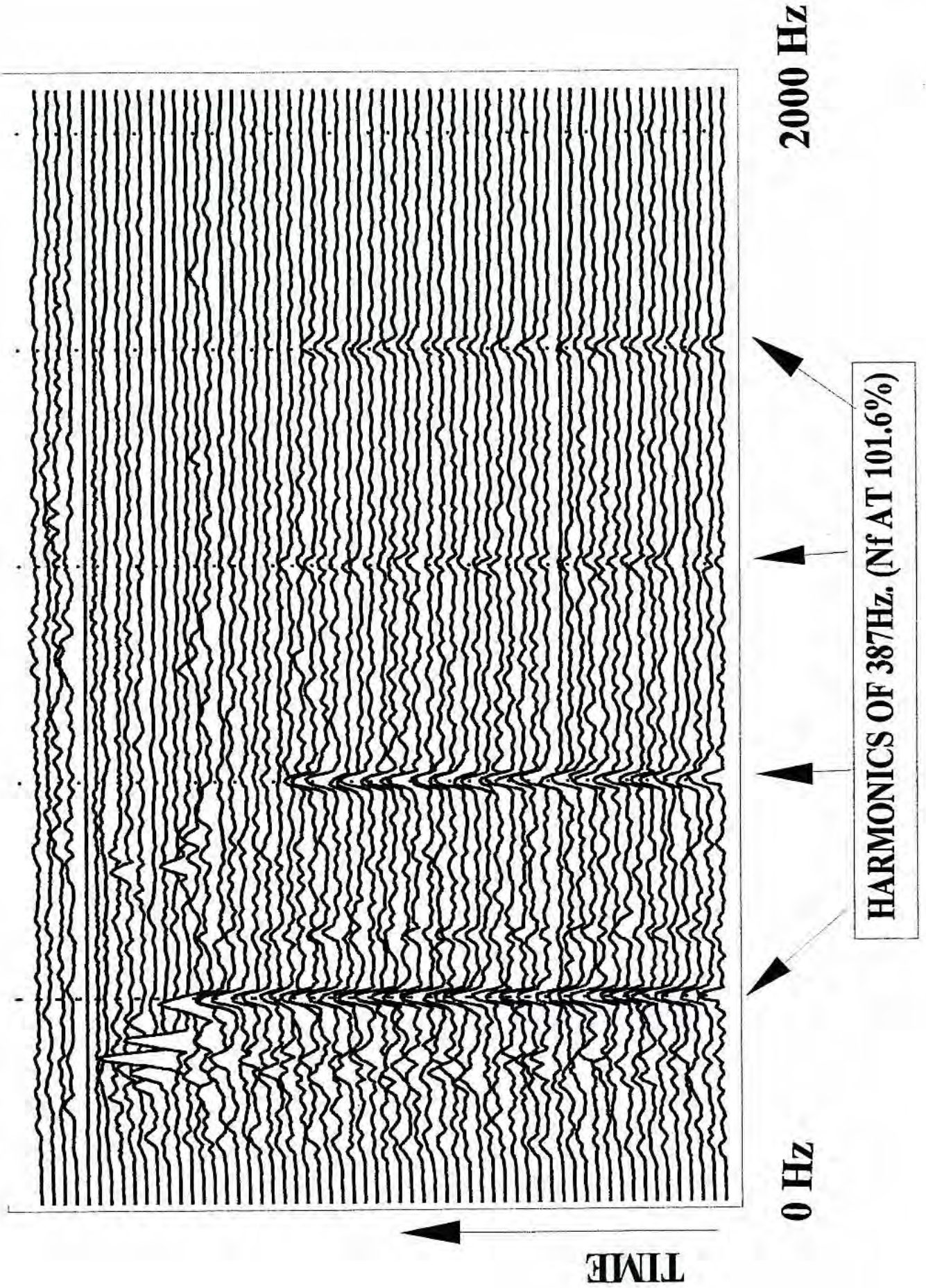

Fig. 11

APP 4

ACCIDENT TO SUPER PUMA LN-OPG on 8 Sept. 1997

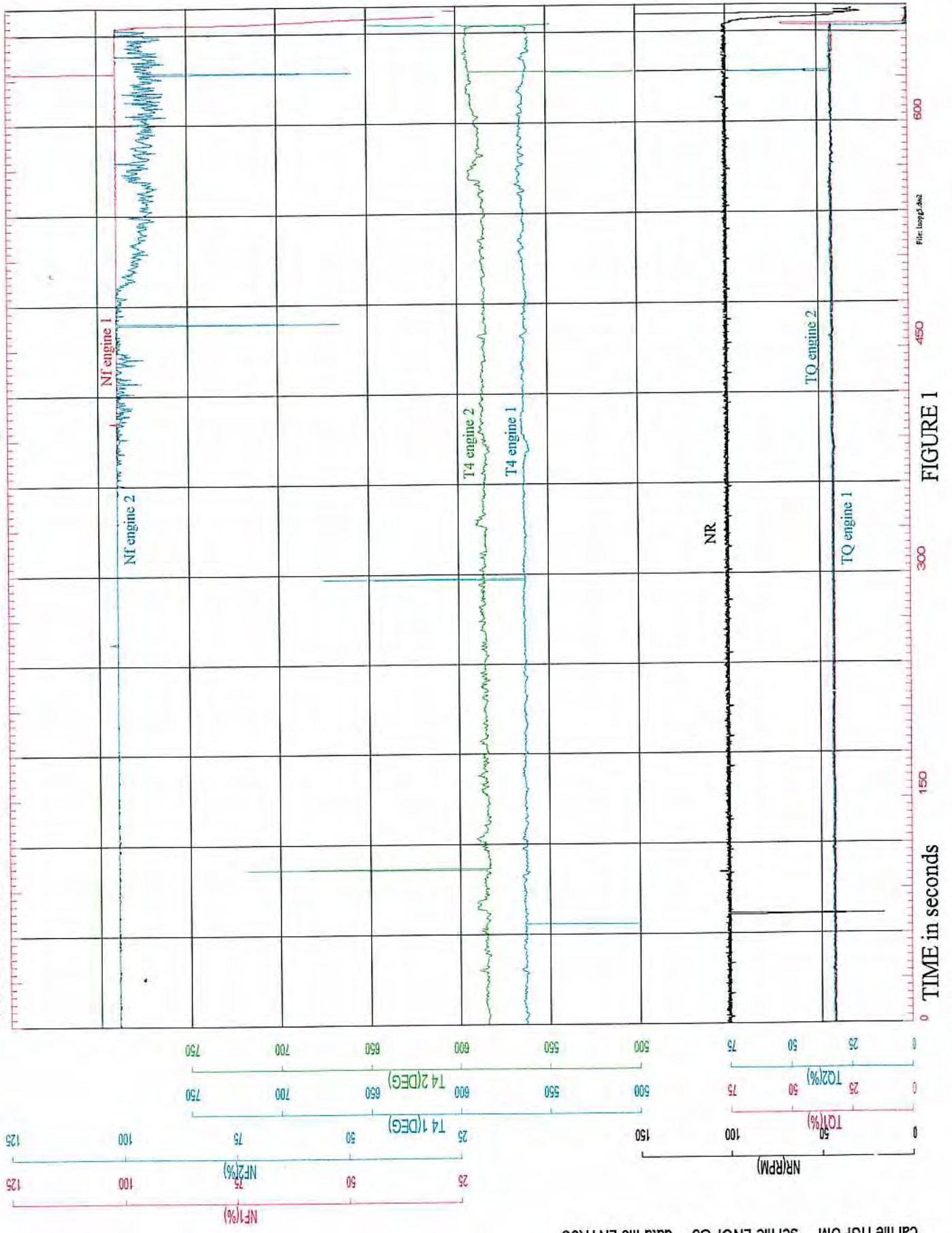

FIGURE 1

Air Accidents Investigation Branch.....plotted on Wed Sep 17 08:37:07 1997
cal file HSPUM sel file LNOPG6 data file LNTK6C

APPENDIX 7 - FIGURE 1A
SPECTROGRAM OF AREA BETWEEN "THUD" AND "CRASH"

Sampling: 44100 Hz
FT size: 8192
Veraging: 1
Window: Hamming
Overlap: 0 %

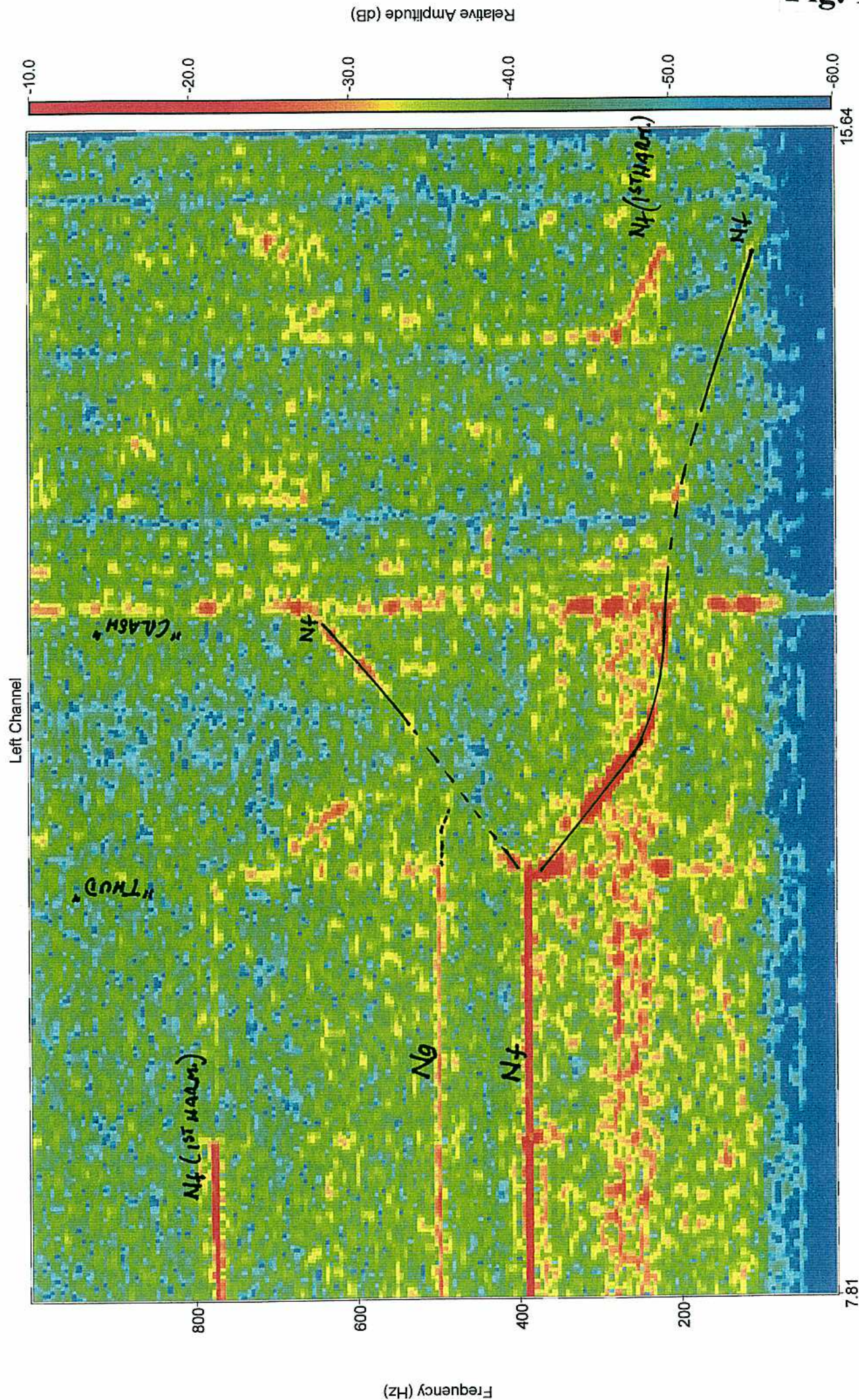
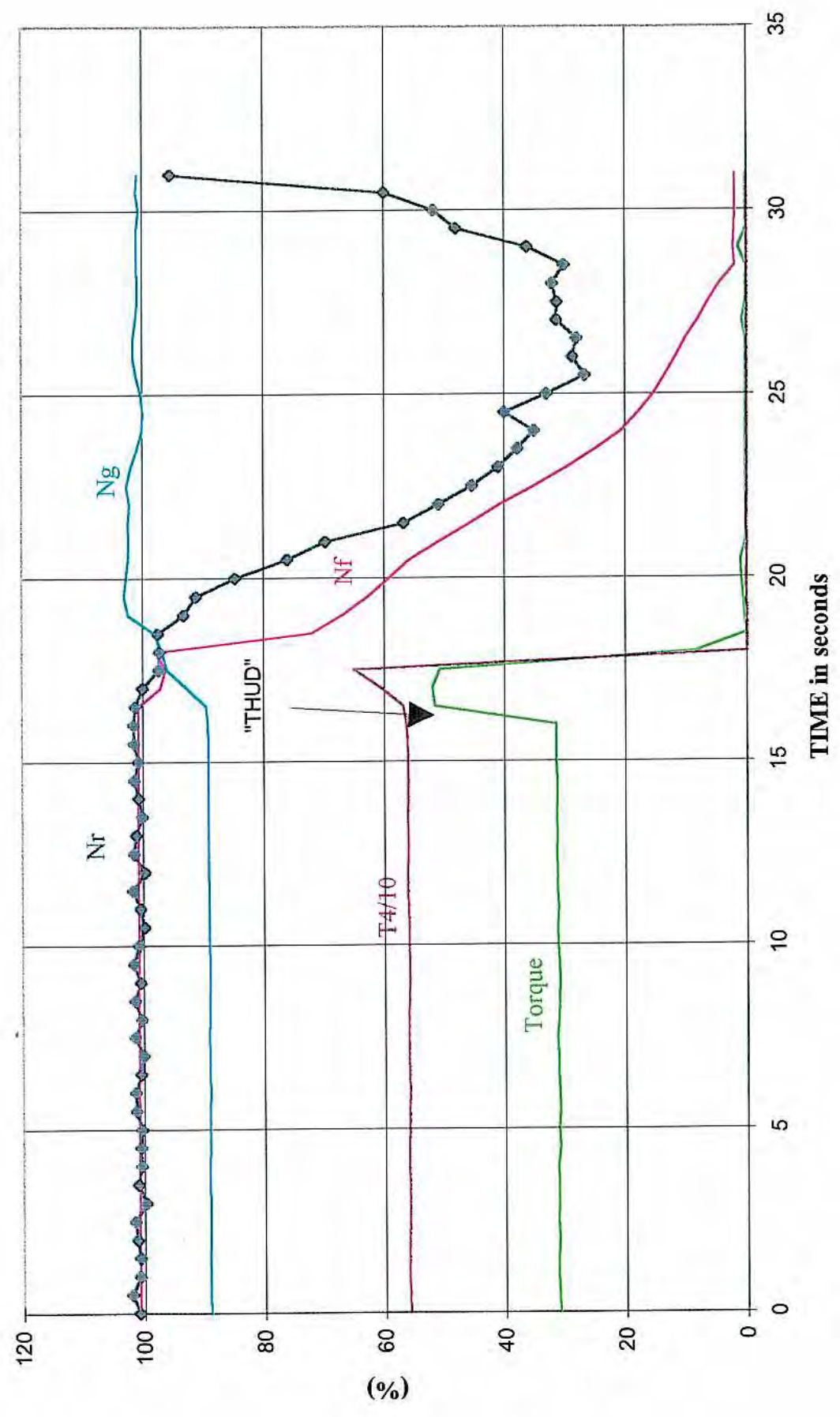

Fig. 12

APP 4

Fig. 13

LN-OPG ACCIDENT - Engine 1 parameters



Appendix 4 Figure 4

LN-OPG ACCIDENT - Engine 2 parameters

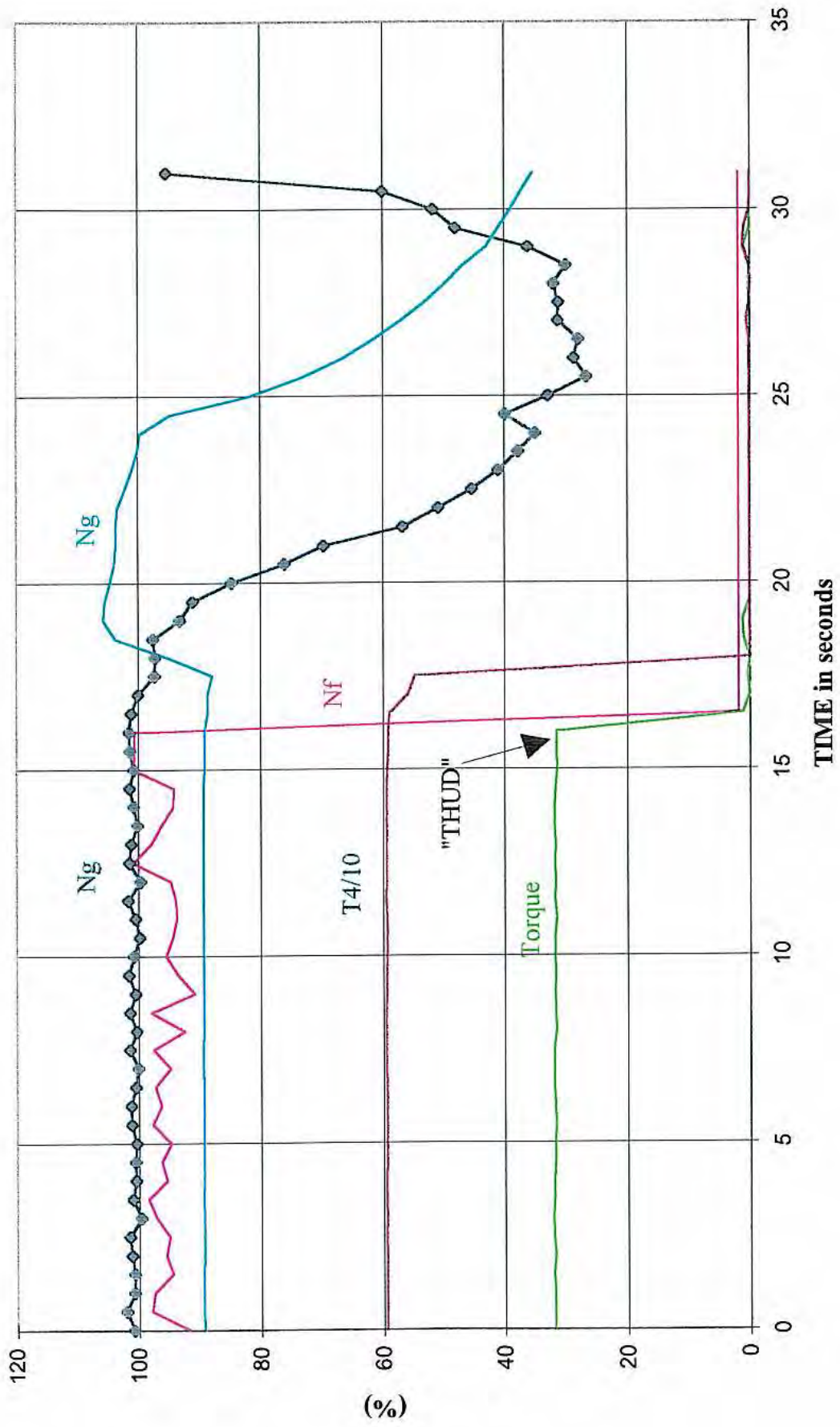
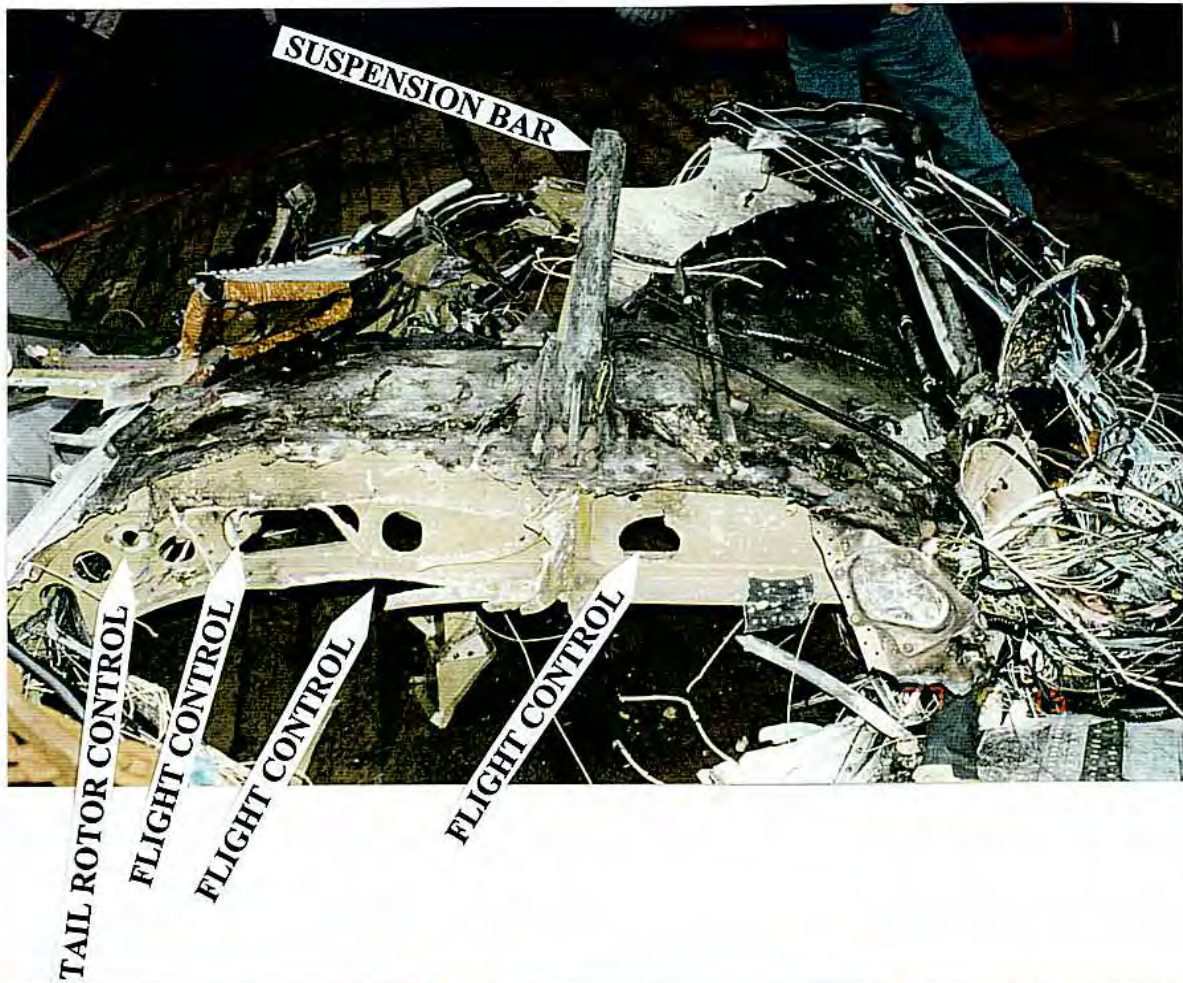
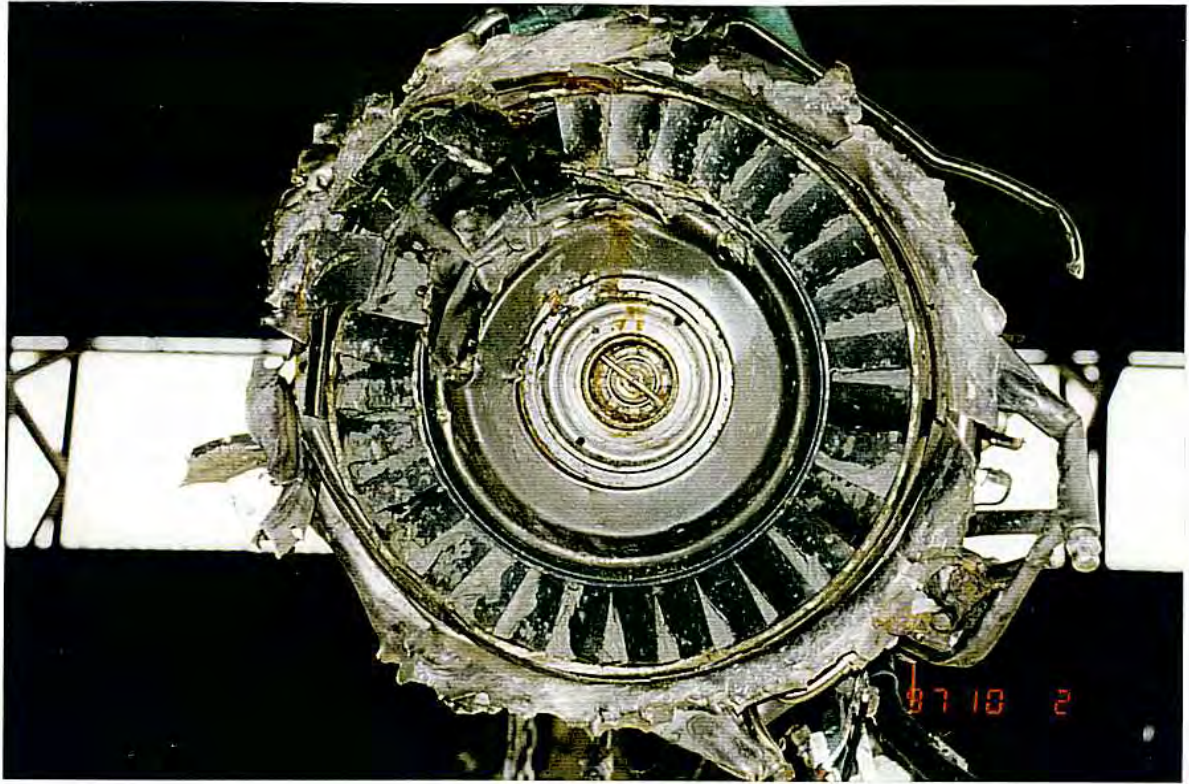

Fig. 14

Appendix 4 Figure 5



POWER TURBINE CASING, L/H ENGINE



R/H ENGINE, REAR VIEW

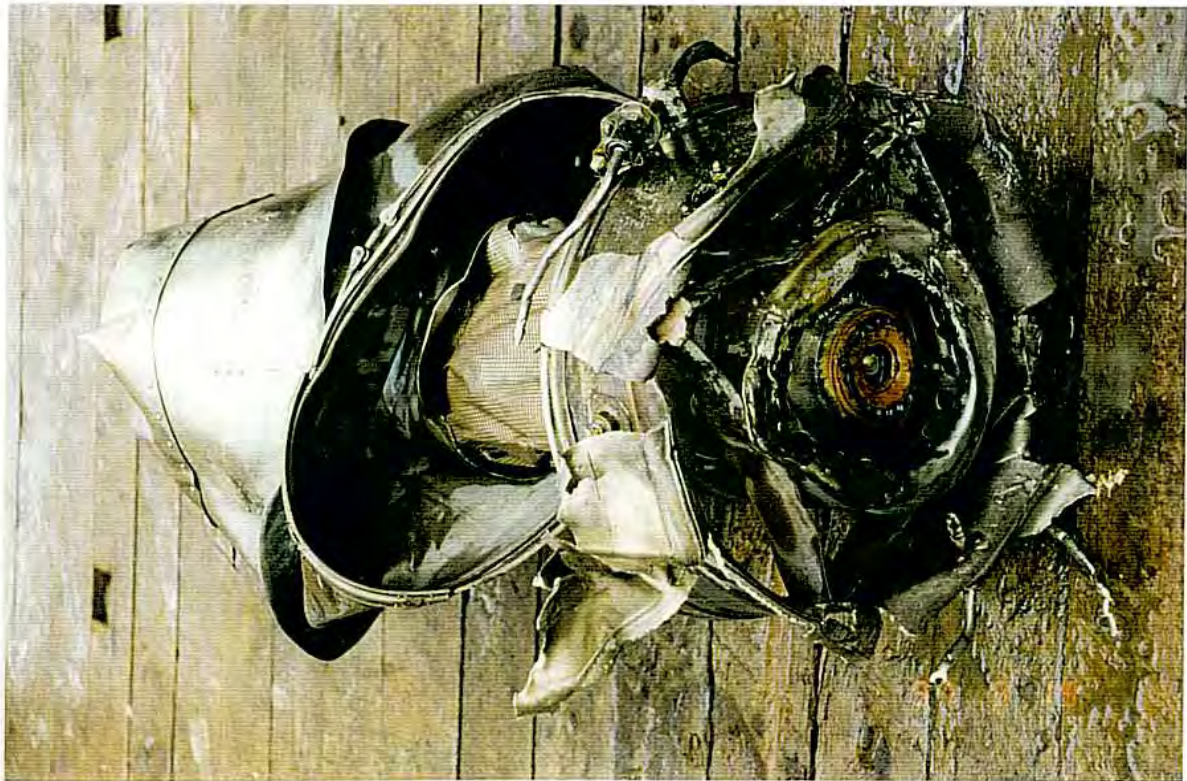

AFT PART, R/H ENGINE

Fig. 17 a b

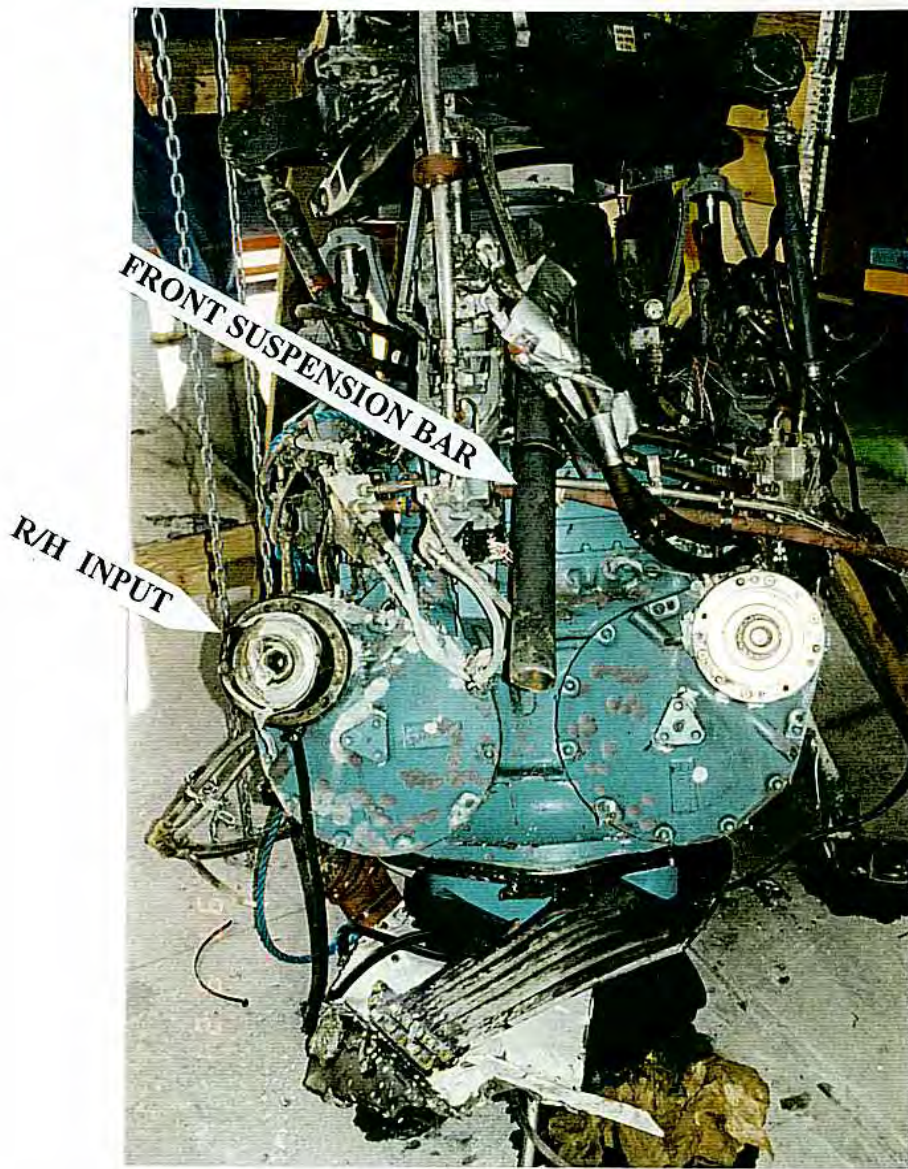

MAIN GEAR BOX, FRONT VIEW

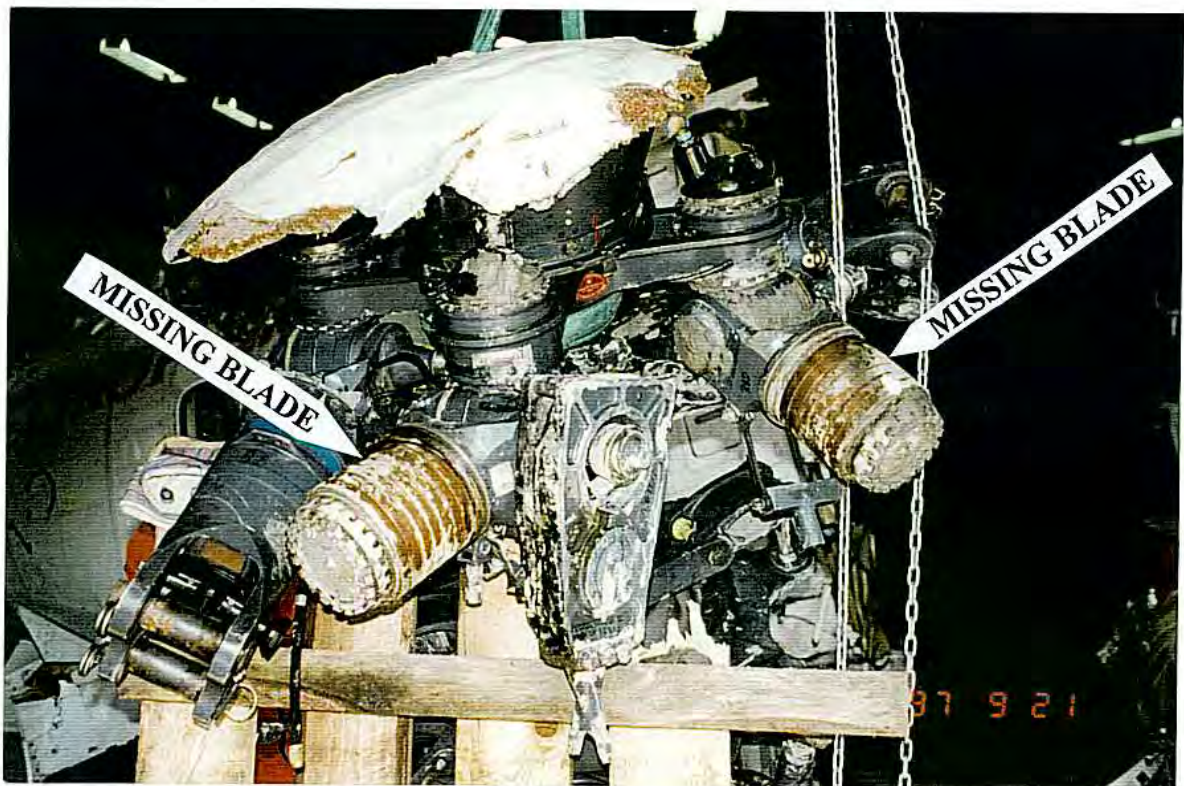

MAIN ROTOR HEAD

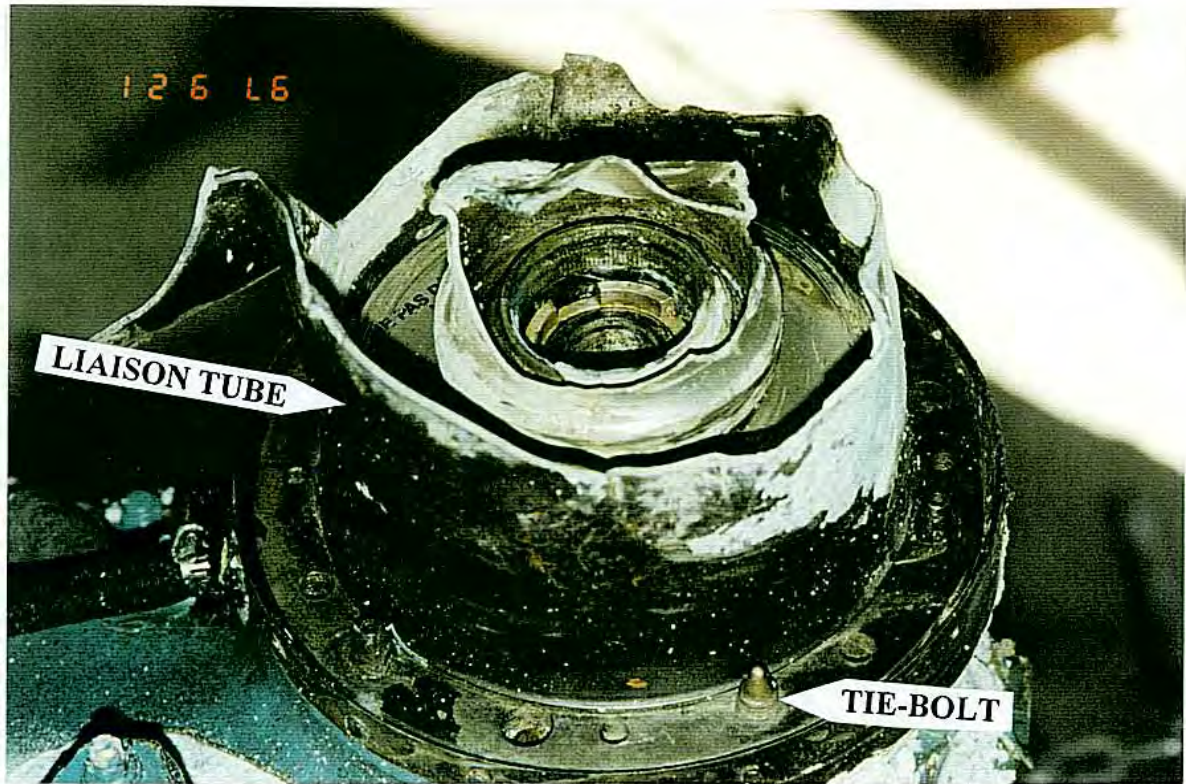

R/H INPUT



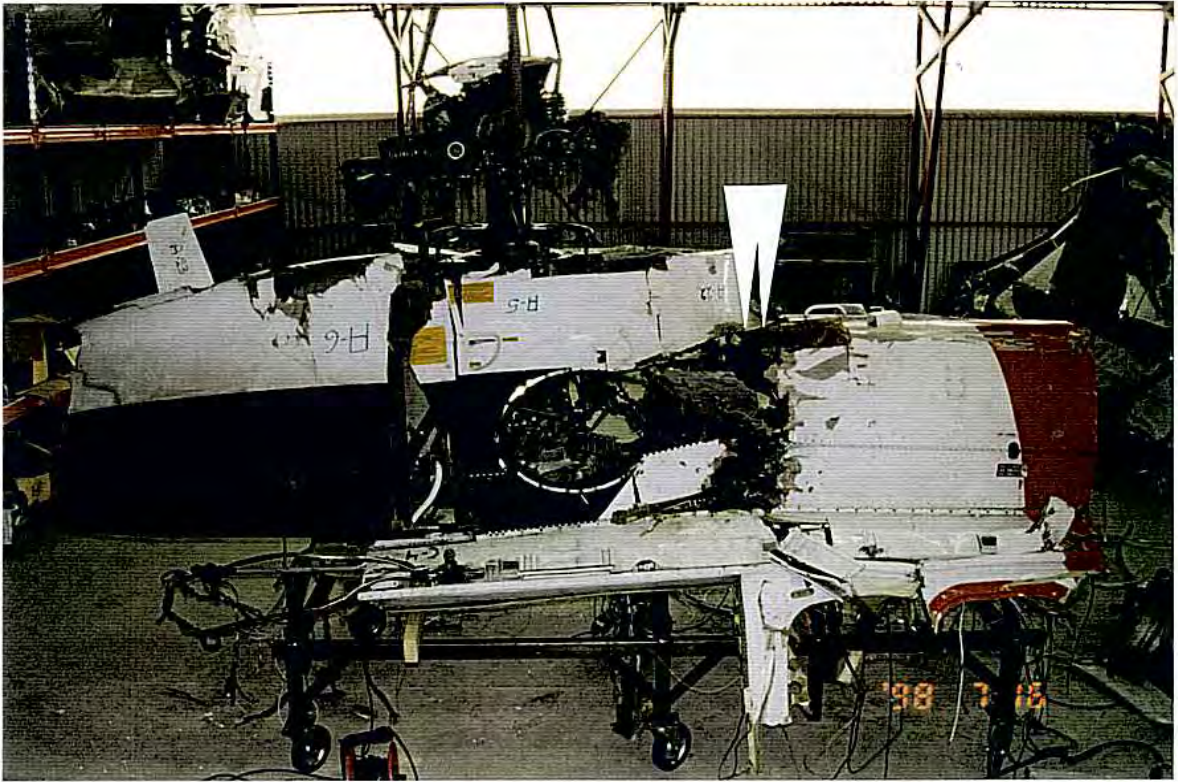

RECONSTRUCTION R/H SIDE

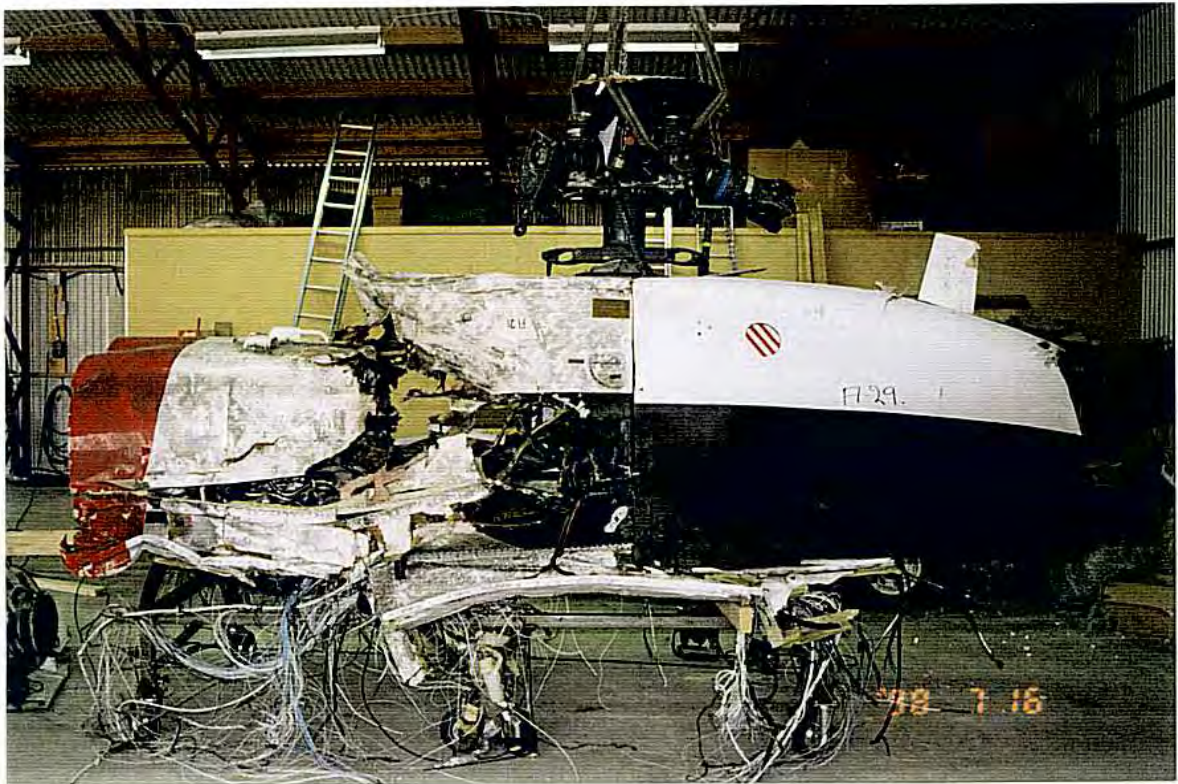

RECONSTRUCTION L/H SIDE

Fig. 20

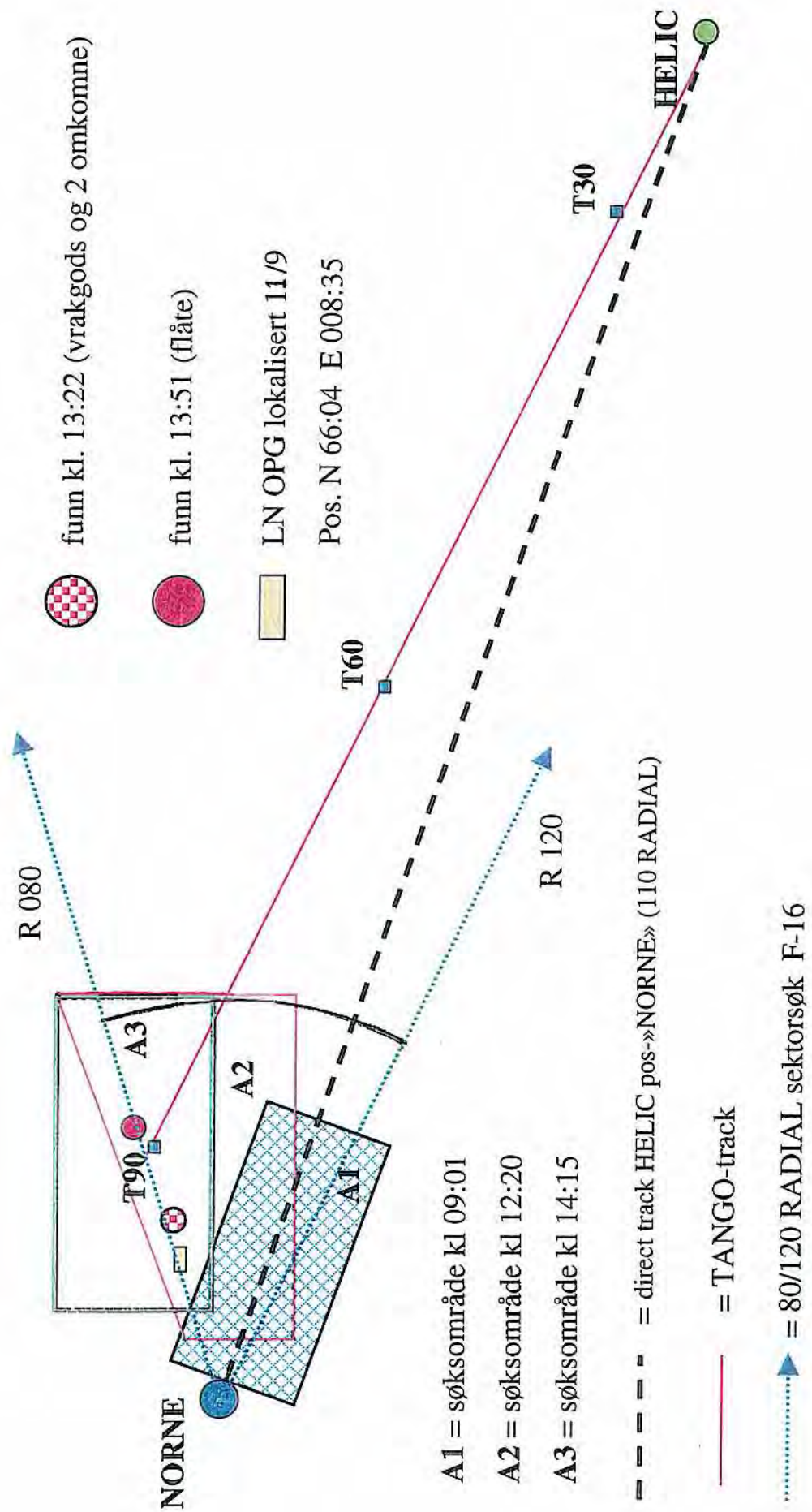



Side view (profile) of the front end retaining nut, the failed splined sleeve and the MGB R/H side input shaft assembly. The positions of the broken attachment lugs on the bearing retainer are arrowed.

Fig. 21

Report No. 98-1118, rev. 02

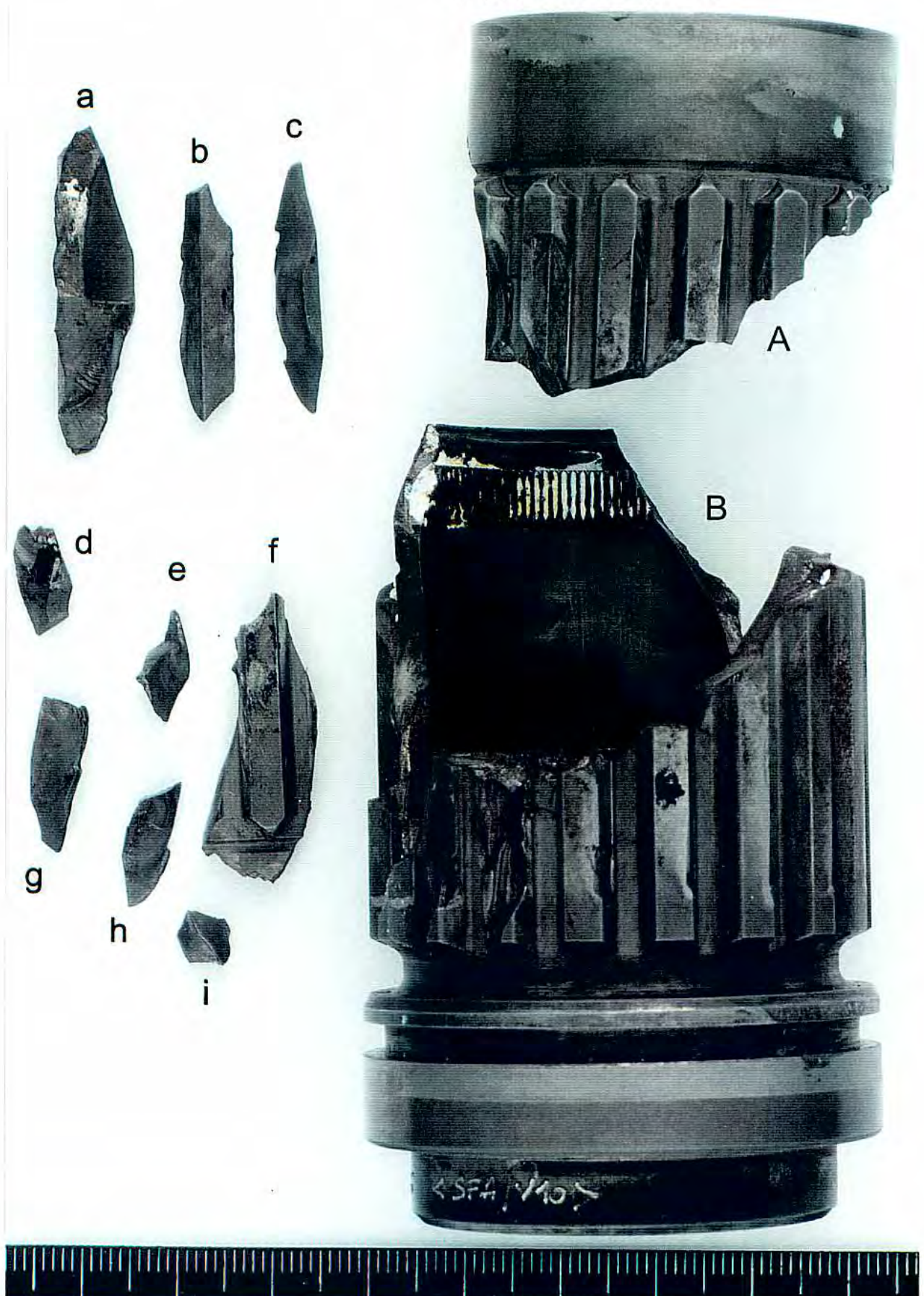

General view of the first received sections of the failed splined sleeve. Two large sections "A" and "B", and nine smaller sections "a" - "i" are shown.

Report No. 98-1118, rev. 02

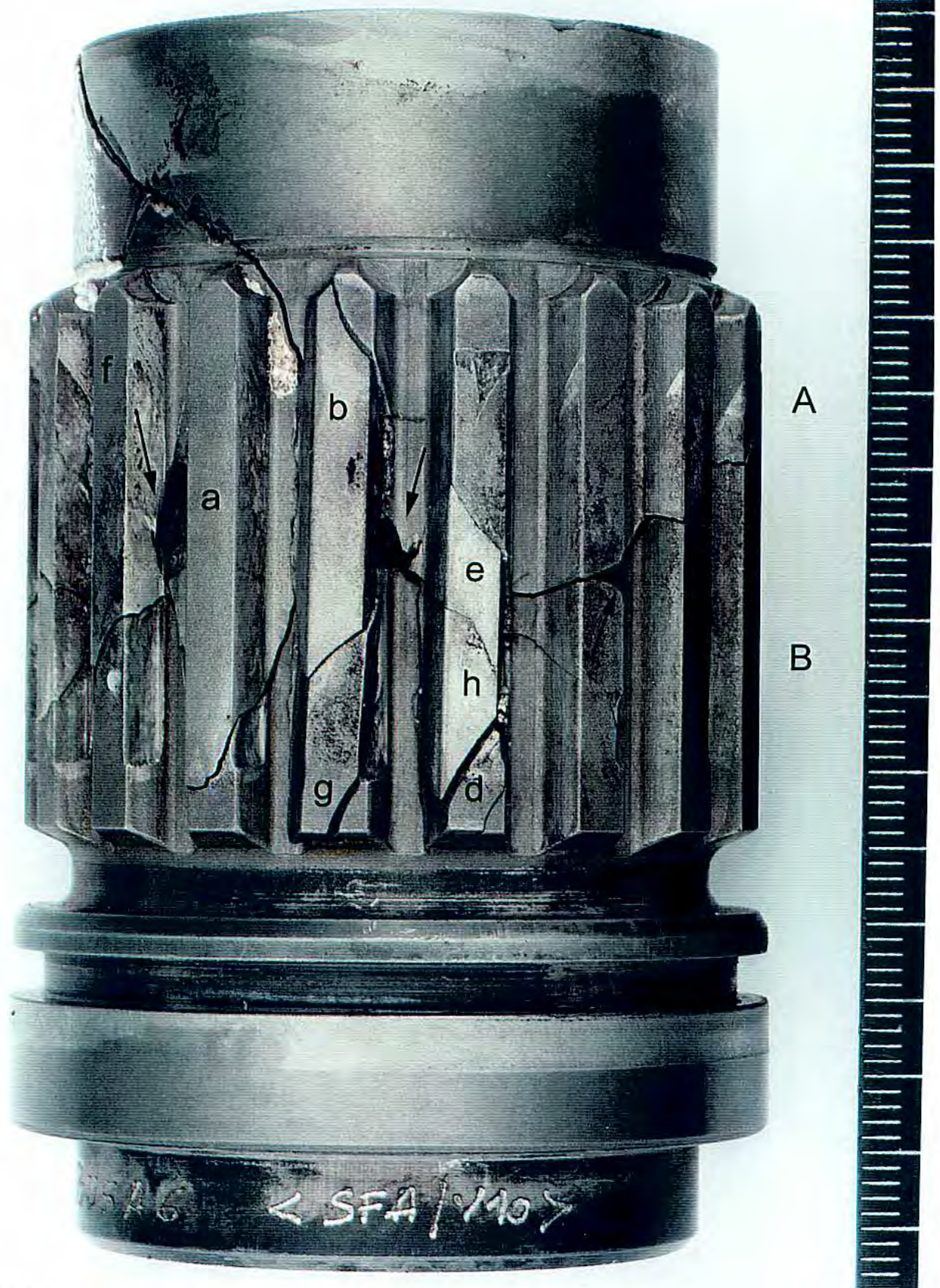

Same "side" appearance of the failed sleeve sections ("a" - "b" and "d" - "h", missing sections are arrowed.

with also seven of the smaller in place. The locations of three very small



Appearance of the same "side" of the failed sleeve as shown in sections "j" and "k", that were received later, now in place.

with

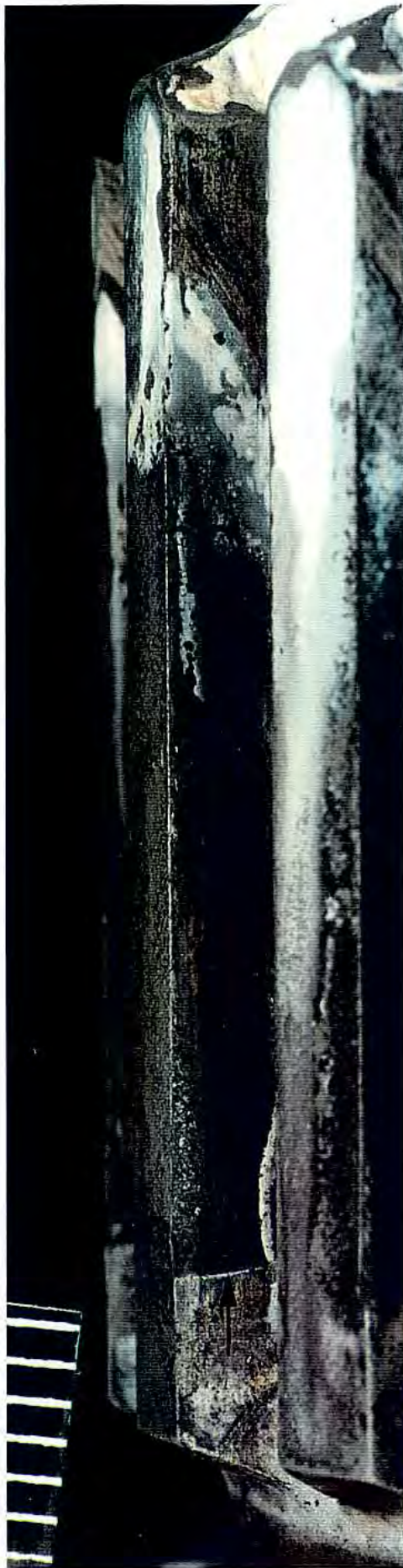

AFT

FWD



A general view of two active flank surfaces. Though partly covered by a white surface deposit, an oblique load condition for both flanks is indicated, with a maximum herzian load towards the left end of the engagement. (Flanks of the tooth No. 12 (top) and No. 1 and 2 (below) are arrowed).

R/H MAIN GEARBOX INPUT SHAFT SPLINED SLEEVE

Report No. 98-1118, rev. 02

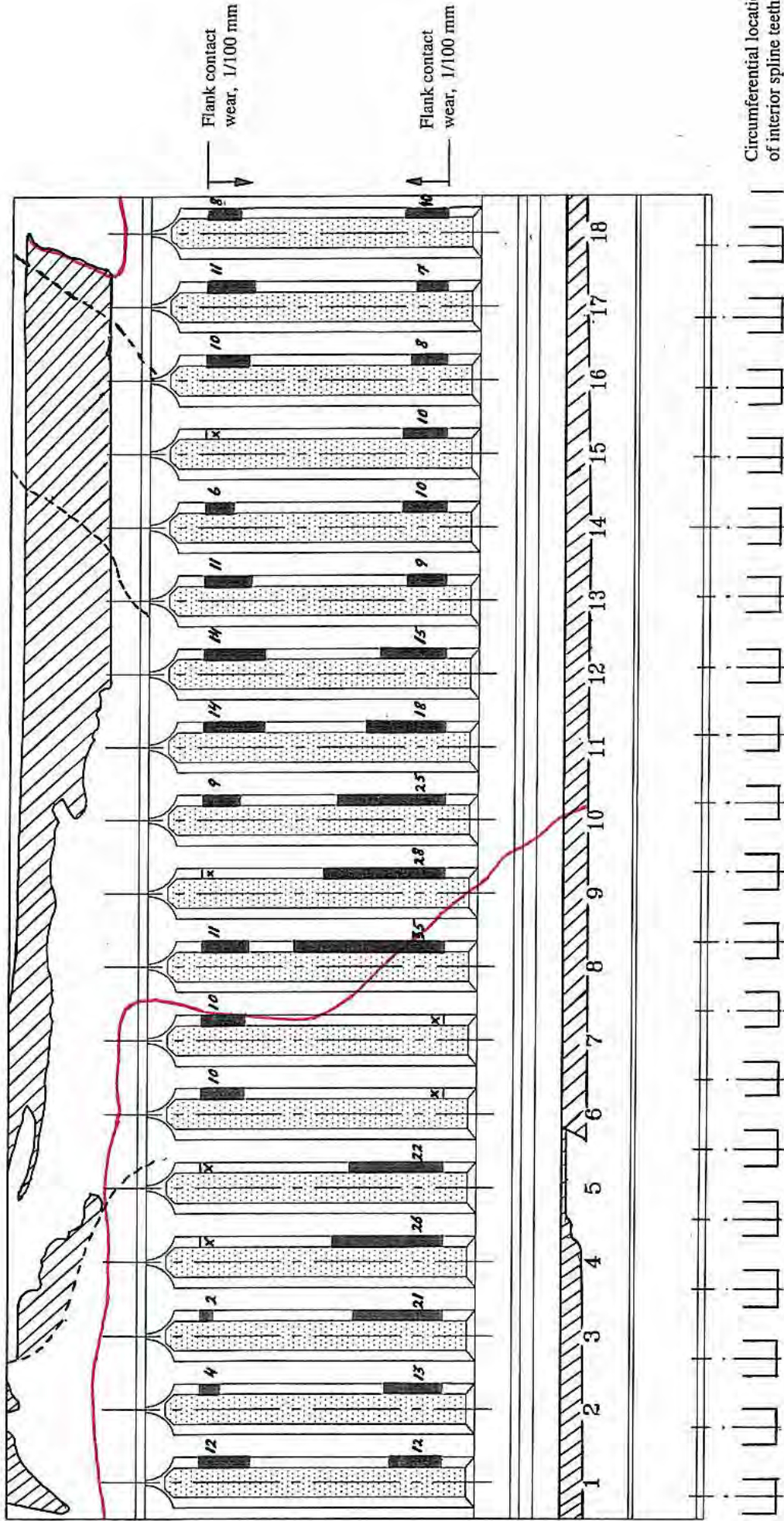

Recording of flank wear and end section fretting corrosion / surface battering.

— Crack from splined flange mirrored onto splined sleeve

Fig. 26

Report No. 98-1118, rev. 02



Close-up view of the splined rim close to the front end of the failed sleeve (front surface seen at the top of the photo). Deformation of the forward section of the spline teeth, and also some regular indentation marks close to the front surface, are noted.

Report No. 98-1118, rev. 02



General view of the front end lock washer and its locking ring. The side surfaces of the four engagement claws had suffered deformation/indentation due to rotational contact wear. Two of these locations are arrowed.

Report No. 98-1118, rev. 02

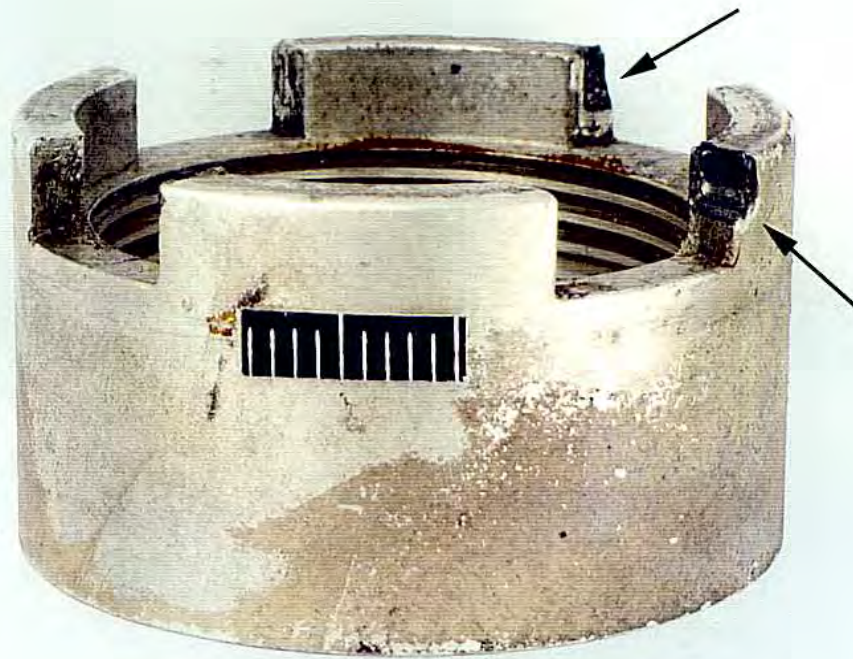

General view of the front end retaining nut, after a controlled torque disengagement from the MGB input shaft. The two locations arrowed on this photo clearly confirm a rotational contact wear towards the mating claws of the lock washer.

Fig. 30



Fig. 31

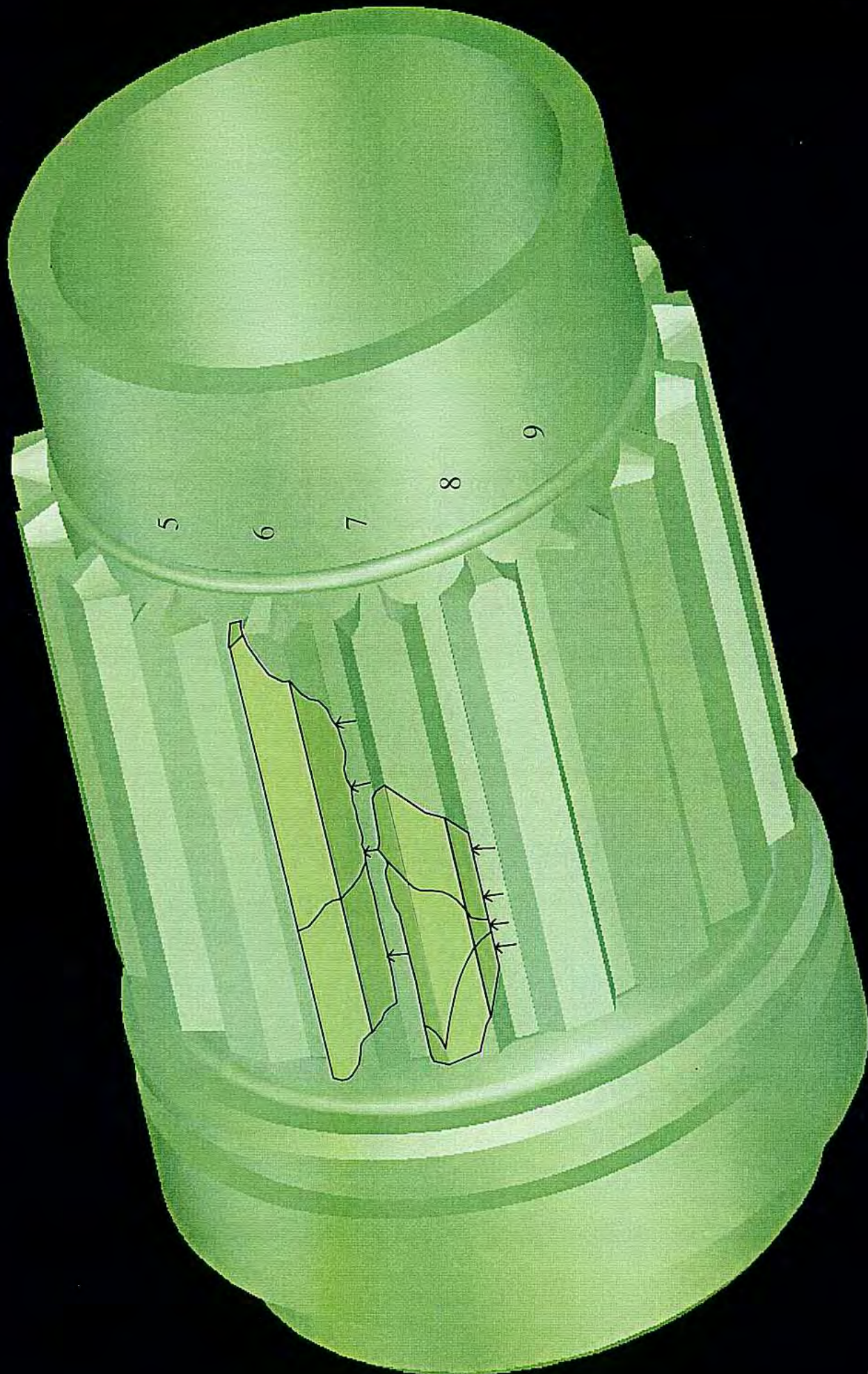

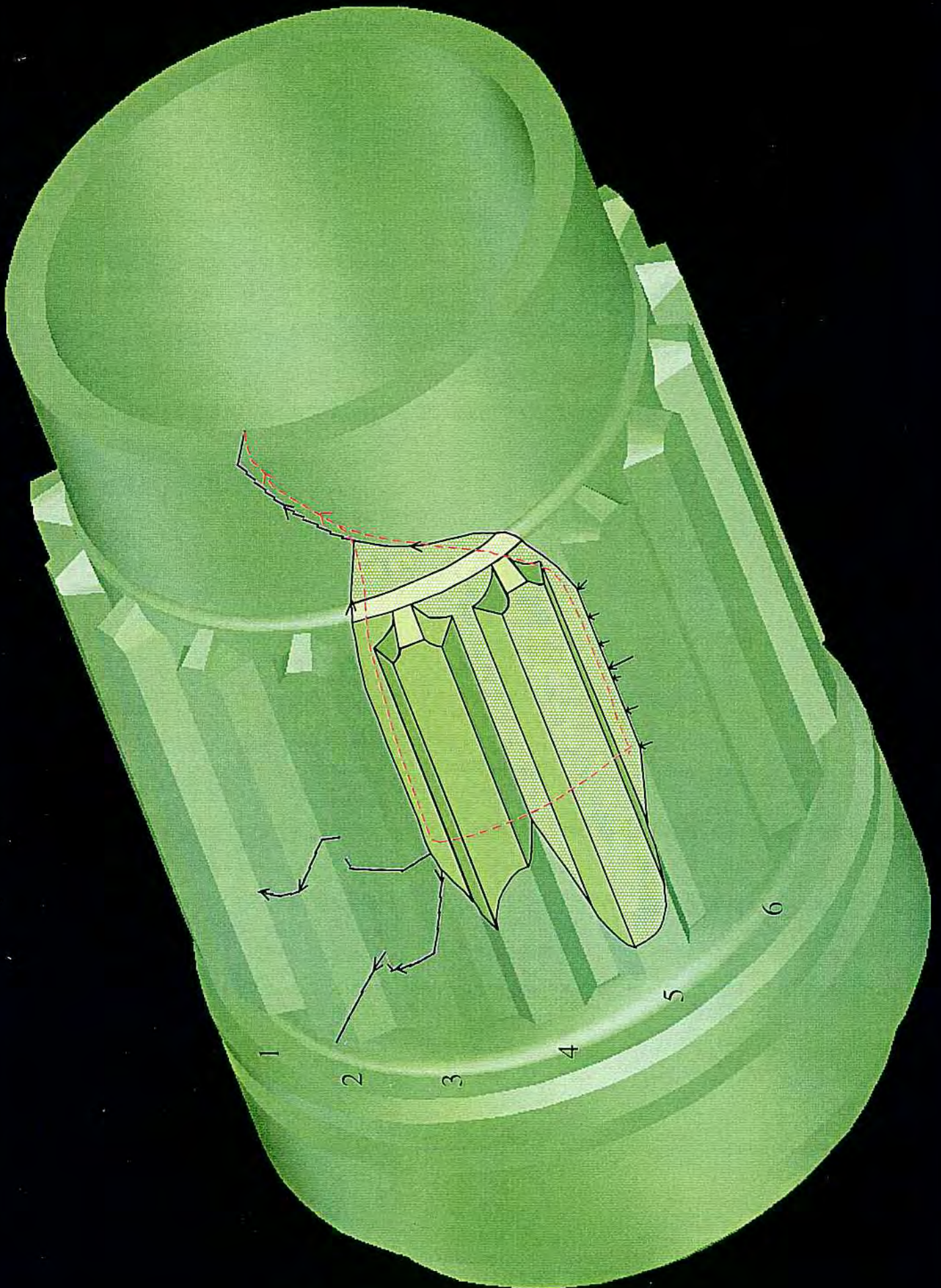

Following sequence I of failure

R/H MAIN GEARBOX INPUT SHAFT SPLINED SLEEVE

Report No. 98-1118, rev. 02

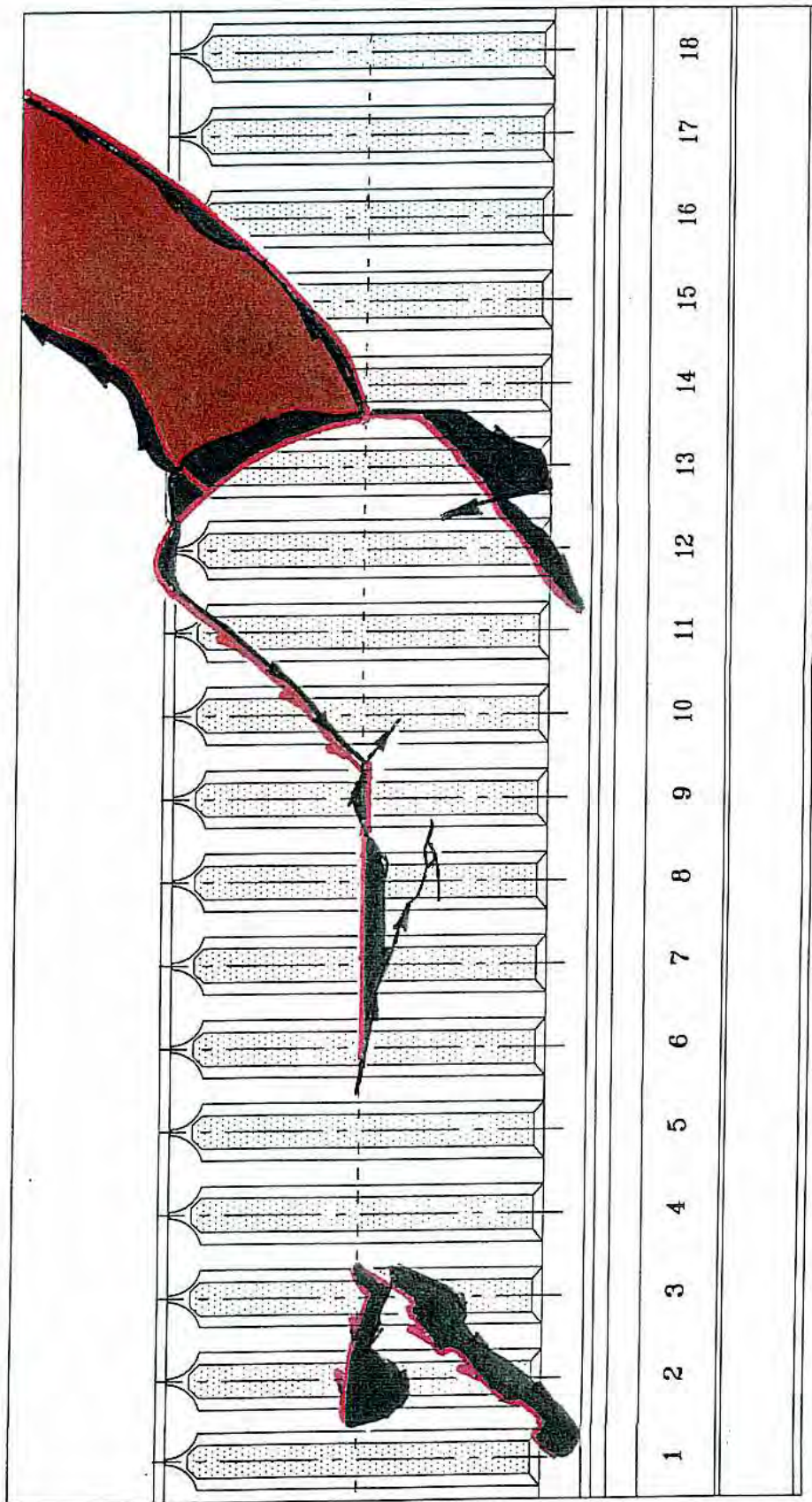

Following sequence II of failure

- Shaded area: Fatigue crack surfaces leading to fracture.
- Location of arrows: Starting from the crack initiation areas.
- Number of arrows: The total number of initiation areas for each tooth fracture.
- Direction of arrows: The direction of fatigue crack propagation.
- Dark line with arrows: Crack location, exterior surface.
- Red line with arrows: Crack location, interior surface.
- Dark red area: Interior surface being part of longer tooth fragments.
- Dark green area: Crack surface through the wall thickness of the sleeve.

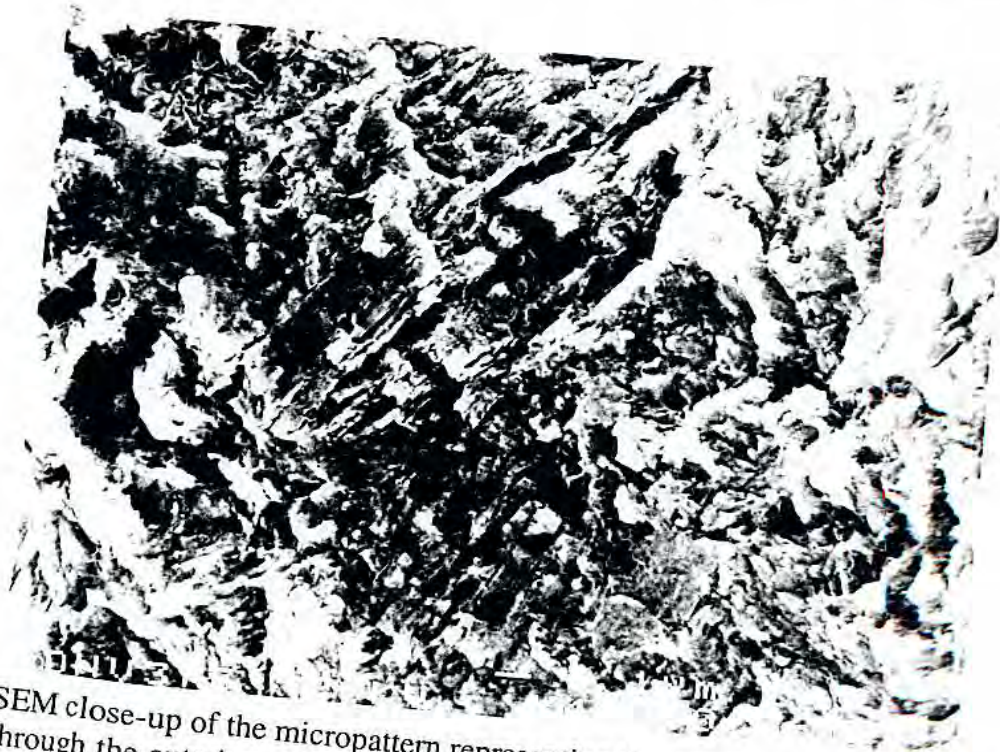

SEM close-up of the micropattern representing the transverse crack propagation through the exterior spline tooth No. 6. The presence of fatigue striations is stated. Magnification X 4000.

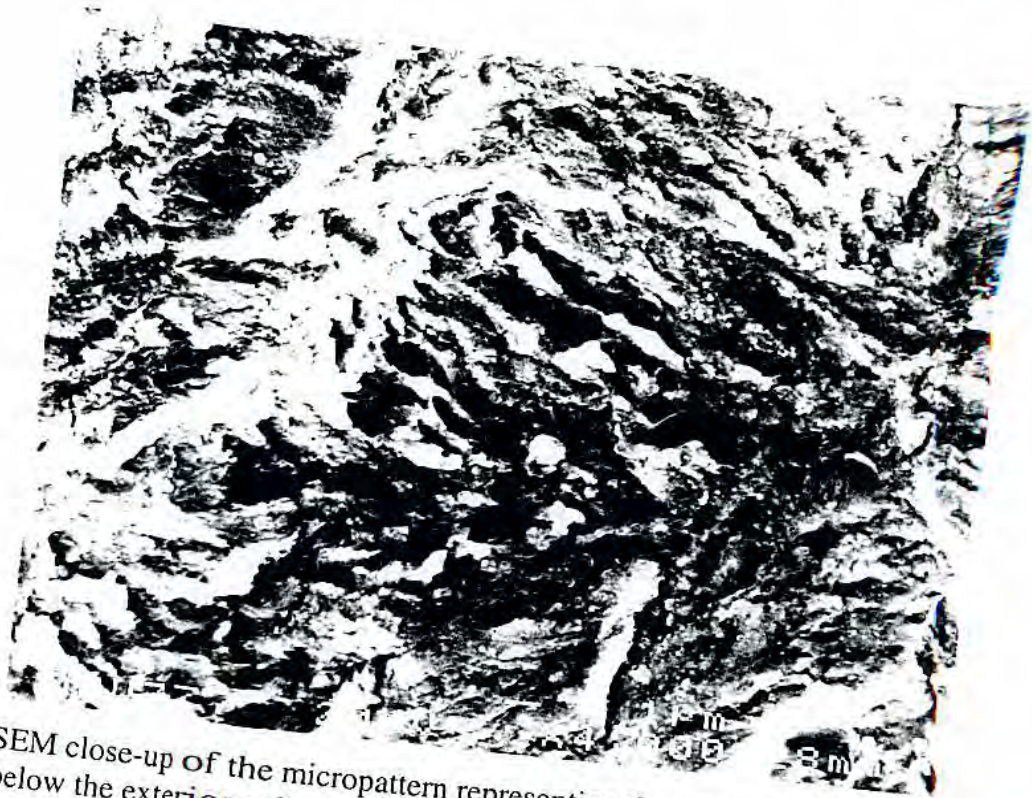

SEM close-up of the micropattern representing the tangential crack propagation below the exterior spline tooth No. 6. Also this local tooth breakage is confirmed to be a consequence of fatigue crack propagation. Magnification X 4000.

Report No. 98-1118, rev. 02

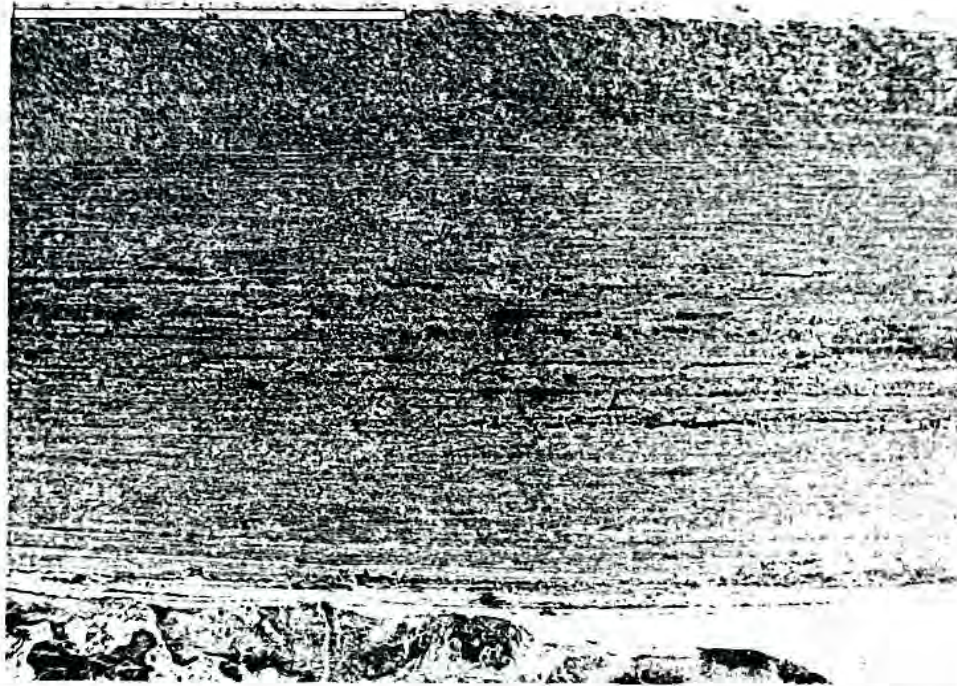

SEM-view of the inactive flank surface for the exterior spline tooth No. 6. The longitudinally directed pattern of dark lines found in the hardmetal coating was recorded both within and outside the contact area of the flank. Magnification X 25.

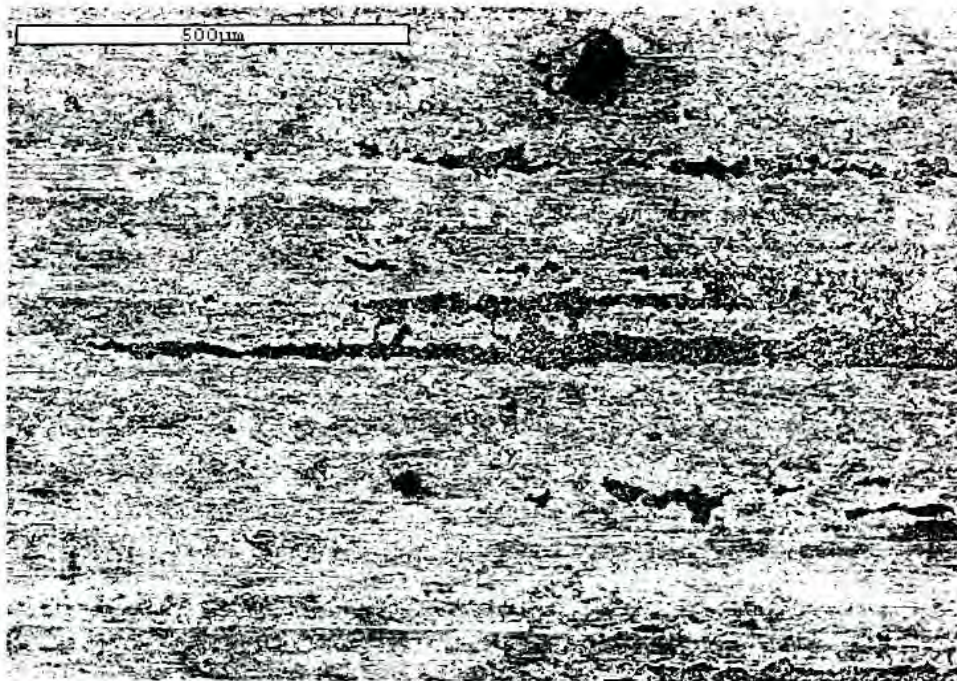

A closer SEM-view of the pattern of dark lines shown. Some process of longitudinal scoring and local tear of the hardmetal coating is indicated. Magnification X 100.

Report No. 98-1118, rev. 02

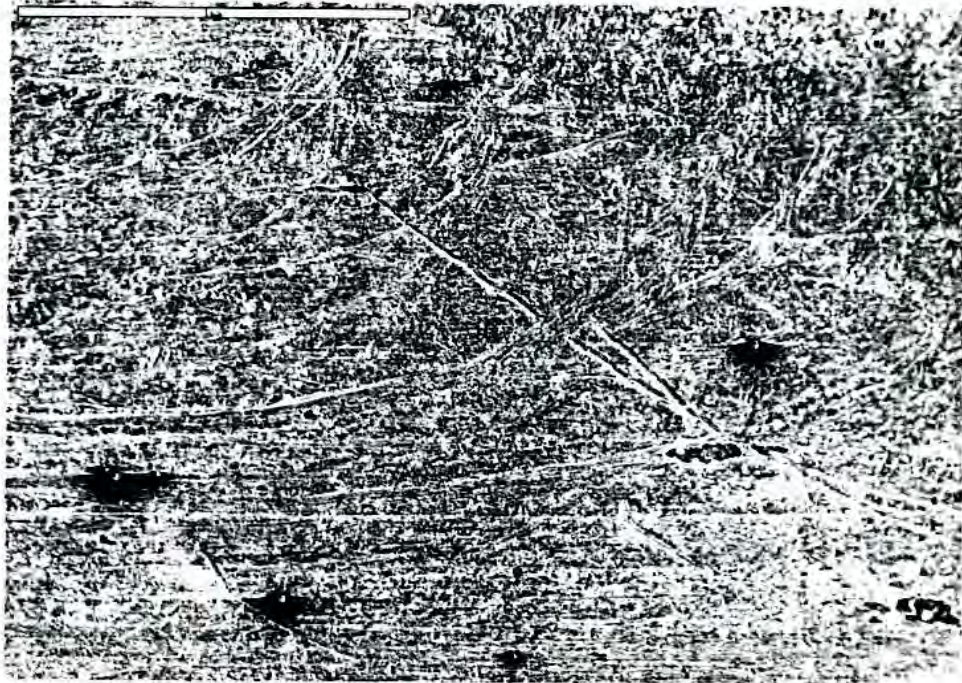

SEM-view of the end section of some of the mechanical scratches/scores, seen on the hardmetal coated inactive flank of the exterior spline, tooth No. 6. Magnification X 50.



SEM detail of the pattern of mechanical scratches/scores on the tooth No. 6 inactive flank surface.

Magnification X 300.

Report No. 98-1118, rev. 02

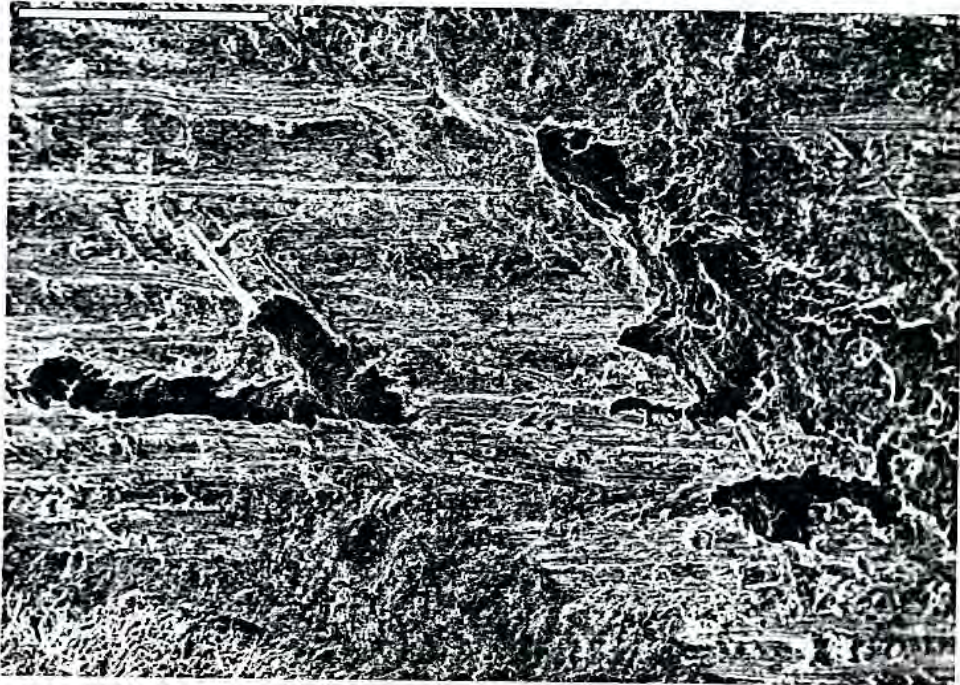

Another SEM-view representing the pattern of mechanical scratches/scores on the hardmetal coated inactive flank, tooth No. 6. The connection between local surface contact and missing hardmetal coating is found further documented. Magnification X 160.



SEM close-up, illustrating that the mechanical scratches/scores are responsible also for a local surface "smearing" and transverse cracking of the hardmetal coating. Exterior spline, tooth No. 6, inactive flank. Magnification X 1000.

Report No. 98-1118, rev. 02

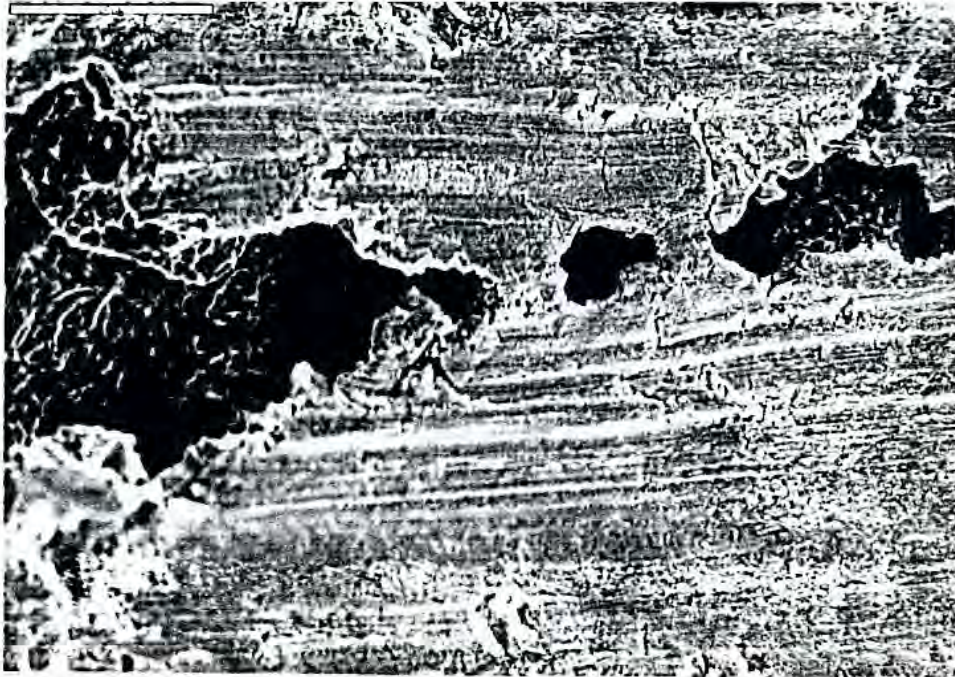

SEM close-up, showing a significant pit formation (cavity) below a "smeared" surface material. Exterior spline, tooth No. 6, inactive flank. Magnification X 1375.

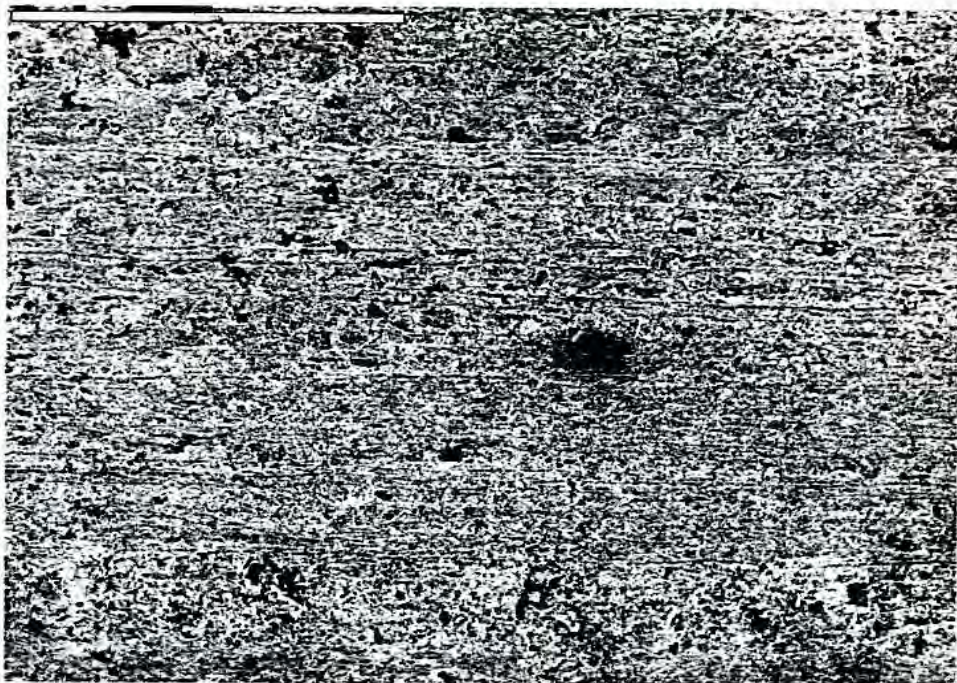

SEM-view of the hardmetal coated base (root) surface, adjacent to the exterior spline, tooth No. 6. Numerous surface pits (cavities) and a pattern of longitudinal surface wear are noted. Magnification X 100.

Report No. 98-1118, rev. 02

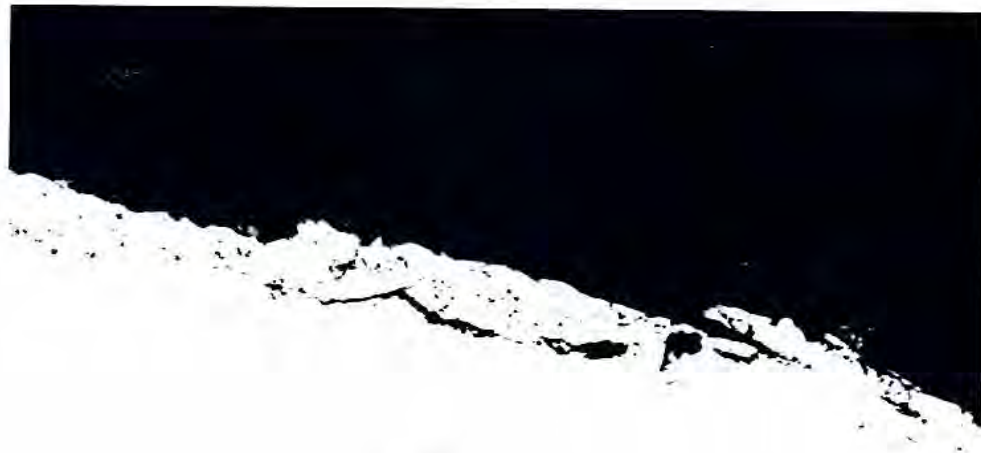

6

Transverse, metallographic section through the hardmetal coating of the inactive flank.
Lamination of the coating is seen. Magnification X 500.

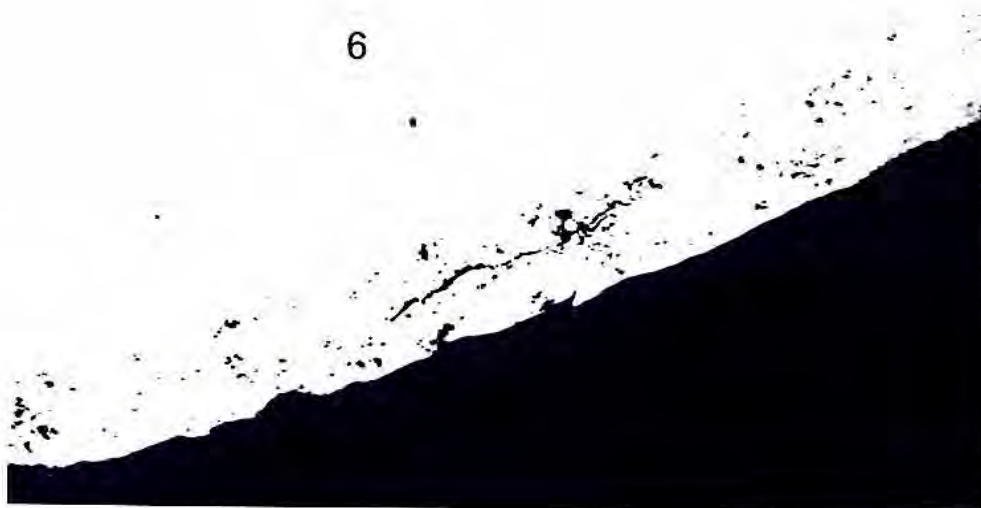

6

Another metallographic section through an intact surface location.
An indication of some lamination of the hardmetal coating is seen. Magnification X 500.

Report No. 98-1118, rev. 02



Transverse section through a location of hardmetal coating on the exterior spline, tooth No. 6. The steel section is darkened so that only the coating is seen. Magnification X 2100.



Close-up view of a tungsten carbide particle found to cover almost the full depth (thickness) of the hardmetal coating. The particle in question is arrowed. Tooth No. 6, inactive flank location. Magnification X 1000.

Report No. 98-1118, rev. 02



Transverse, metallographic section through the active flank of the tooth No. 6, at a location of fracture initiation close to the base (root) area. Numerous narrow cracks, parallel to the one leading to fracture, are seen. Magnification X 500.

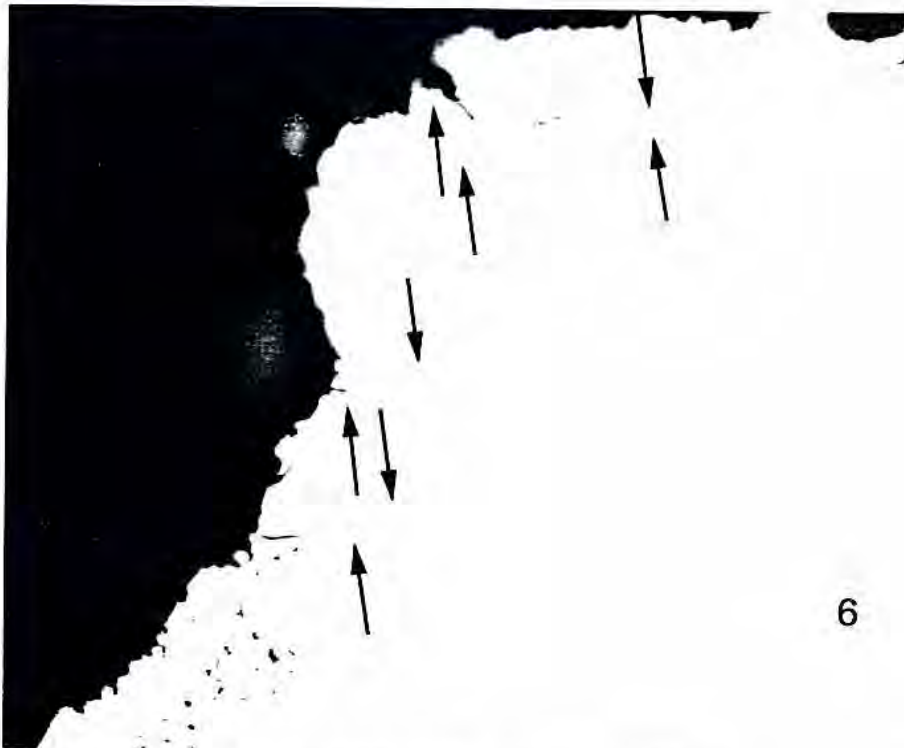

Close-up view of the most interesting zone of cracking. The cracks found are arrowed on this photo. Magnification X 1000.

The cracks



General view of the two power transmission shafts (Bendix shafts) from the Super Puma LN-OPG. The intact shaft seen to the left belongs to the L/H power transmission system (PTS) of the helicopter.

Report No. 98-1276

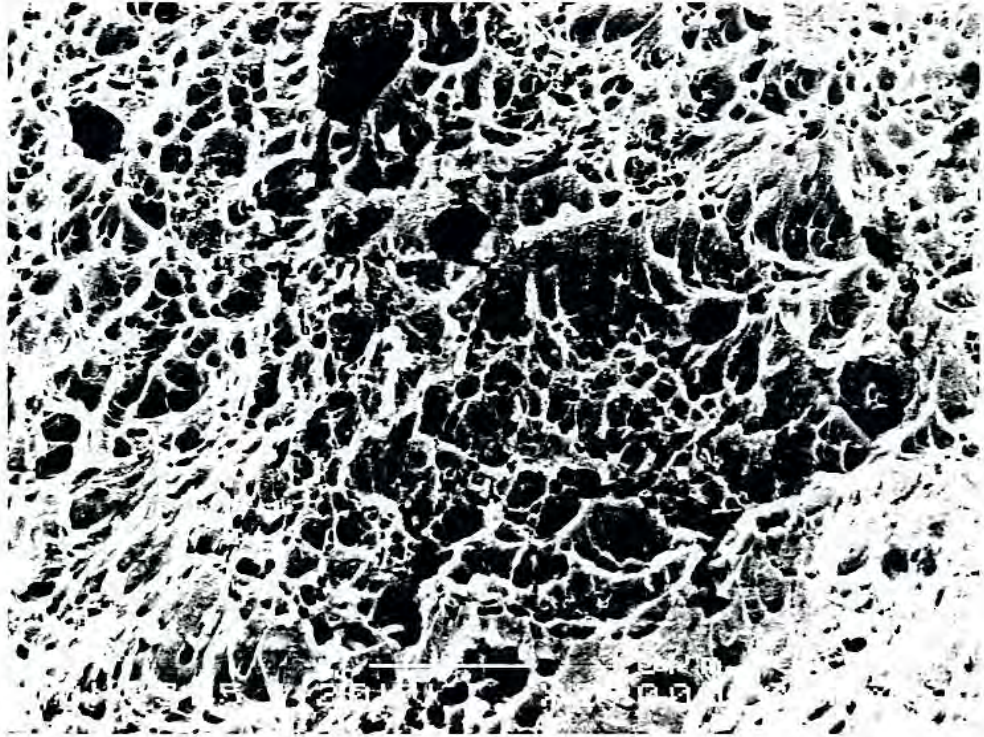

SEM micropattern representing the fracture location "B" of the thin-walled tubular shaft. Characteristic dimples are seen.
Magnification X 2000

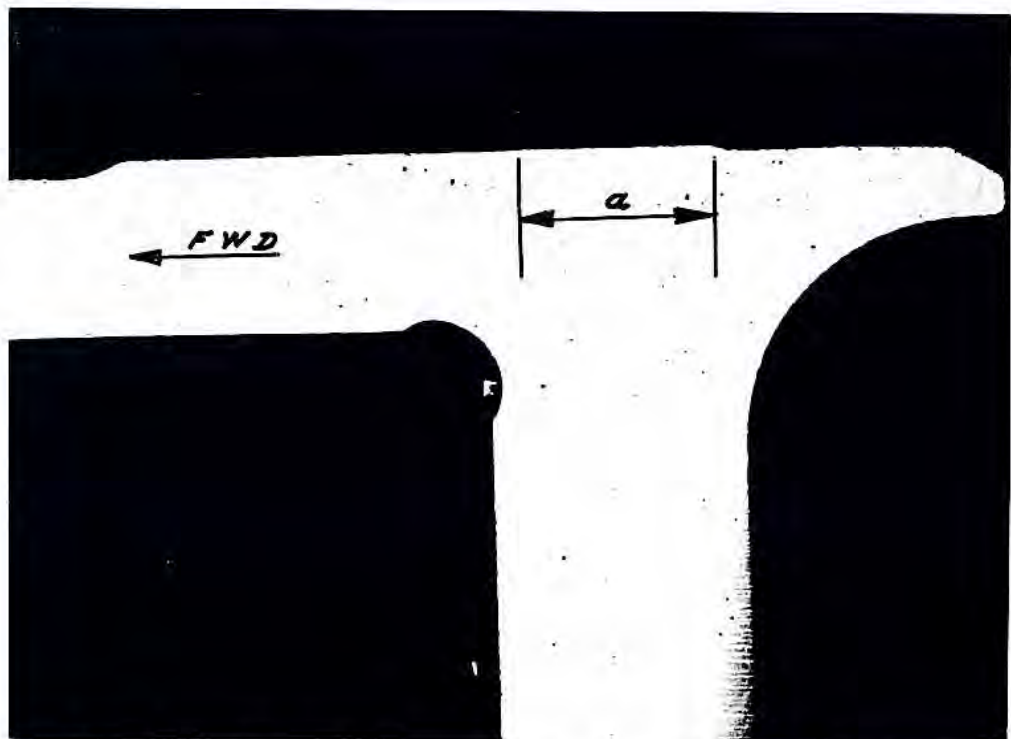

Axial metallographic section through the rear end of the flange unit. The interior cylindric surface is seen at the top of the photo.
Magnification X 12.



SPLINED FLANGE

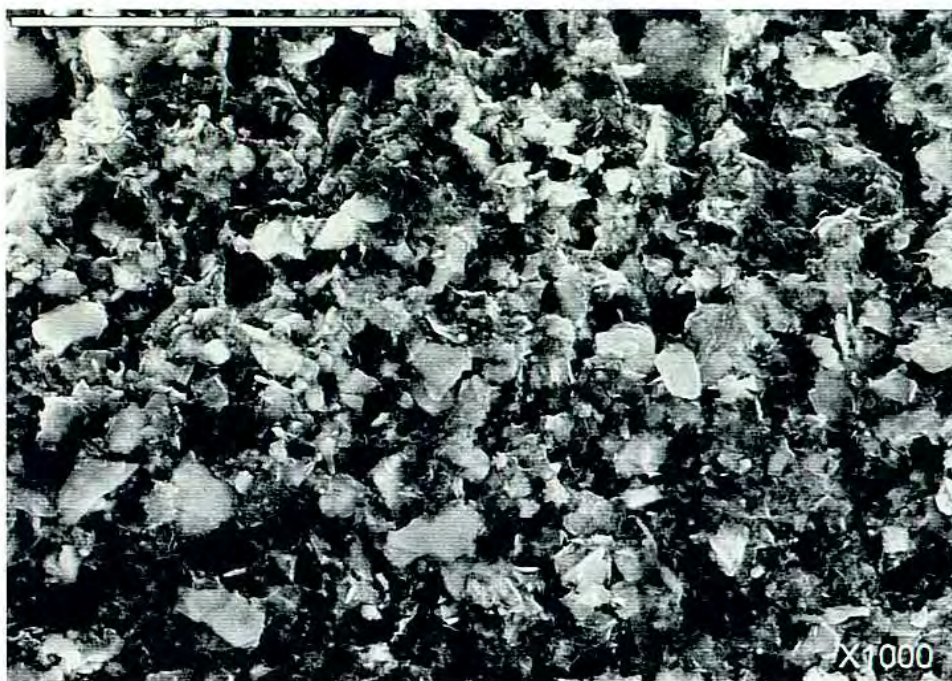

SEM-photo showing the surface of the rather hard deposit found on the base surfaces between the interior spline teeth.
Magnification X 1000.

Report No. 98-1276

↑
FWD

Another side view of the Bendix shaft end flange after disassembling from the tubular shaft section. The distinct crack formation can be followed all the way down to the rear end of the flange. At some locations a branched cracking is also noted.

BENDIX SHAFT SPLINED END FLANGE

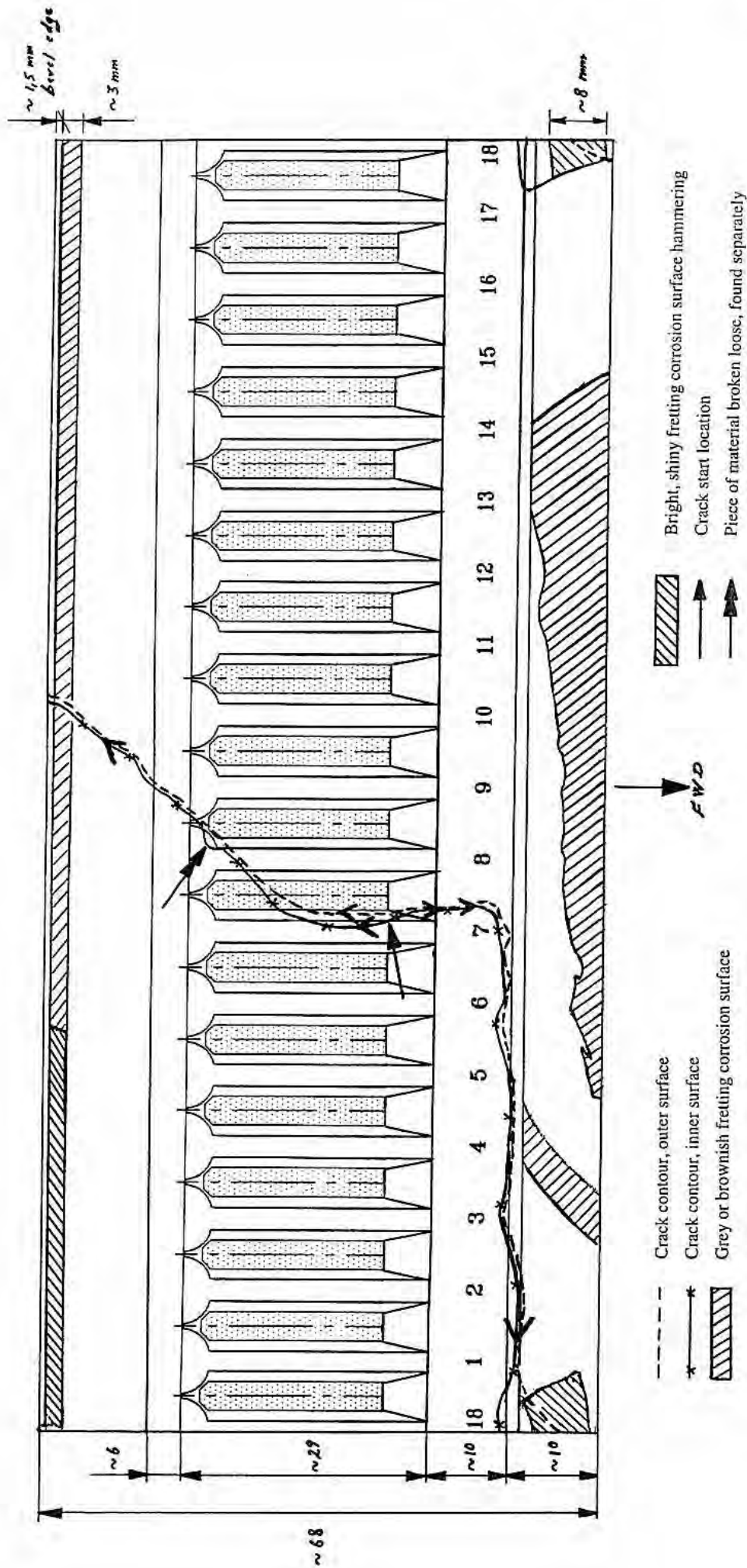

Sketch illustrating the crack geometry and mechanical contact wear for the interior surface of the end flange unit. The interval numbers seen on the sketch corresponds to the teeth numbers of the failed splined sleeve. (Ref DNV-report no. 98-1118).

Report No. 98-1276

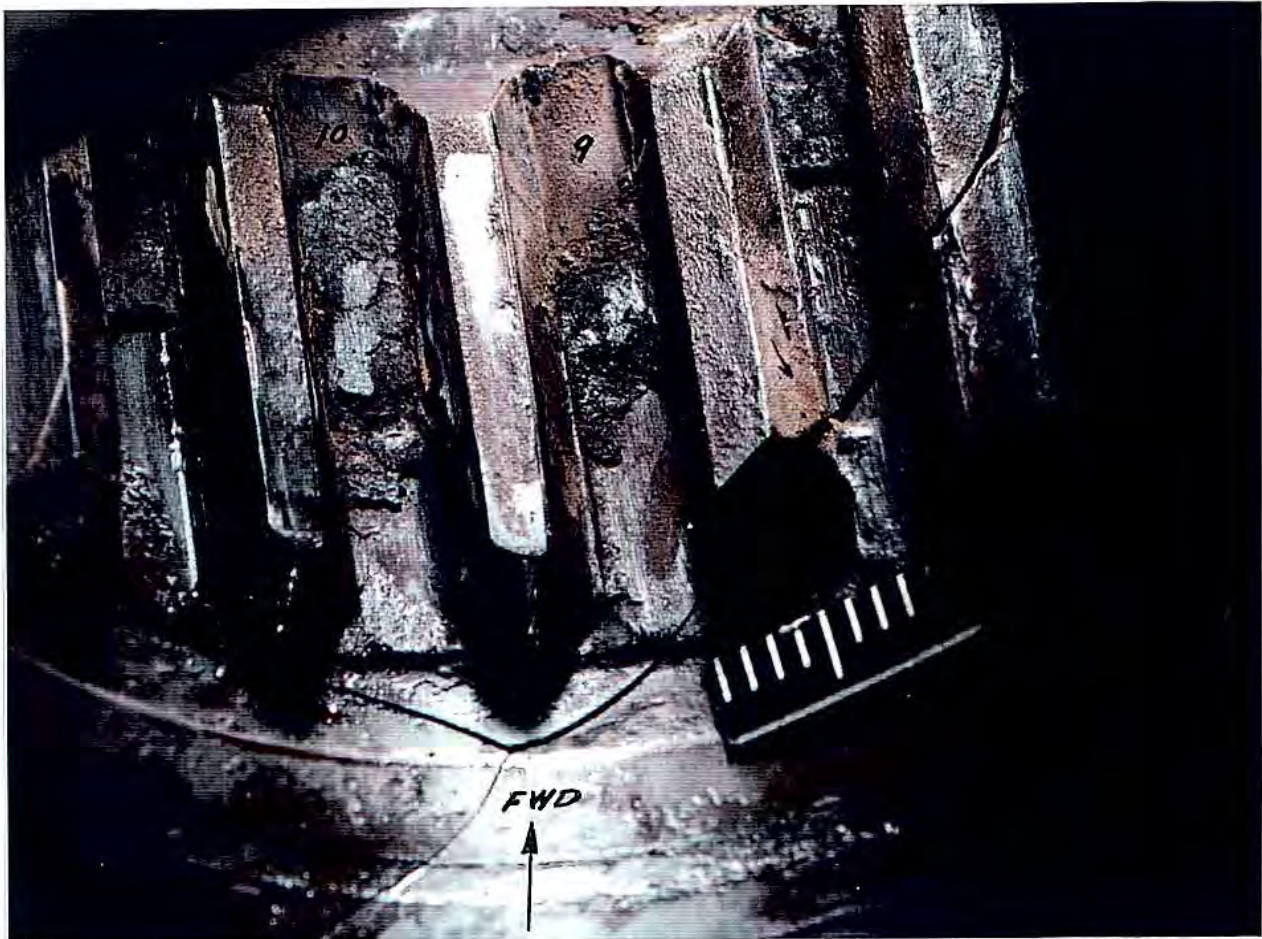

Interior view of the splined portion of the end flange unit, covering the sector from interval No. 11 (left) to the interval No. 8 (right), referring to the identification of the outer spline teeth of the sleeve.



Close-up photo of the indicated crack start location of the splined end, in the condition "as received", i.e. covered by a white deposit. The location is found at interval No. 7.

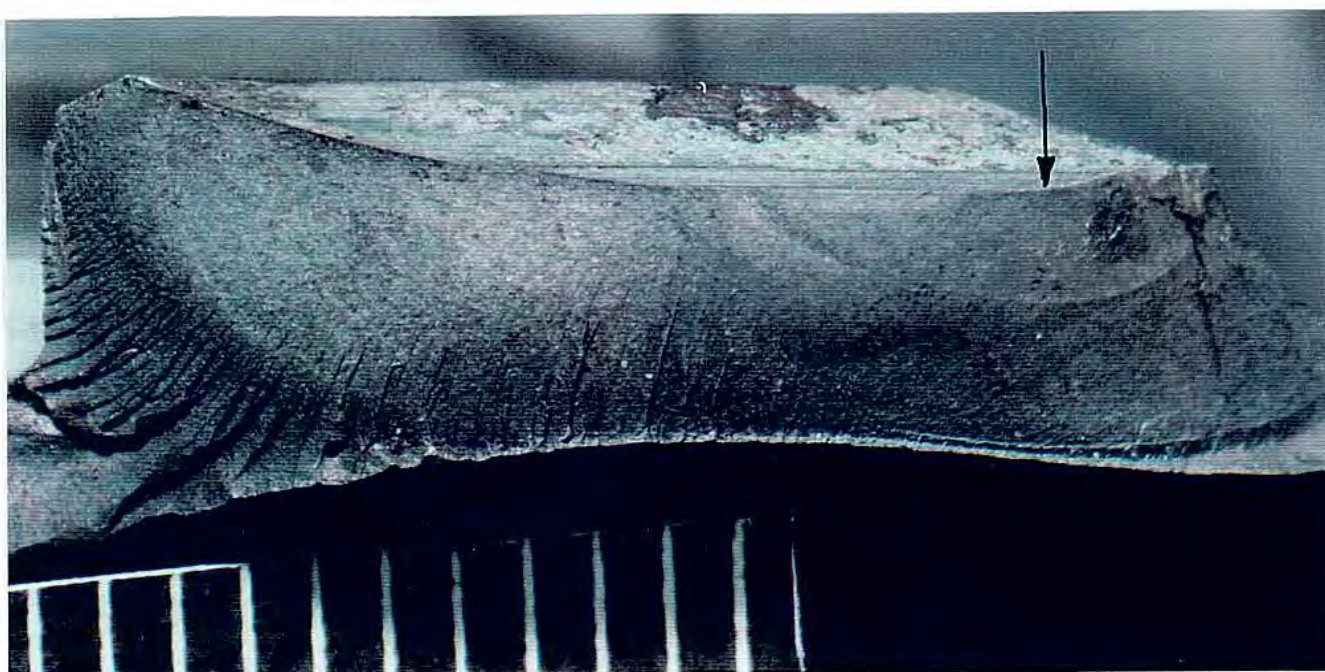

Same location seen after an ordinary chemical cleaning. The indicated crack start location is seen arrowed on the photo.

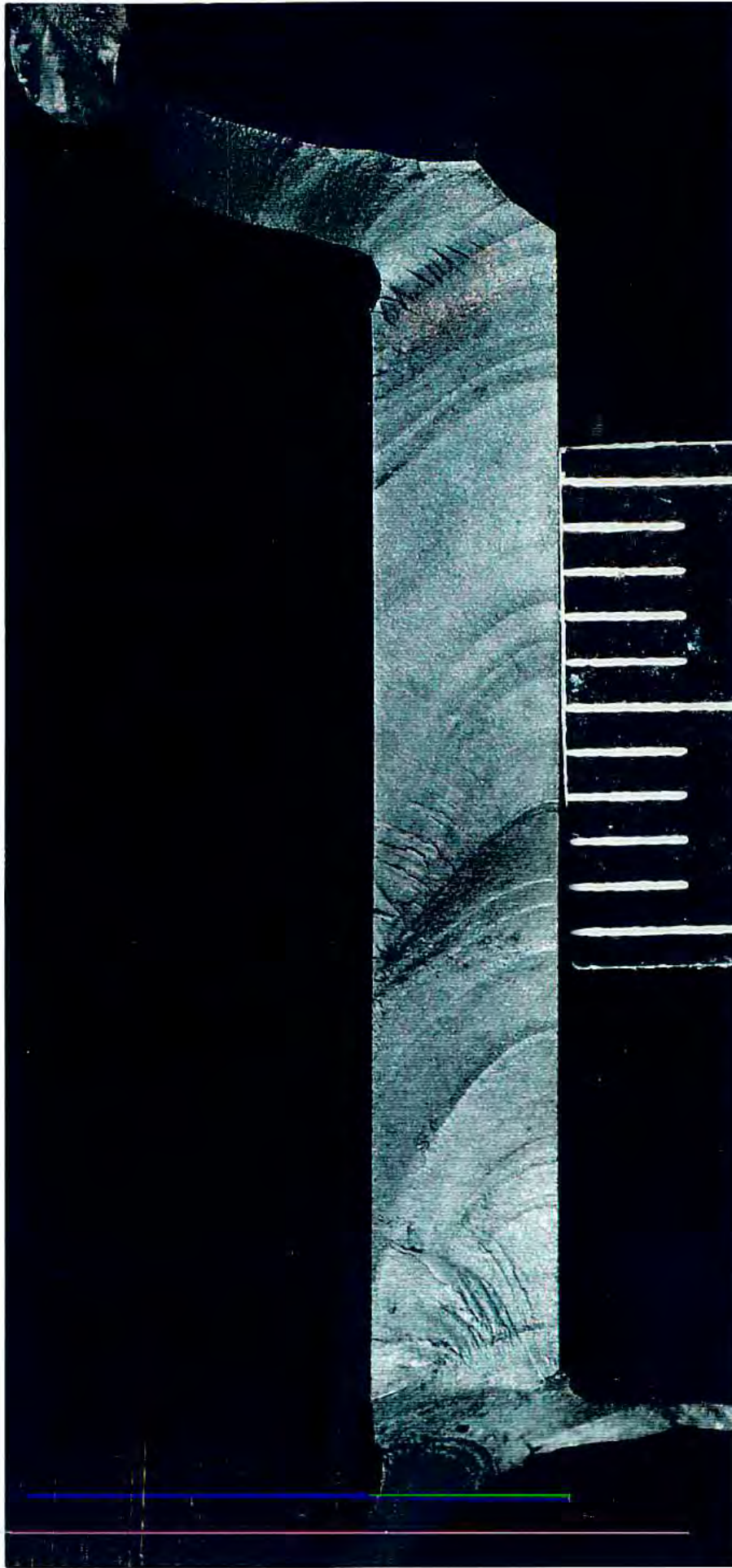

Close-up photo showing the crack surface in the rear section of the end flange unit (i.e. through the flange and the end flange collar, towards the location arrowed in the right, upper corner).

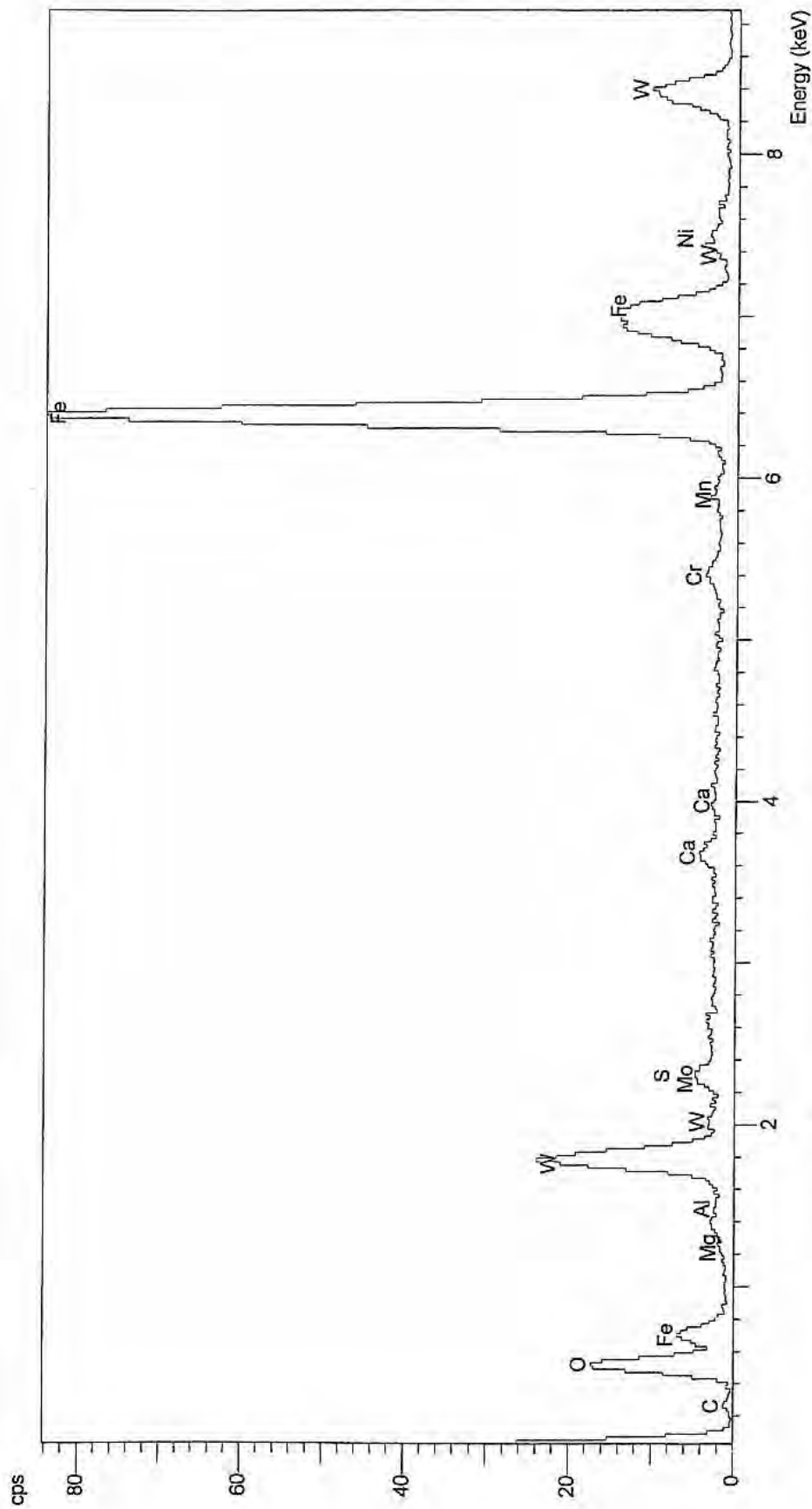

EDS analysis diagram, representing mainly ferrous (Fe) and tungsten (W) based particles found in the interior spline deposit.

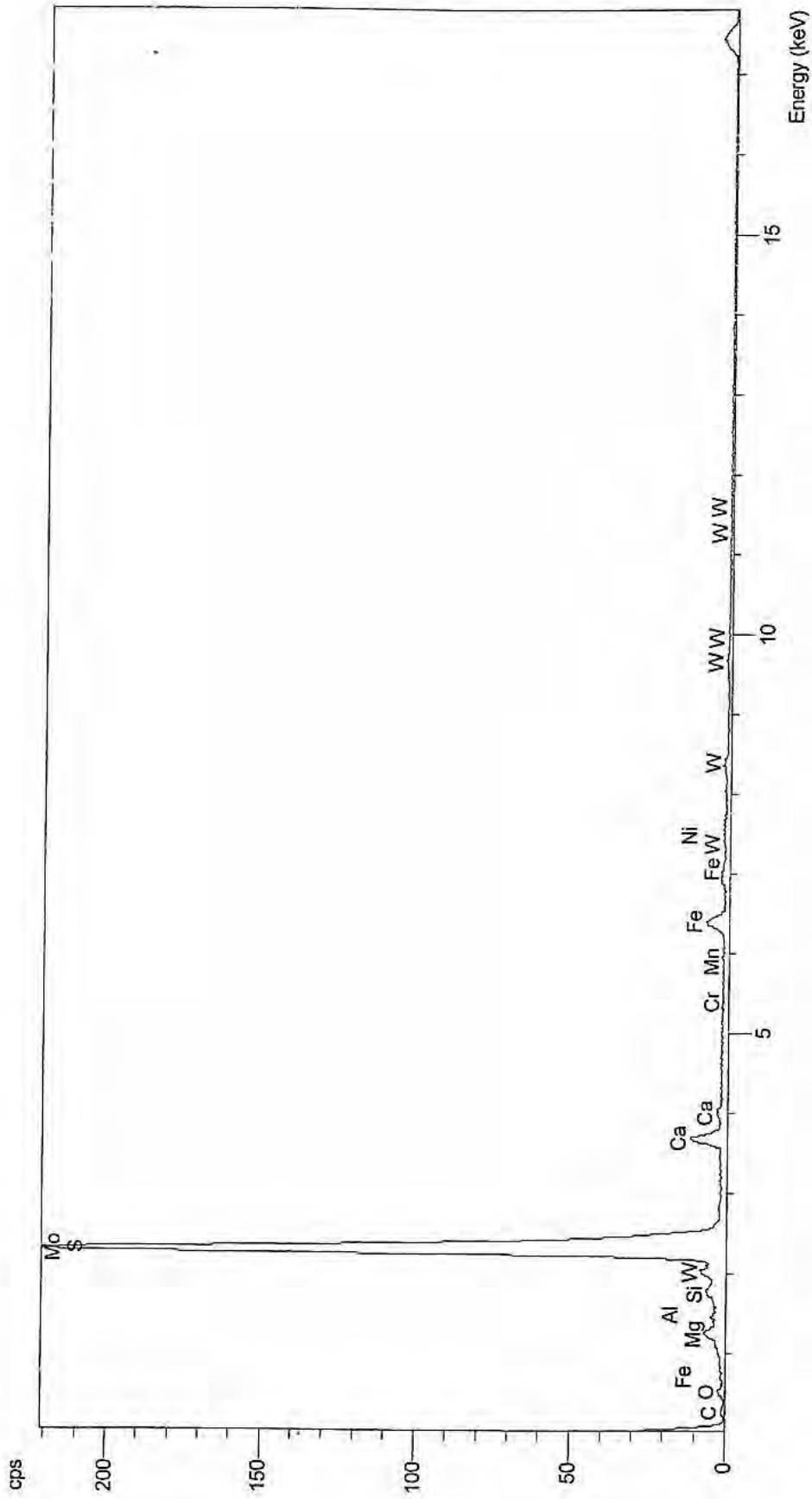

EDS analysis diagram, representing mainly molybdenum (Mo) based particles and sulphur (S) concentrated constituents found in the interior spline deposit.

LN-OPG

Plot av avganger fra 24. august til 8. september.

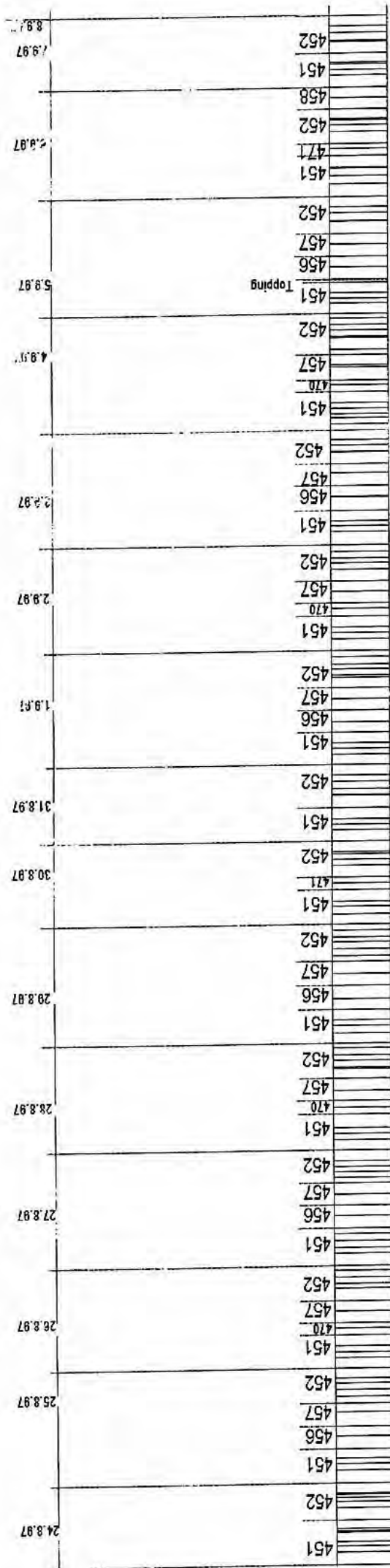

Tidsakse, (original en mm = ett minutt flytid/dekkid).



Fig. 52

Havarikommisjonen
for sivil luftfart
14 NOV. 1997

Arkiv:

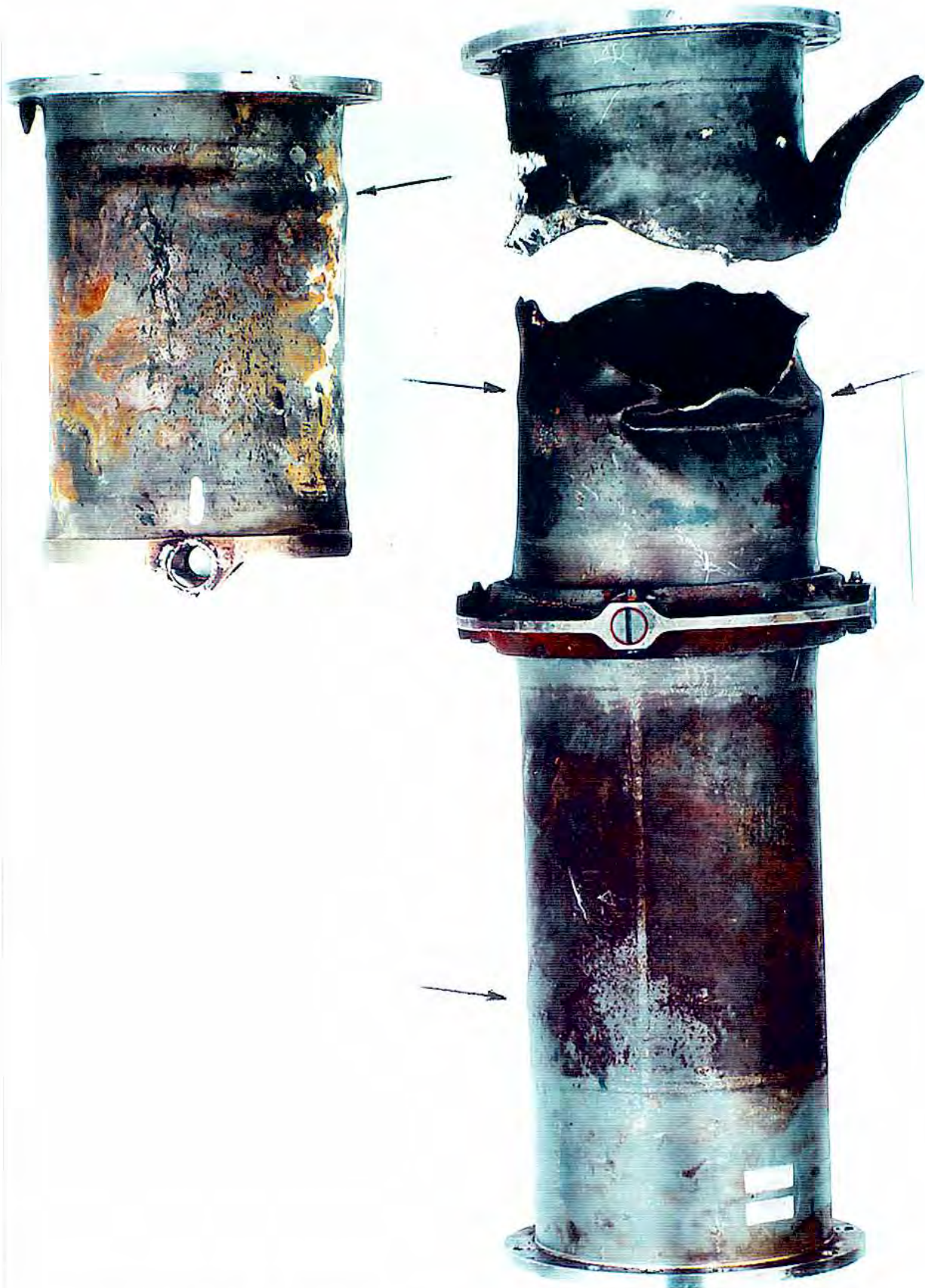

Close-up photo of the fractured R/H Liaison tube assembly (right), together with the AFT half-tube from the corresponding L/H assembly. Some exterior bulges (protrusions) are seen arrowed.

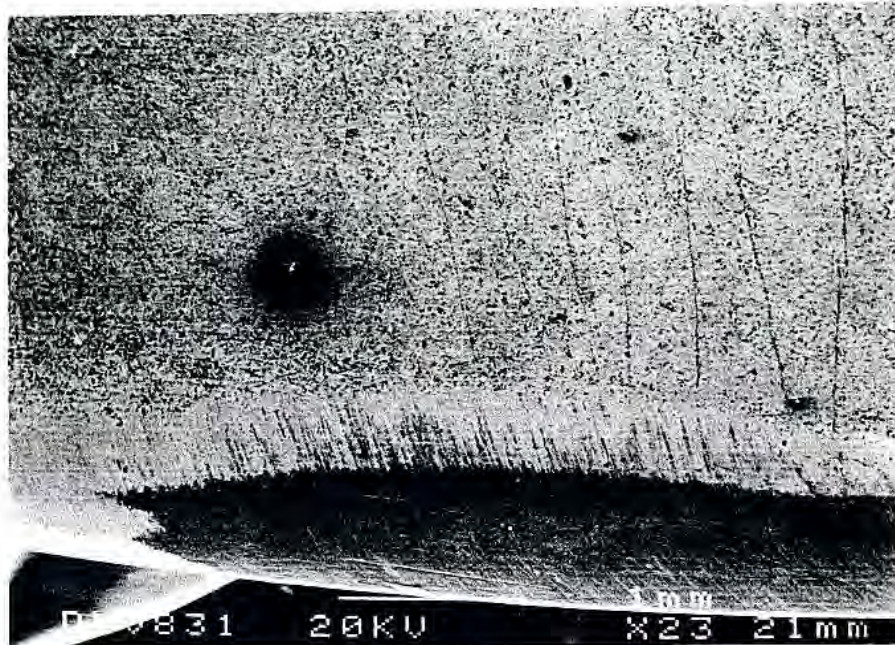

SEM-view of the R/H section of the ground front edge location "A" seen in Fig. 1. Some axially directed microcracks are indicated in the surface of the hard-metal coating.
 Magnification X 23.

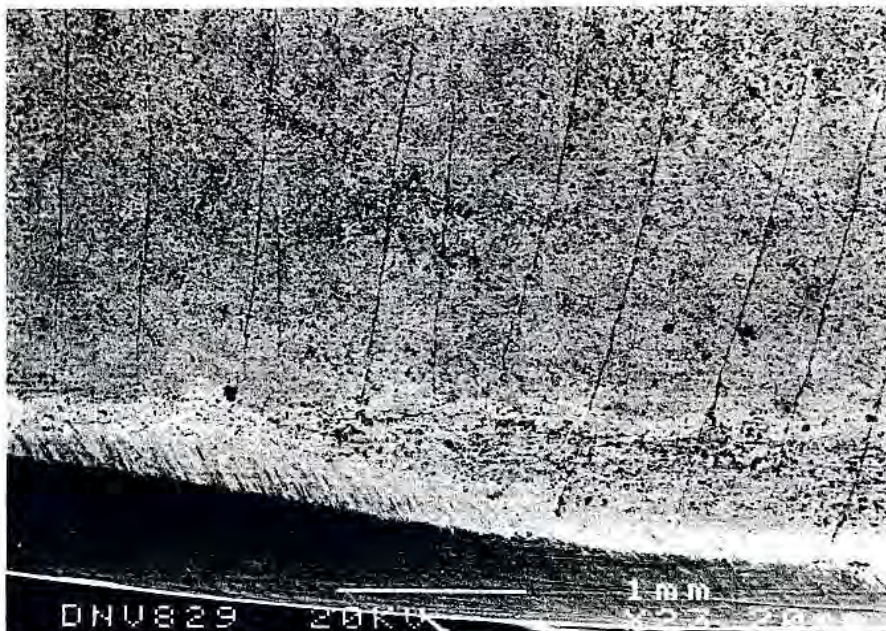

SEM-view of the middle section of the ground front edge location "A" in Fig. 1. Numerous axially directed microcracks are indicated in the surface of the hardmetal coating.
 Magnification X 23.

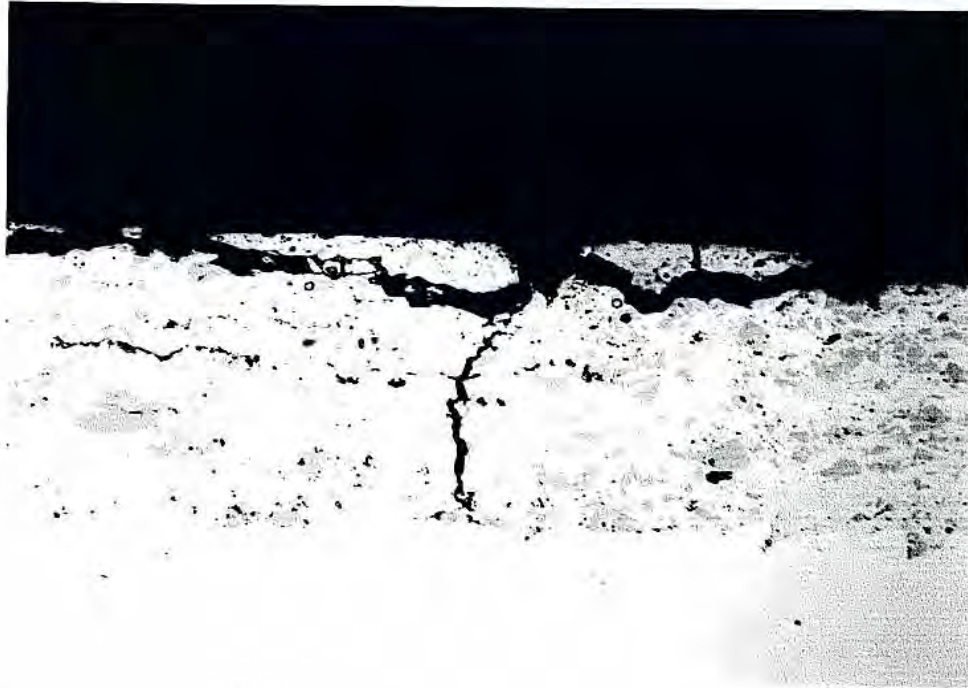

A transverse, metallographic section through a crack location where transverse cracking and also some lamination of the surface coating is observed. Magnification X 500.



Detail from the location of the crack toe. Magnification ~X 1900.

An indication of the crack front slightly penetrating the steel surface is arrowed on the photo.



Fig. 6 Close-up view of the other surface damage on the splined sleeve
marked 332 A 32-2288-22 09 CY8 33 $\frac{ML}{3}$. The surface damage in question
is designated "F".

**MEASUREMENT SKETCH
PRINCIPLE**

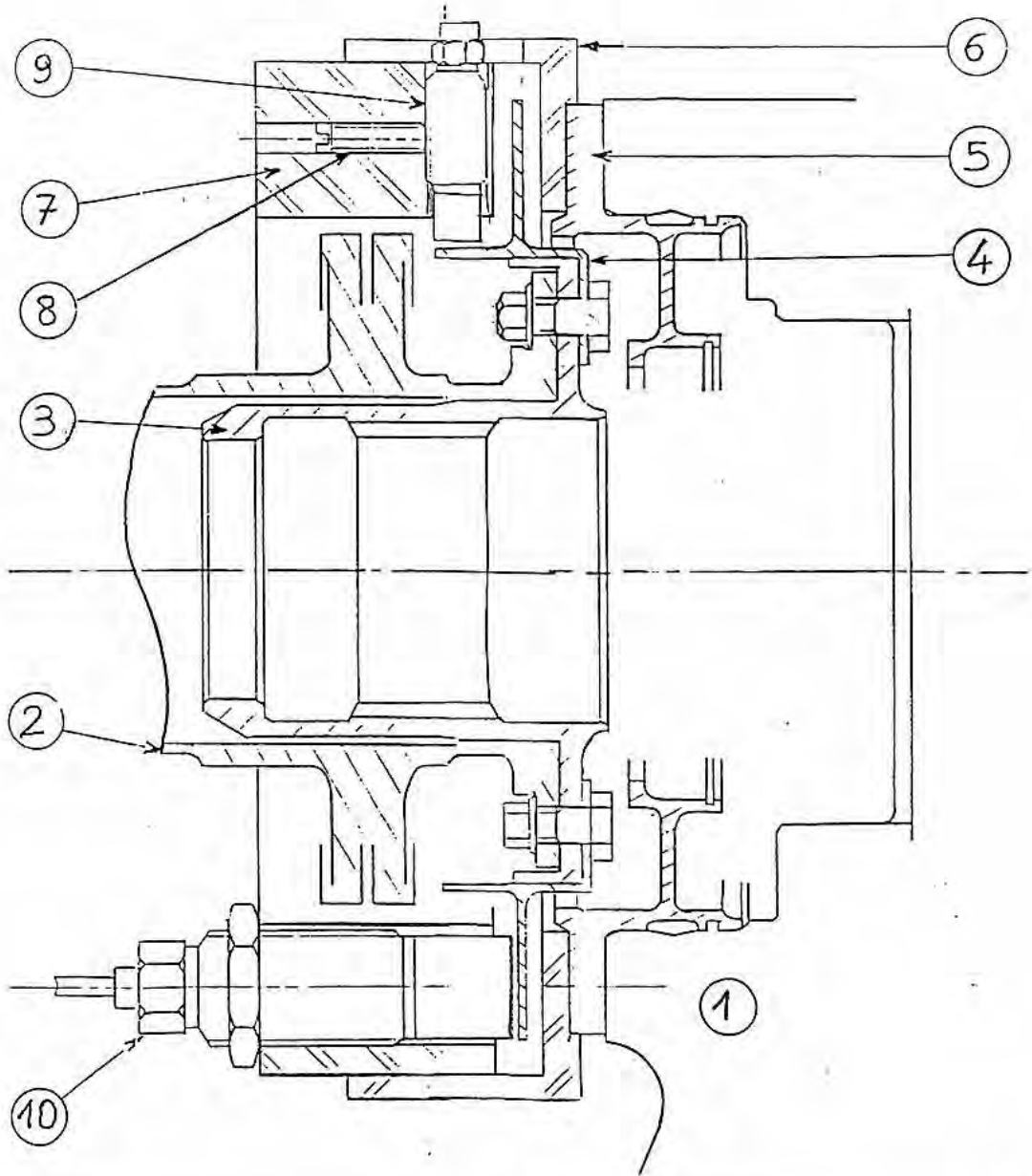

1	INPUT HOUSING (M.G.B)	6	SUPPORT SENSORS ASSEMBLY
2	"BENDIX" SHAFT	7	SEAL SUPPORT
3	"BENDIX" FLANGE	8	SET SCREW
4	ROTATING MARKING DISK	9	RADIAL PROXIMITY SENSOR
5	SEAL SUPPORT	10	AXIAL PROXIMITY SENSOR

ERREUR DE PAS DE LA ROUE 8000 tr/mn M 541 DE L'ACCIDENT NHS

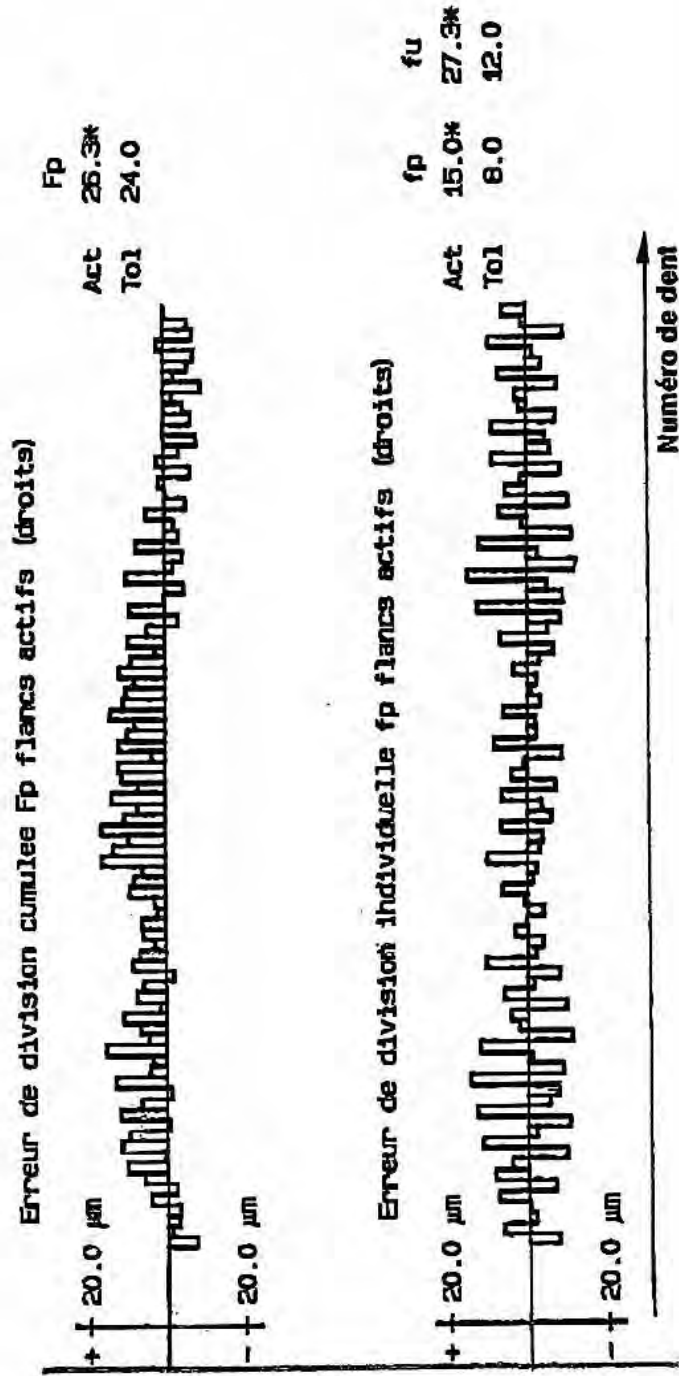
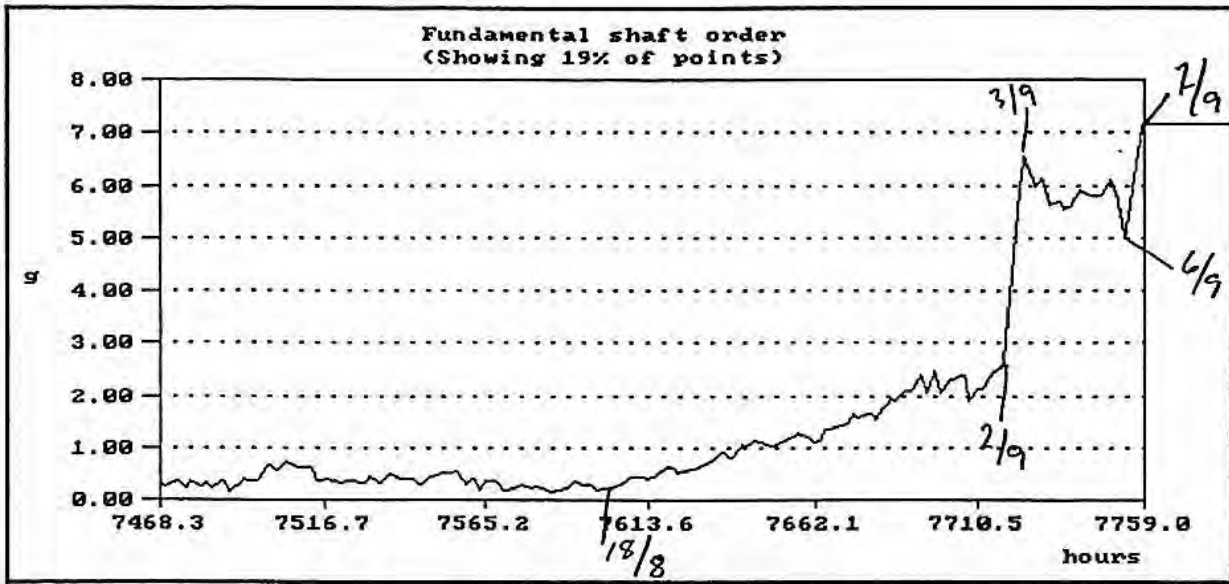
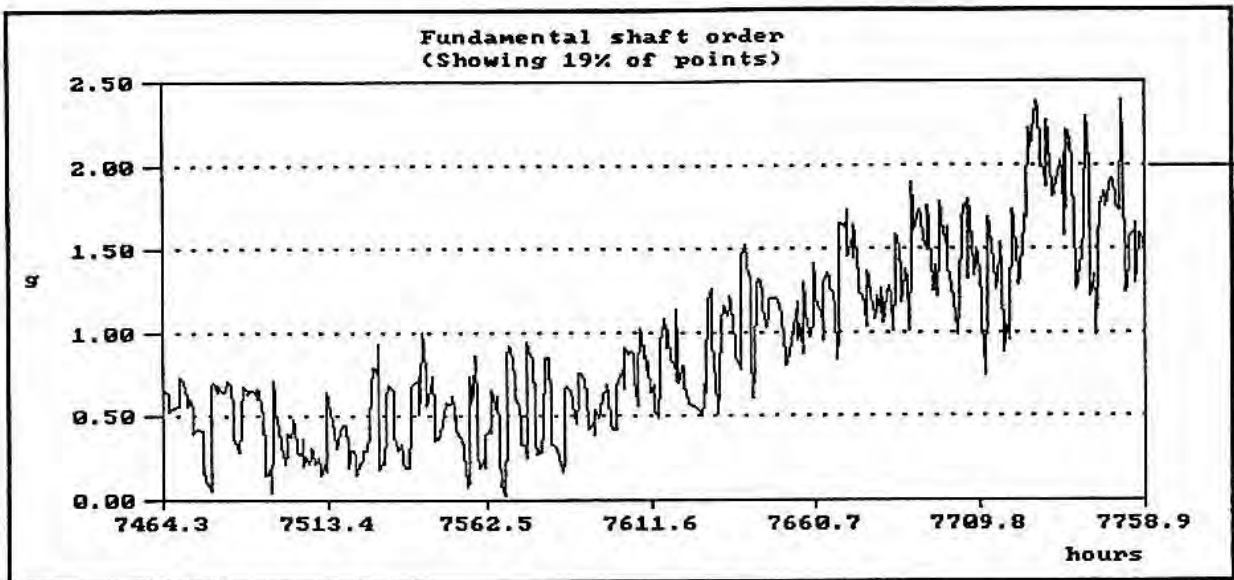

Fig. 60



Transmission/Engine Parameter Browse
Aircraft: LN-OPG Type: 332 Mod: 444(CC)
Acq Type: Engine Shafts Automatic Acquire
Channel: Engine 2 Driveshaft



Transmission/Engine Parameter Browse
Aircraft: LN-OPG Type: 332 Mod: 444(CC)
Acq Type: GB Shafts/Gears Automatic Acquire
Channel: LH High Speed Input Shaft

AS 332 L1 ACCIDENT LN-OPG INVESTIGATION RESULTS - ECF 3/2/99



LN - OPG N2 SENSORS R/H ENGINE

ENGINE
SIDE

MGB
SIDE

ENGINE
SIDE

MGB
SIDE

Control sensors

N° 2036

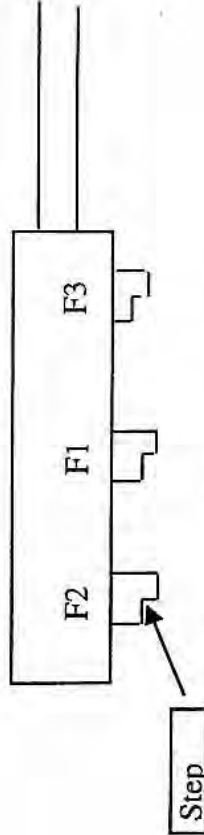

OK OK OK

Wear compared to nominal 17,25 mm	-0,11 mm	-0,22 mm	-0,4 mm
Step	-0,14 mm	-0,23 mm	-0,5 mm

Indication and overspeed sensors

N° 2018

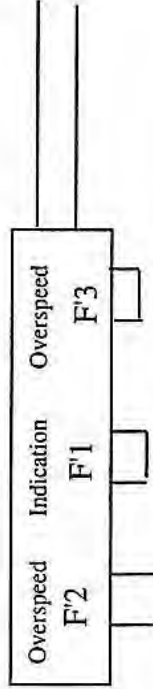

H.S H.S OK

Wear compared to nominal 17,25 mm	-0,1 mm	-0,32 à -0,42 mm	-0,3 à -0,5 mm
-----------------------------------	---------	------------------	----------------

NOTA:

OK means sensor gives still a signal (voltage) above 0,2 V

HS means sensor gives no signal available to EECU.

ORGANISATION

ORGANISATION CHART

Technical Organisation

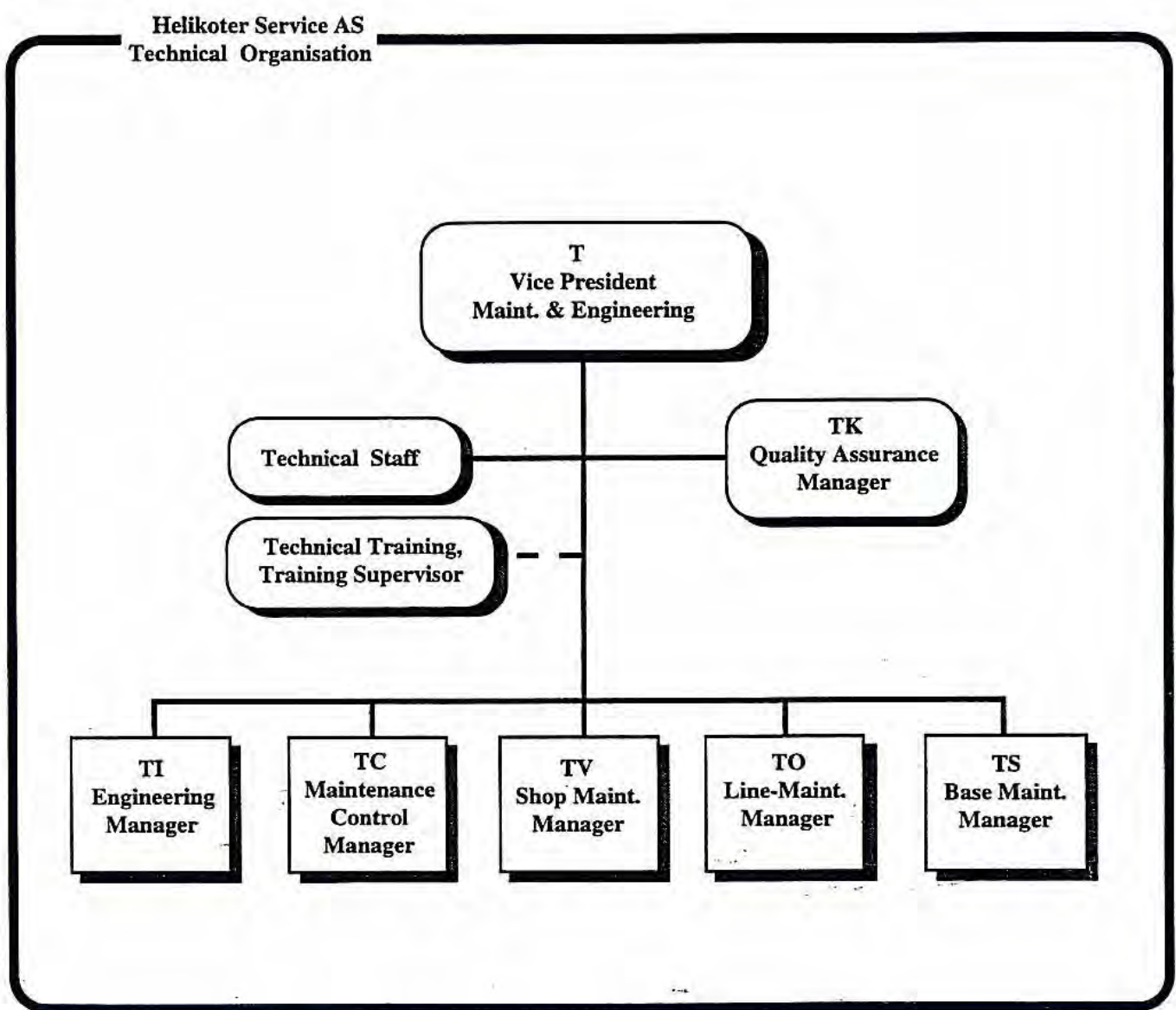

Note: Only facilities at Sola are covered by the FAA FAR 145 Repair Station Approval.

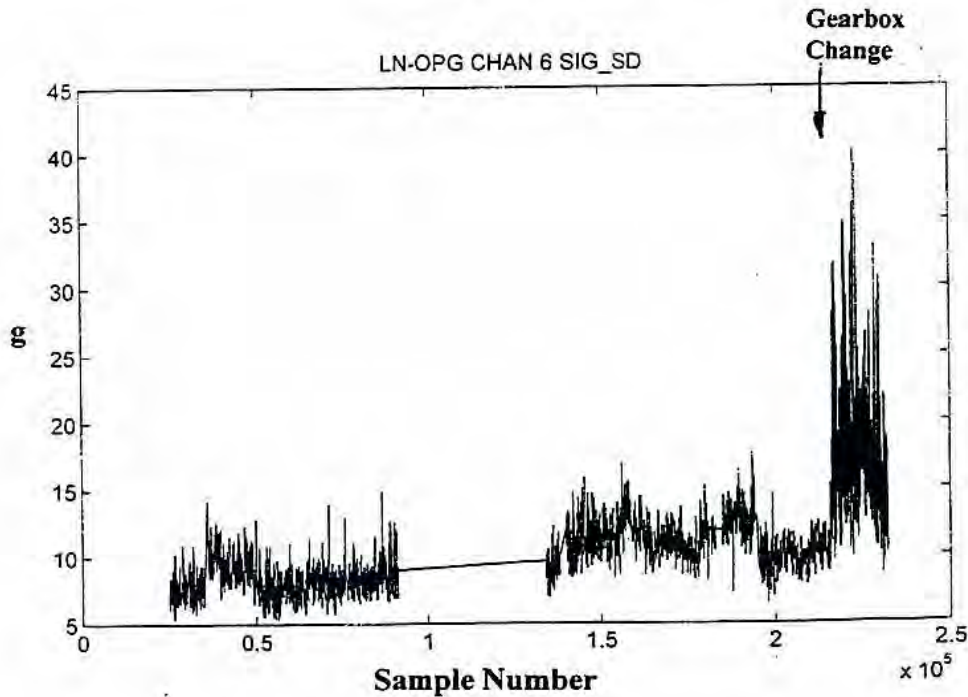
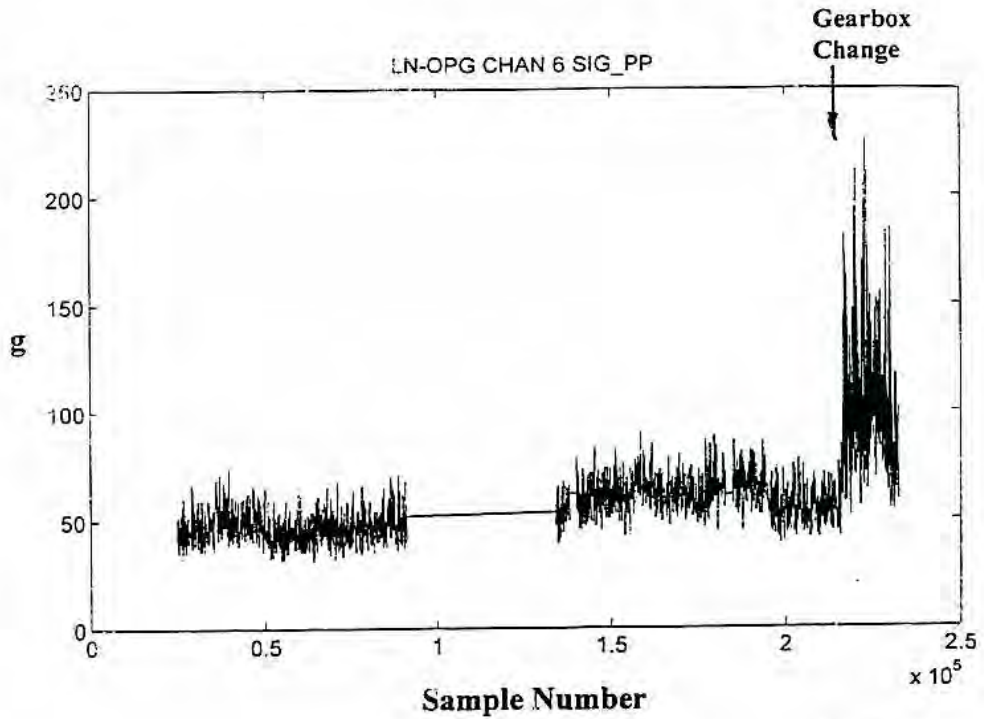

TRENDS OF PARAMETERS SIG_PP AND SIG_SD
FOR RIGHT TORQUE (FREEWHEEL) SHAFT AFT END
DAPU CHANNEL 6 (LN-OPG)



GKN Westland
Helicopters

GKN-WESTLAND HELICOPTERS LTD
PROPRIETARY INFORMATION

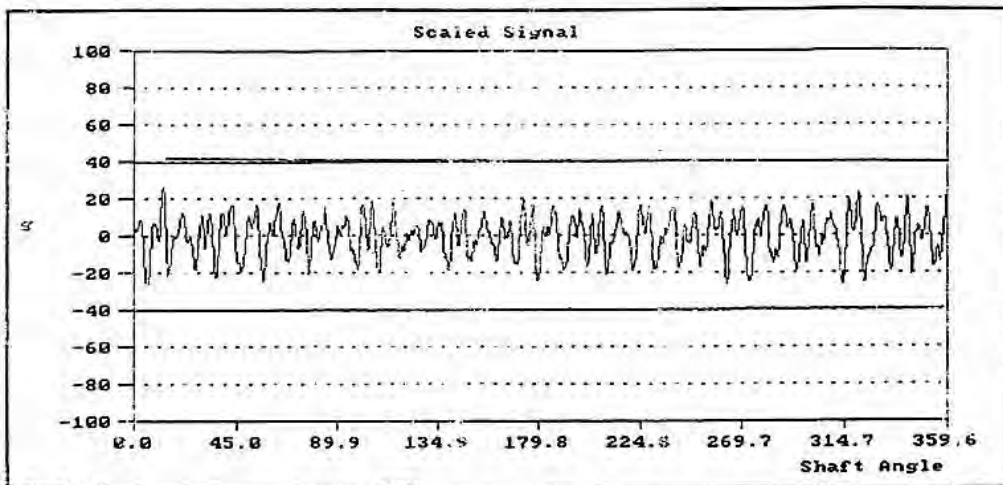

IHUMS A/F Hours
7172.08
Download 1108B Acq 000
SIG_PP 52 SIG_SD 10.6

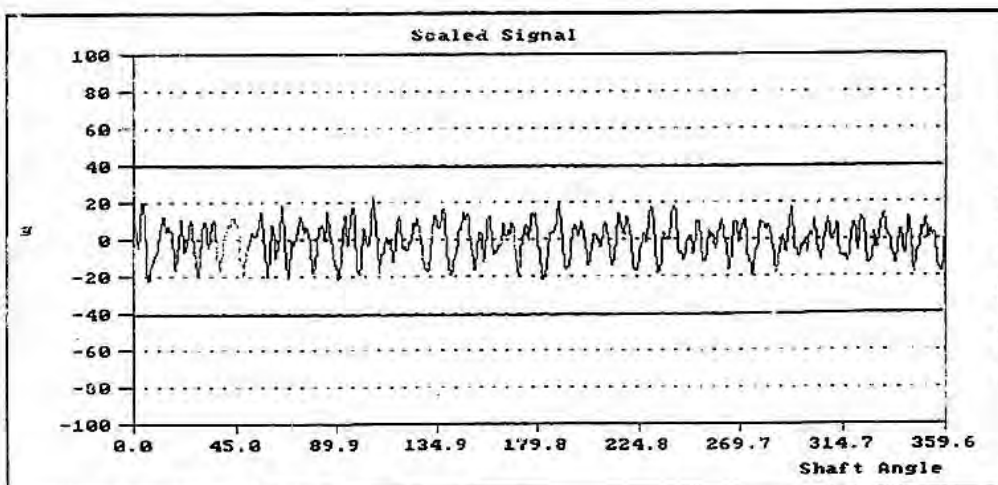

15/1 - 97

IHUMS A/F Hours
7172.82
Download 1108B Acq 001
SIG_PP 45 SIG_SD 9.3

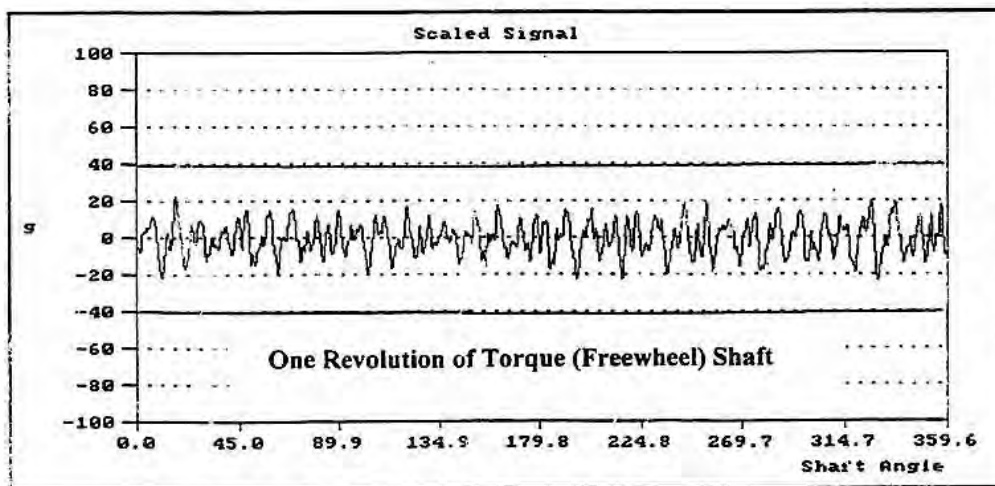

IHUMS A/F Hours
7173.77
Download 1108B Acq 002
SIG_PP 46 SIG_SD 8.9

SIGNAL AVERAGES OF RIGHT TORQUE
(FREEWHEEL) SHAFT AFT VIBRATION - DAPU CHANNEL 6
LN-OPG DOWNLOAD 1108B



GKN Westland
Helicopters

GKN-WESTLAND HELICOPTERS LTD
PROPRIETARY INFORMATION

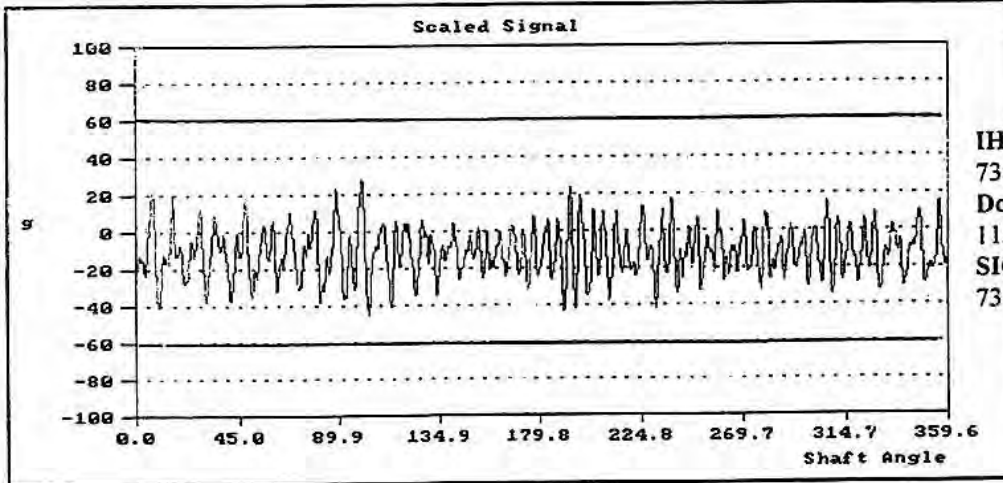
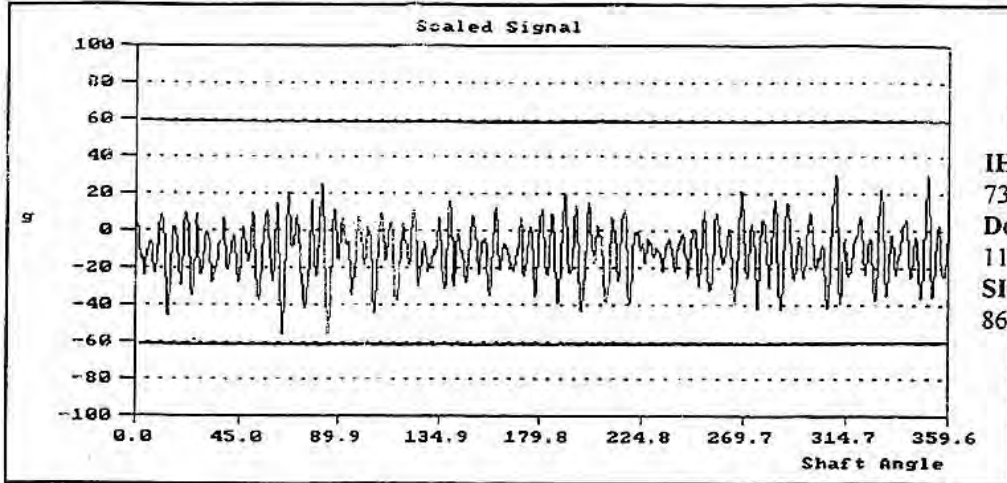

4/7-97

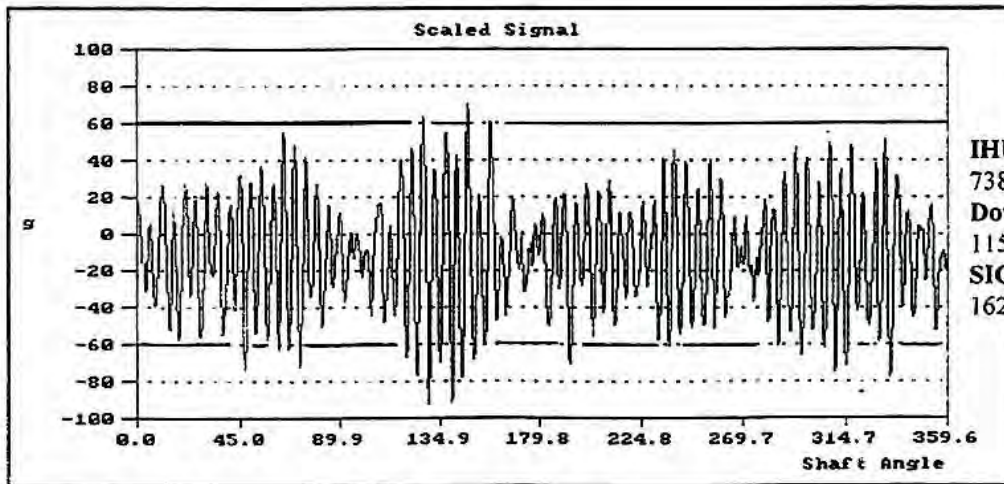

SIGNAL AVERAGES OF RIGHT TORQUE
(FREEWHEEL) SHAFT AFT VIBRATION - DAPU CHANNEL. 6
LN-OPG DOWNLOAD 1151A



GKN-WESTLAND HELICOPTERS LTD
PROPRIETARY INFORMATION

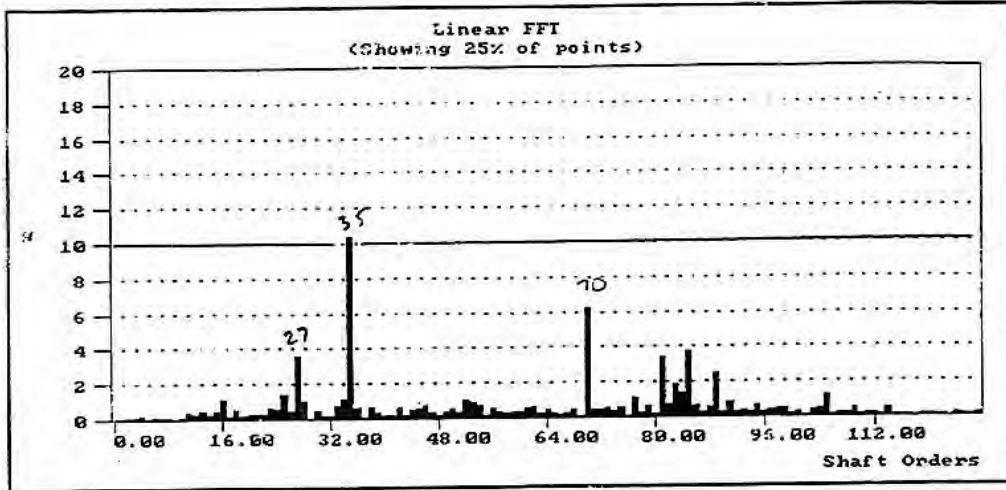

IHUMS A/F Hours
7172.08
Download 1108B Acq 000

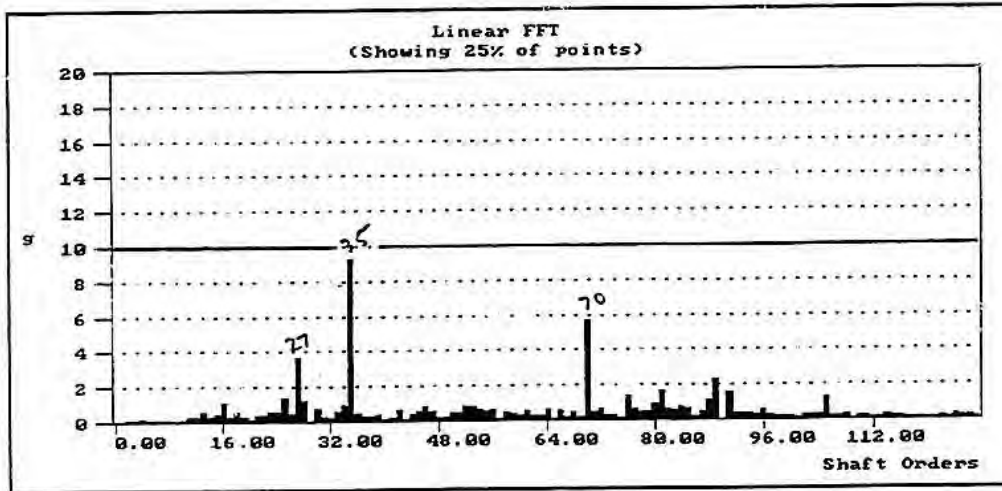

15/1-97

IHUMS A/F Hours
7172.82
Download 1108B Acq 001

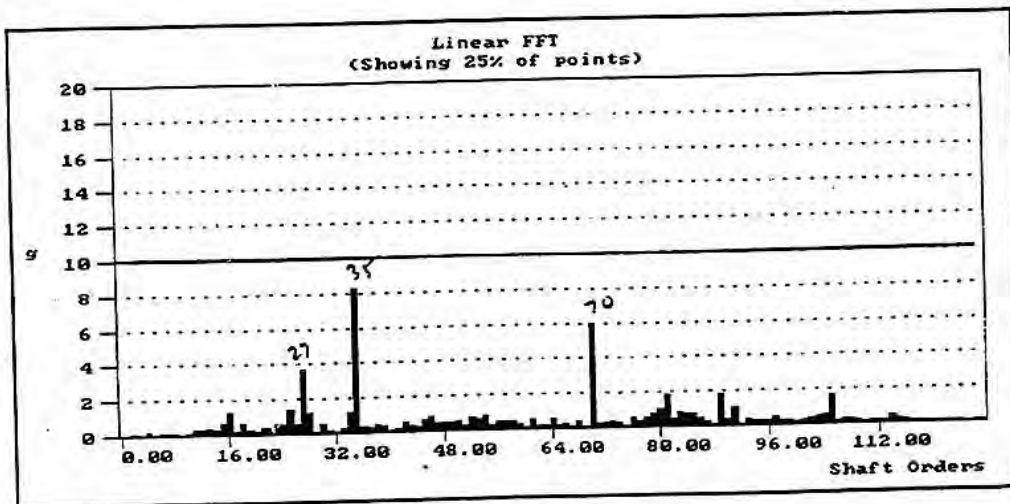

IHUMS A/F Hours
7173.77
Download 1108B Acq 002

FREQUENCY SPECTRA OF SIGNAL AVERAGES OF RIGHT TORQUE
(FREEWHEEL) SHAFT AFT VIBRATION - DAPU CHANNEL 6
LN-OPG DOWNLOAD 1108B



GKN Westland
Helicopters

GKN-WESTLAND HELICOPTERS LTD
PROPRIETARY INFORMATION

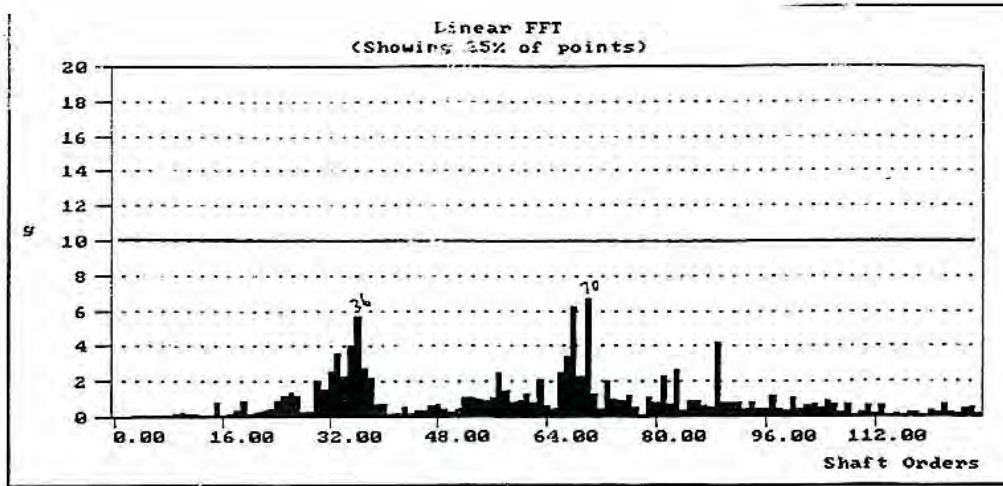

IHUMS A/F Hours
7475.99
Download 1172A Acq 000

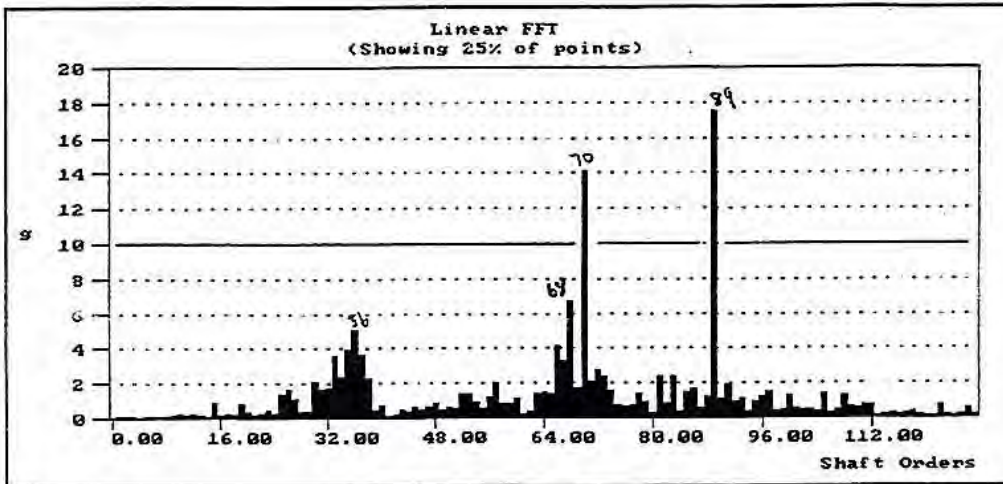

IHUMS A/F Hours
7476.93
Download 1172A Acq 001

1/8-97

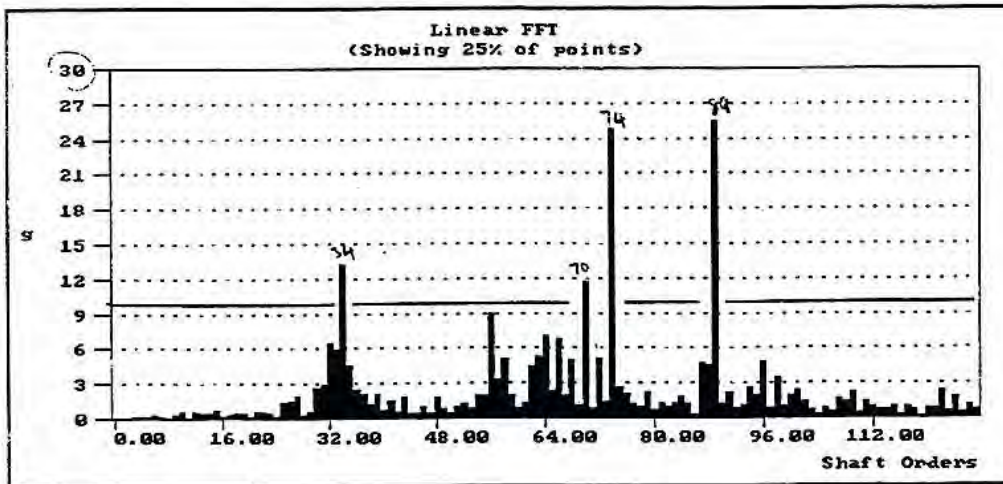

IHUMS A/F Hours
7478.45
Download 1172A Acq 002

FREQUENCY SPECTRA OF SIGNAL AVERAGES OF RIGHT TORQUE
(FREEWHEEL) SHAFT AFT VIBRATION - DAPU CHANNEL 6
LN-OPG DOWNLOAD 1172A

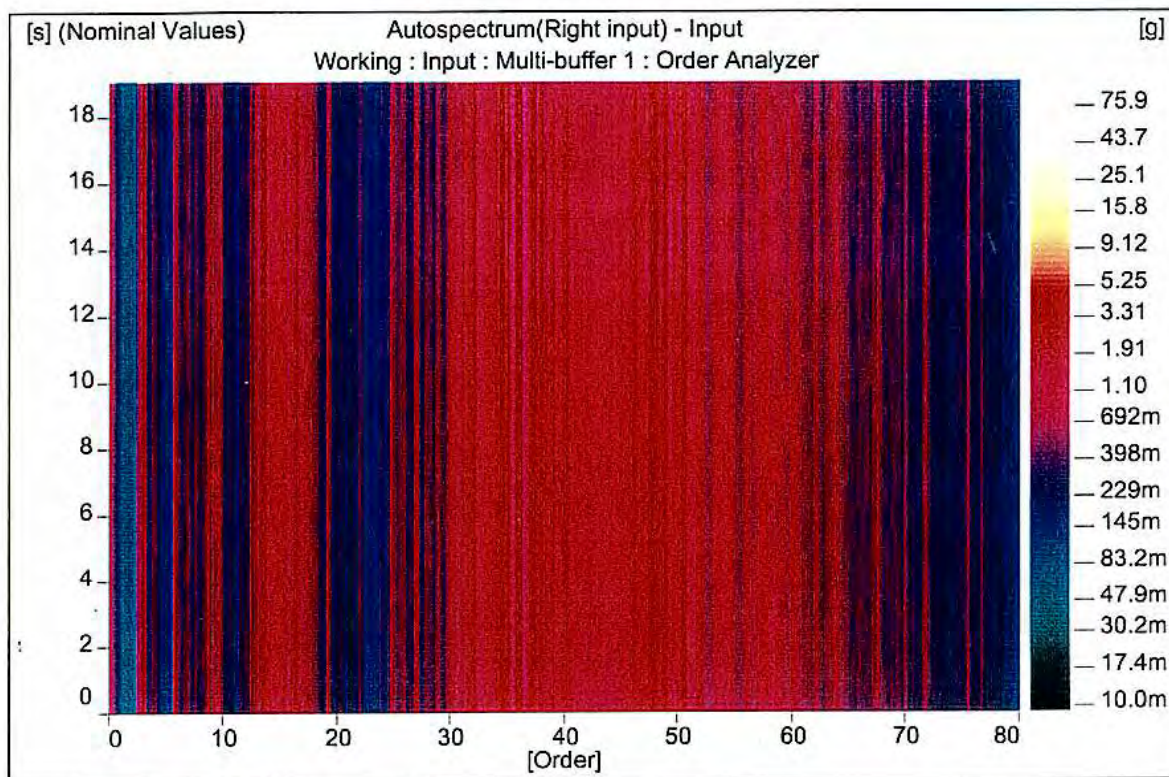

Figure 5: T1R1 /32 Avr. Right input, O-rings installed, Load 600Nm

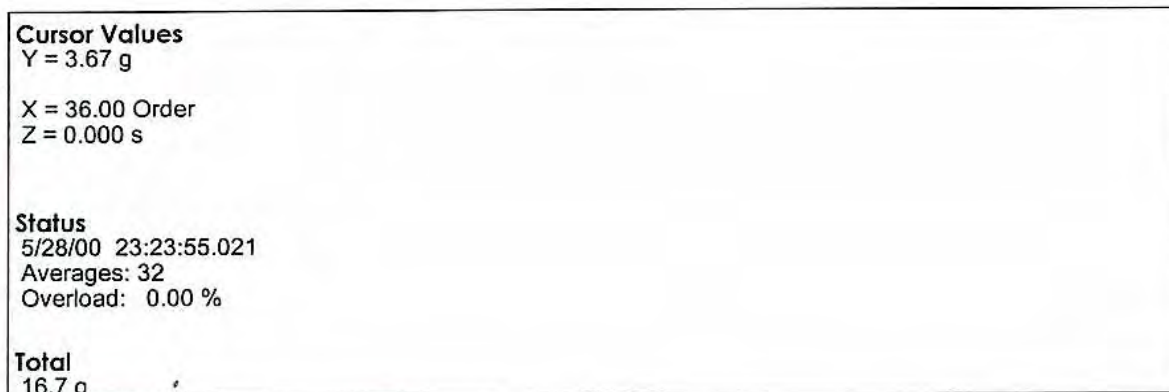

Figure 6: Cursor for Right input, O-rings installed, Load 600Nm

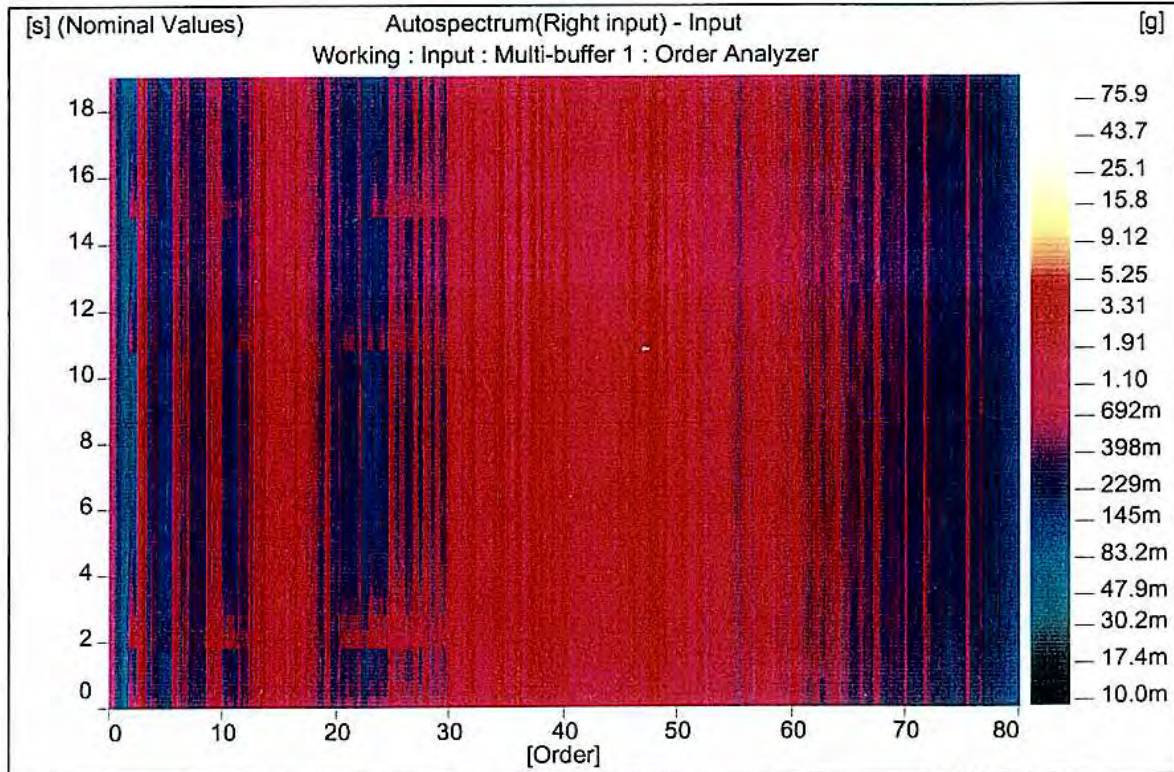

Figure 21: T2R1 /32 Avr. Right input, O-rings removed, Load 600Nm

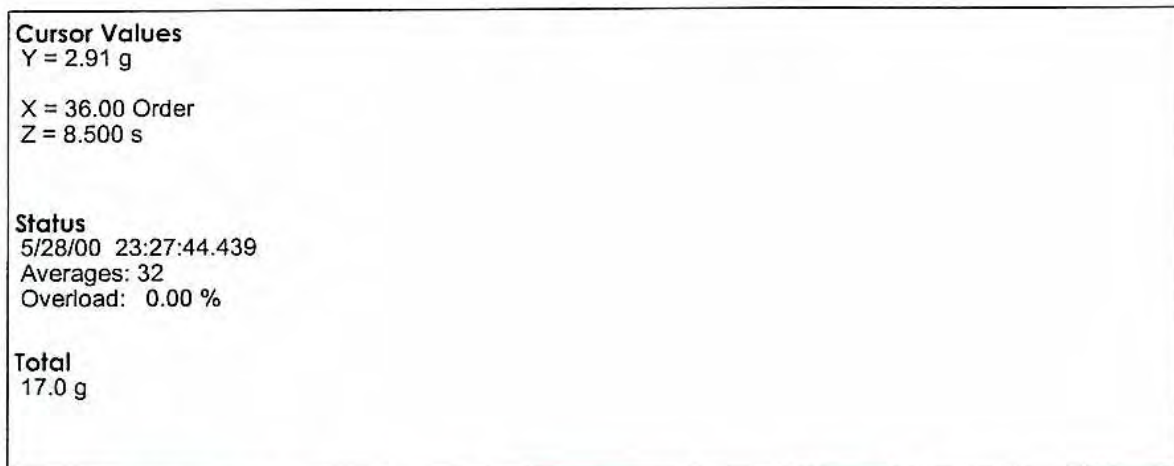

Figure 22: T2R1 /32 Avr. Cursor for Right input, O-rings removed, Load 600Nm

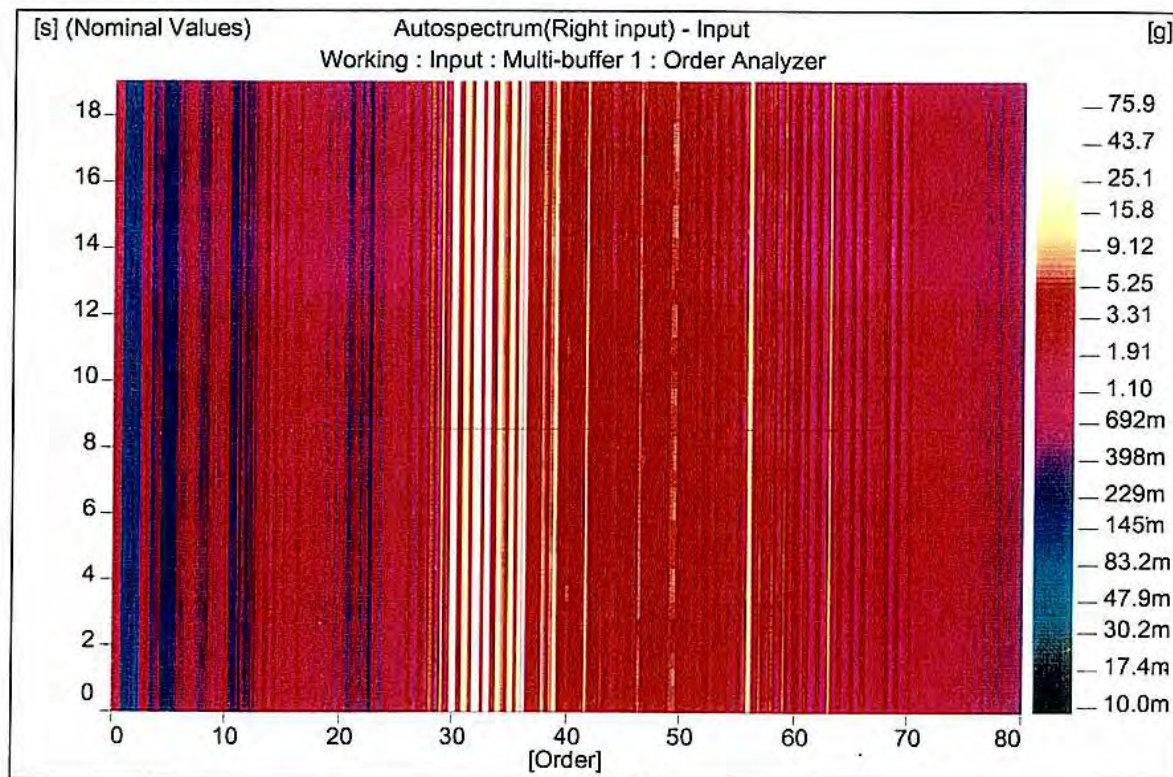

Figure 37: T3R1 /32 Avr. Right input, O-rings installed, Load 600Nm, 8000 gear S/N M541 on RH side1

Cursor Values	
Y =	37.0 g
X =	36.00 Order
Z =	8.500 s
Status	
5/28/00	23:06:47.031
Averages:	32
Overload:	0.00 %
Total	
	156 g

Figure 38: T3R1 /32 Avr. Cursor for Right input, O-rings installed, Load 600Nm, 8000 gear S/N M541 on RH side1

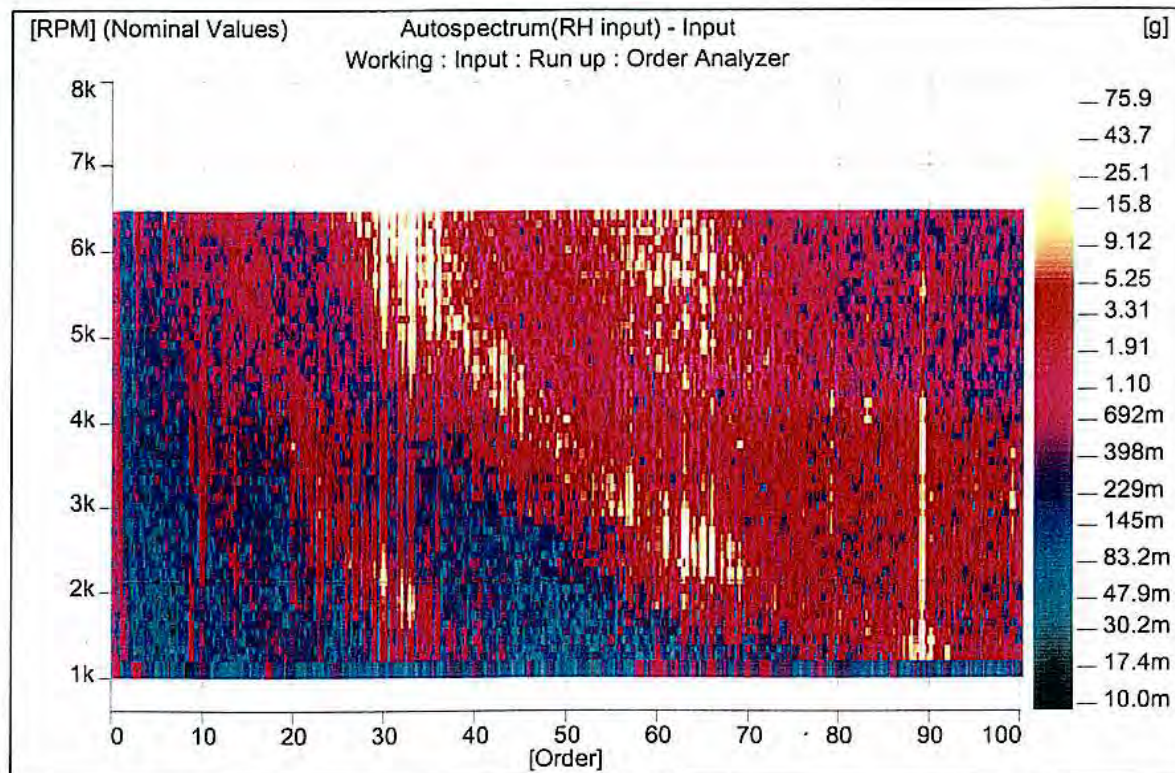

Figure 43: T3R2, Right input, O-rings installed, Run up 600 - 8000 RPM, 8000 gear S/N M541 on RH side

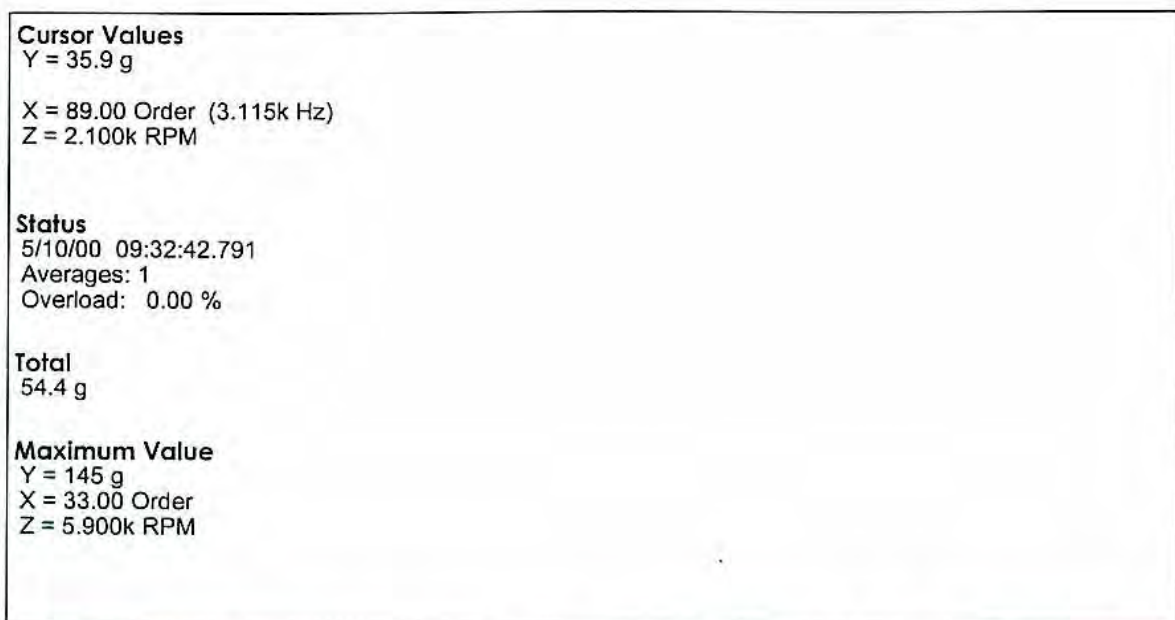

Figure 44: T3R2, Cursor for Right input, O-rings installed, Run up 600 - 8000 RPM, 8000 gear S/N M541 on RH side

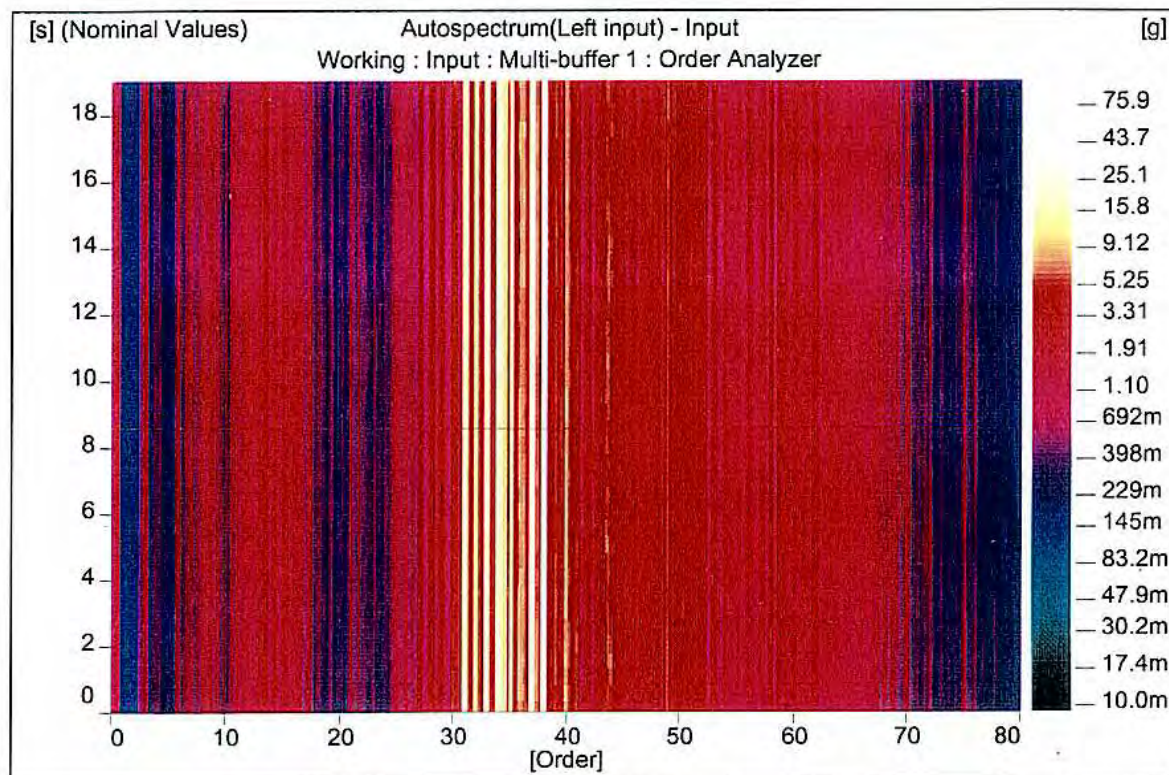

Figure 97: T8R1 /32 Avr. Left input, O-rings installed, Load 600Nm, MGB S/N M136 on LH side

Cursor Values
 Y = 8.00 g
 X = 36.00 Order
 Z = 8.500 s

Status
 5/29/00 02:17:05.287
 Averages: 32
 Overload: 0.00 %

Total
 78.4 g

Figure 98: T8R1 /32 Avr. Cursor for Left input, O-rings installed, Load 600Nm, MGB S/N M136 on LH side

Fig. 73

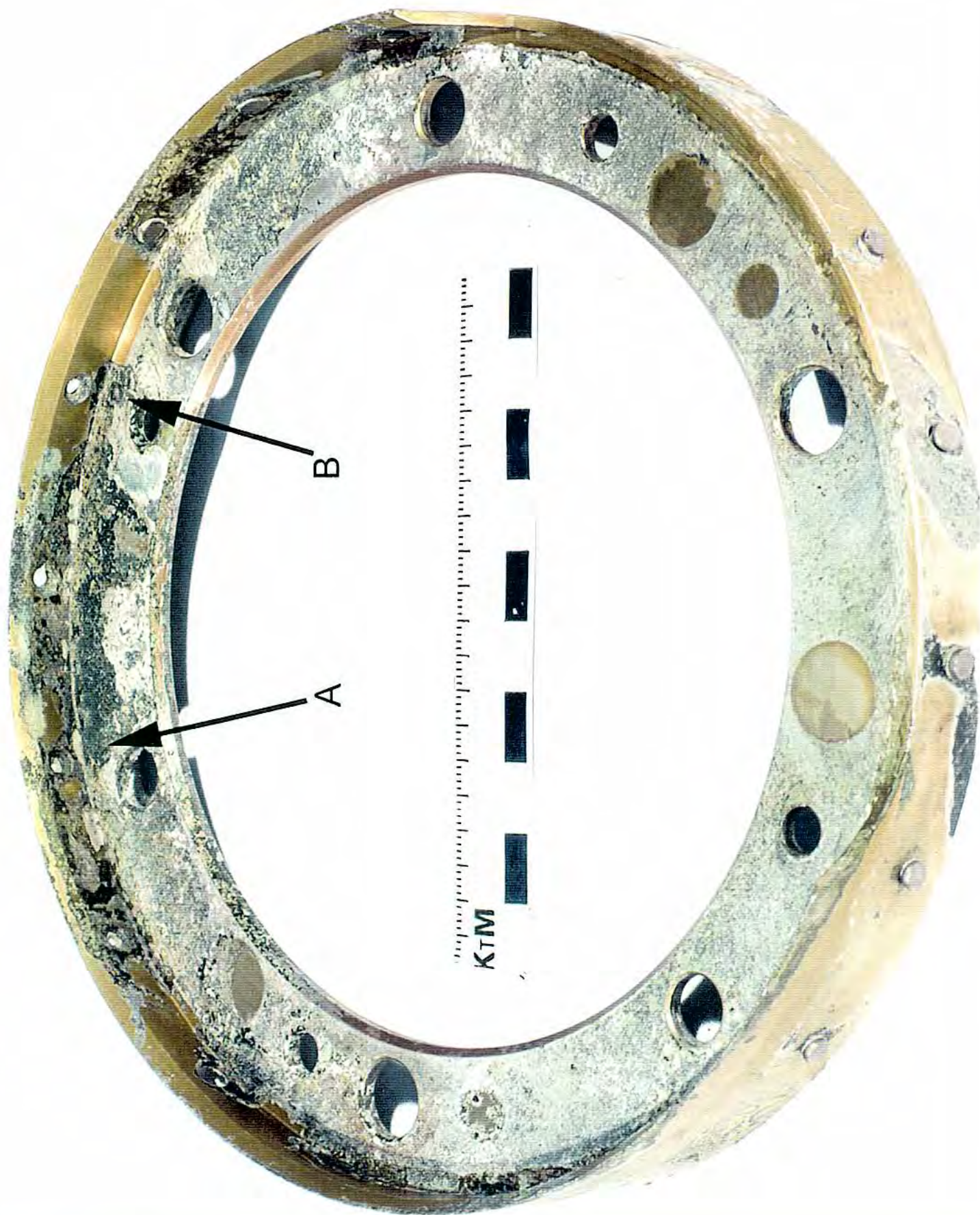

Fig. 74



Fig. 75



MAINTENANCE

ENGINE - MGB COUPLING : 23000 rpm INPUT	332	63.10.00.602
Verification		95-12 Page 1

1 EQUIPMENT REQUIRED

Also refer to "EQUIPMENT REQUIRED" section of documents referenced in 1.4.

1.1 Special Tools

None

R

1.2 Materials

- Molykote "G.Rapid plus" (molybdenum disulfide anti-seizing compound)
- Emery cloth, 400 grit
- Dykem DX296 or Steel Blue (marking)
- Oil 0.156

R

1.3 Routine Replacement Parts

- (6) seal IPC 63.28.10

R

1.4 Applicable Documents

- Maintenance Manual (MET) :
WC 63.10.00.401 - 63.20.00.501 - 71.00.00.401
- Repair Manual (MRR) :
WC 63.10.00.701 - 63.28.00.702
- Standard Practices Manual (MTC) :
WC 20.01.01.312 - Products for dry lubricating film
- 20.02.05.404 - Assembling by bolts and nuts
- 20.02.09.101 - General principles for performing dye penetrant inspection
- 20.07.03.401 - Instructions for performing maintenance operations on mechanical assemblies

R

R

2 PRELIMINARY STEPS2.1 Tie-rod torque loading (PRE MOD. 07.52316 and 07.52317)

R

- Check the torque loading of the tie-rods (Figure 1, item 7) as per MTC :
 - . If OK, resume flights.
 - . If torque loading is below minimum acceptable value or if tie-rod is broken, proceed as per paragraphs 2 to 4.

2.2 Engine

- Disconnect the engine, remove it if necessary (Work card 71.00.00.401) marking the position of the flange with respect to the sleeve.

MAINTENANCE

332

63.10.00.602

96-04

Page 2

3 VERIFICATION PROCEDURE (Fig. 1)3.1 Tie-Rods

3.1.1 Tie-Rods (7) (PRE MOD. 07.52316)

- Check for fretting corrosion on the plain portion of tie-rods (7). Slight fretting is acceptable if it can be sanded off with abrasive cloth. If excessive wear is noted, replace the tie-rods within the next 50 operating hours.

3.1.2 Tie-Rods (11) (POST MOD. 07.52316)

- Scrap tie-rods (9) if :
 - . they can be unscrewed by hand or they have failed, R
 - . cracks, fretting or stripped threads are found,
 - . fretting is found on washer (10) which is detached from tie-rod. R

3.2 Corrosion

- Visually check for fretting corrosion on diameter "B" of sleeve (4). Slight black or rust-colored fretting is acceptable on the plain portion of diameter "B" if it can be sanded off with abrasive cloth.

3.3 Fretting Corrosion with Scratches or Wear Remaining After Sanding

- Replace sleeve (4) (Work Card 63.28.00.702) ; seal (6), nut (5) and lockwasher (3).
- If installing an overhauled sleeve, carry out dye-penetrant examination (Work Card 20.02.09.101) on surface shown thus : ++++. R

3.4 No Fretting Corrosion, or Fretting Corrosion Eliminated by Sanding

- Remove seal (6).
- Carry out dye penetrant examination (Work card 20.02.09.101) on surface shown thus : ++++.

3.4.1 Cracks Revealed by Examination

- Remove and replace splined sleeve : check for cracks if sleeve is not new.

3.4.2 No Cracks

- Measure clearance between flange (2) diameter "A" and sleeve (4) diameter "B" : this clearance should be greater than 0.05 mm.

3.4.2.1 Clearance Incorrect

- Replace splined flange (2) (Work card 63.10.00.701).

3.4.2.2 Clearance Acceptable

- Fit seal (6).

4 INSTALLATION4.1 Shaft and Flange Reinstalled Without Replacement

- Inspect splined flange (2) without removing it from shaft (1).
- Check that no wear is visible on bore "C" diameter ; if wear is found, measure the depth :
 - . if wear depth does not exceed 0.03 mm, reinstall the assembly.
 - . if wear depth exceeds 0.03 mm, replace flange (2) (Work Card 63.10.00.701).
- Check concentricity error of sleeve (4) as per § 5.

4.2 Shaft and/or Flange Replaced

- Measure clearance between "A" diameter of flange (2) and "B" diameter of sleeve (4) : this clearance must be greater than 0.05 mm.
- If clearance is outside tolerance limits, remove and replace sleeve (4) (Work Card 63.28.00.702) so as to obtain correct clearance between diameters A and B.

NOTE 1 : - Measure diameter "B" on sleeve (4) with nut (5) and lockwasher (3) installed.

NOTE 2 : - Proceed as per Work Card 63.10.00.701 if flange (2) and shaft (1) are disconnected.

- Remove grease from sleeve (4) and flange (2) from the outside to prevent buildup inside the shaft.
- Check concentricity error of sleeve (4) as per paragraph 5.
- Apply a film of Molykote G RAPID PLUS on internal splines of flange (2) and external splines of sleeve (4).

NOTE : Before installing the engine if room temperature is below +30°C, heat flange (2) bore diameter "C" and seal (6) to about 30°C using a hot air generator.

5 SLEEVE CONCENTRICITY CHECK

- Install a dial indicator on the MGB casing as shown in Figure 2 : set dial indicator tip on the middle of the sleeve (4) diameter.
- Manually turn the MGB tail rotor output shaft and note the concentricity error on the dial indicator as sleeve (4) rotates.
- Mark the maximum error position on the seal retaining ring (8) and on the sleeve.
- If the concentricity error does not exceed 0.12 mm, no work is necessary and the module may be restored to service.
- If the concentricity error exceeds 0.12 mm, remove the MGB (Work card 63.20.00.401) for examination of the 23000 rpm input module and contact the Aerospatiale Technical Support Department (H/CS.ST).

6 FINAL STEPS

NOTE : Any shaft or flange removed because it is outside tolerance limits must be returned to EUROCOPTER with the reason for removal indicated on the equipment log card.

- Install engine (Work card 71.00.00.401) : line up marks made before removal, and replace G.720 grease with Molykote G RAPID PLUS. R
- Check vibration level (Work Card 63.20.00.501). R

NOTE : Check torque loading of tie-rods (7) as per parag. 2.1 after 3 to 10 hours of operation. R

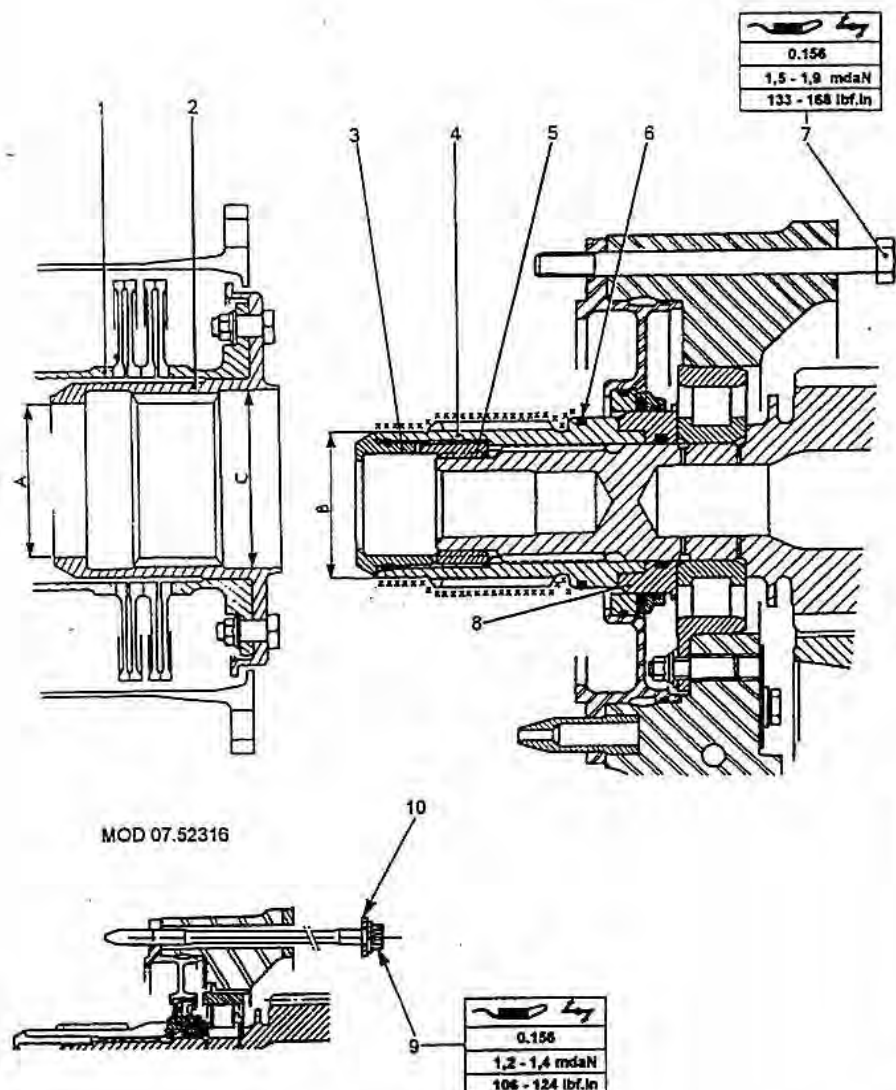

MAINTENANCE

<u>POWER PLANT</u>	332	71.00.00.401
Engine - Disengagement Removal-Installation		95-12 Page 1

1 EQUIPMENT REQUIRED

Also refer to the "Equipment Required" in the publication mentioned in 1.4.

1.1 Special tools

Portable crane	332A91-3000-02/03	
"MAKILA" engine hoisting sling	332A91-5400-00	
Blanking MGB	332A96-3204-00 (332A96-3200-00/01)	
Mooring rope	703A92-0020-00	
Support mount, "MAKILA" engine	8814083000	
Walkway assembly, engine cowling	(Aircraft tool kit complement)	
Blank, engine air intake	332A96-5400-00	

1.2 Materials

White spirit		
Grease	G.355	
Molykote	M.77	
Molykote	G rapide +	
Oil	0.156	R
0.8 mm dia. lockwire	Z3CN18	

1.3 Routine replacement parts

None

1.4 Applicable documents

- Maintenance Manual (MET) :
 - WC 07.30.00.201 - 53.50.00.501 - 63.10.00.602 - 63.20.00.501 - 71.00.00.301 - 76.10.00.501
- Standard Practices Manual (MTC) :
 - WC 20.01.01.312 - Products for dry lubricant film :
 - Molykote G-M-77-Z and spray 321 R
 - 20.02.05.404 - Assembling by bolts and nuts R
 - 20.02.06.402 - Safelying with lockwire
 - 20.04.01.401 - Cleaning mechanical parts
- Flight Manual (PMV) : R
 - Chapter 8.3 R

2 FOREWORD

According to the operations to be performed, apply the power plant general instructions as per Work Card 71.00.00.301.

CAUTION : DO NOT ROTATE THE REMOVED ENGINE BY HAND - THE BENDIX COUPLING SHAFTS COULD BE DAMAGED. SUPPORT THE COUPLING SHAFT, REMOVE IT IF NECESSARY.



HS REVISION

HELIKOPTER SERVICE

Manual affected:		No: HS - 024E
AS 332L / L1, MET		Date: 09.12.96
Prepared by: <i>N.N.</i>	Approved by: <i>M.N.</i>	Page: 1 of 1

Insert this page facing: Chapter 71.00.00.401, page 1.

SUBJECT: INSTALLATION OF ENGINE

REASON: Missing information for test flight requirements, adjustment test after installation and alternate grease type.
Revision E: reference to removal - installation procedure added.

EFFECTIVITY: AS 332L, S/N; all.
AS 332L1, S/N; all.

REFERENCE: Flight Manual chapter 8.3.

DESCRIPTION:

1. Engine removal - installation procedure.
 - A. Main Task 72, Engine removal - installation is located in MRM chapter 2, ATA 71.
2. Para. 1.2, Materials, alternate Grease type.
 - A. Molycote Un Grease may be used as an alternative for Molycote M.77.
3. Para. 6, Final Steps, additional steps for installing a new, overhauled, repaired or different Engine.
 - A. Perform general check of Engine law MEM 71.00.03.
 - B. Perform Bleed Valve Threshold check law MEM 75.30.701.
 - C. Perform SOAP.
 - D. Check MET 05.21.00.201, HS revision 340 for Flight Test Requirements and HS revision 311 for Maintenance Requirements after installation of Engine.

3 PRELIMINARY STEPS

- Install access equipment.
- Open sliding cowling and engine cowlings.
- Install engine cowling walkway assemblies.
- Move air intake stub frame forward.

4 REMOVAL

NOTE : Before disconnecting the MGB/Engine coupling, check the tightening torque of tie bolts according to Work Card 63.10.00.602, paragraph 2.1. During this uncoupling operation, mark the respective angular positions of both the splined flange and sleeve. If corrosion is detected on the sleeve, comply with the instructions stated in Work Card 63.10.00.602, paragraph 3.

- Turn the blades in such a way as to clear the working area above the engine.
- Connect safety rod (4).
- Disconnect :
 - . fuel flow control (8),
 - . inflatable seal P2-air supply pipe (1),
 - . bonding braids (13) and (16),
 - . P2-air bleed hose (5) at the air bleed sensor,
 - . fuel feed line (7),
 - . cables (2) at starter terminals, and cleats (3),
 - . connectors (15) aft of junction box (14),
 - . engine flushing line (24) from quick-disconnect union (27).
- Remove the engine compartment upper heat shield (10).
- Remove the hardware securing the engine-MGB coupling tube :
 - . (PRE MOD. 07.52316), tie-bolts (11) and washers (12) (Figure 2) (DETAIL C),
 - . (POST MOD. 07.52316), tie-bolts (29) (Figure 2) (DETAIL C1).
- Move the engine forward until the auxiliary engine mounts (17) and (26), come into contact with plates (18) and (25).
- Disconnect mounting links (21) on engine side : safety pins (19), nuts (23), washers (22) and bolts (20).
- Install the hoisting sling on the engine and install the portable crane according to Work Card 07.30.00.301.
- Secure the mooring ropes to the engine.
- Disconnect safety rod (4) and move the engine against its forward stop on the guide plate.
- Remove the engine. In so doing, be careful not to hit the firewalls.
- Guide the engine with the help of the mooring ropes.
- Place the engine on its support mount.
- Remove the mooring ropes :
- Support the BENDIX coupling shaft.
- Install the blanks on both the engines and the aircraft.
- Clean the engine deck and engine mounts with White Spirit.

R
R
R
R

NOTE : If the engine is not to be returned to the manufacturer, remove :

- the inflatable seal flange (28),
- the bleed valve seal (6),
- the protection boot from the starter terminals.

5 INSTALLATION

CAUTION : BEFORE INSTALLATION, CHECK THAT THE BENDIX COUPLING SHAFT IS CLEAN.

NOTE : For engine replacement :

- install and adjust inflatable seal flange (28),
 - install seal (6) on the bleed valve,
 - install the protection boot on the starter terminals.
- When connecting the MGB/Engine coupling, ensure the angular positions of the splined flange and sleeve marked during removal.

- Check the cleanliness of the engine deck and the MGB input flange.
- Lubricate the threads of tie-bolts (11) or (29) with oil.
- Coat the splines of the MGB input 23,000 rpm pinion with a fine, even layer of Molykote "G rapid plus" using an aerosol.
- Install the mooring ropes.
- Attach the hoisting sling to the engine and connect it to the hook on the hoisting device.
- Remove engine and MGB blanks.
- Check that the feed through conduit is fitted on the MGB casing.
- Position the engine on the deck with auxiliary engine mounts (17) and (26) bearing on plates (18) and (25), in the engine "forward" position.
- Move the engine rearward until links (21) can be connected and install bolts (20).
- Connect safety rod (4).
- Move the engine rearward against the 23,000 rpm flange on the MGB.
- Secure the MGB/engine coupling tube (9) to the MGB casing :
 - . (PRE MOD. 07.52316) washers (12) and tie-bolts (11) (Figure 1) (DETAIL C),
 - . (POST MOD. 07.52316), tie-bolts (29) (Figure 2) (DETAIL C1).

R

R

R

R

NOTE : Washer (30) can rotate freely relative to head of tie-bolt (29).

R

- Torque and lock the tie-bolts.
- Fit washers (22) on bolts (20).
- Run nuts (23) up into contact with washers (22) :
 - . if one of the slots in the nut coincides with the hole in bolt (20) (possible to fit a cotter pin), tighten nut until the next slot coincides with the hole (1/6 turn), this ensures torque load "a",
 - . if none of the slots coincides with the hole in the bolt, tighten the nut until the next slot coincides with the hole, this ensures torque load "b".

R

R

- Install pins (19).
- Install engine compartment upper heat shield (10).
- Remove the hoisting sling and the portable crane.
- Disconnect safety rod (4).
- Check clearance between mounts and plate mating plane extension :
 - . at front, clearance J = 2.5 mm (DETAIL A),
 - . at rear, clearance J' = 1 to 2 mm (DETAIL B),
 - . adjust mounts (17) and (26) if necessary,
 - . in no circumstances should an interference exist between the mounting surface extension and the engine mount.
- Install bonding braids (13) and (16).
- Connect :
 - . connectors (15) at the rear of junction box (14),
 - . cables (2) to the starter terminals and cleats (3),
 - . P2 air supply line (1) to the inflatable seal,
 - . fuel feed line (7),
 - . fuel flow control (8),
 - . flushing line (24) on quick disconnect union (27).
- Connect P2 pressure connection (5) :
 - . check that the seal is present,
 - . check that there is no interference with the other pipes.
- Adjust the position of bleed valve seal (6) :
 - . loosen seal (6) fully,
 - . remove the engine cowling walkway assembly and close and open the engine cowling,
 - . tighten the clamp.
- Check the adjustment of the fuel flow controls as per Work Card 76.10.00.501.
- Check the concentricity of the air intakes as per Work Card 53.50.00.501, paragraph 2.3.

R

6 FINAL STEPS

- Remove hoist.
- Move air intake stub frame into position and lock.
- Remove engine servicing platform, then close :
 - . engine cowlings,
 - . sliding cowling.
- Check :
 - . carry out ground run test,
 - . vibration level check on 23,000 rpm (Work Card 63.20.00.501).
- The torque load of the engine-to-MGB attachment bolts (Work Card 63.10.00.602, para 2.1), at the intervals prescribed in the Master Servicing Recommendations (PRE).
- Perform a check flight according to Flight Manual (PMV) chapter 8.3.

R

R

332

71.00.00.401

95-12

Fig. 1

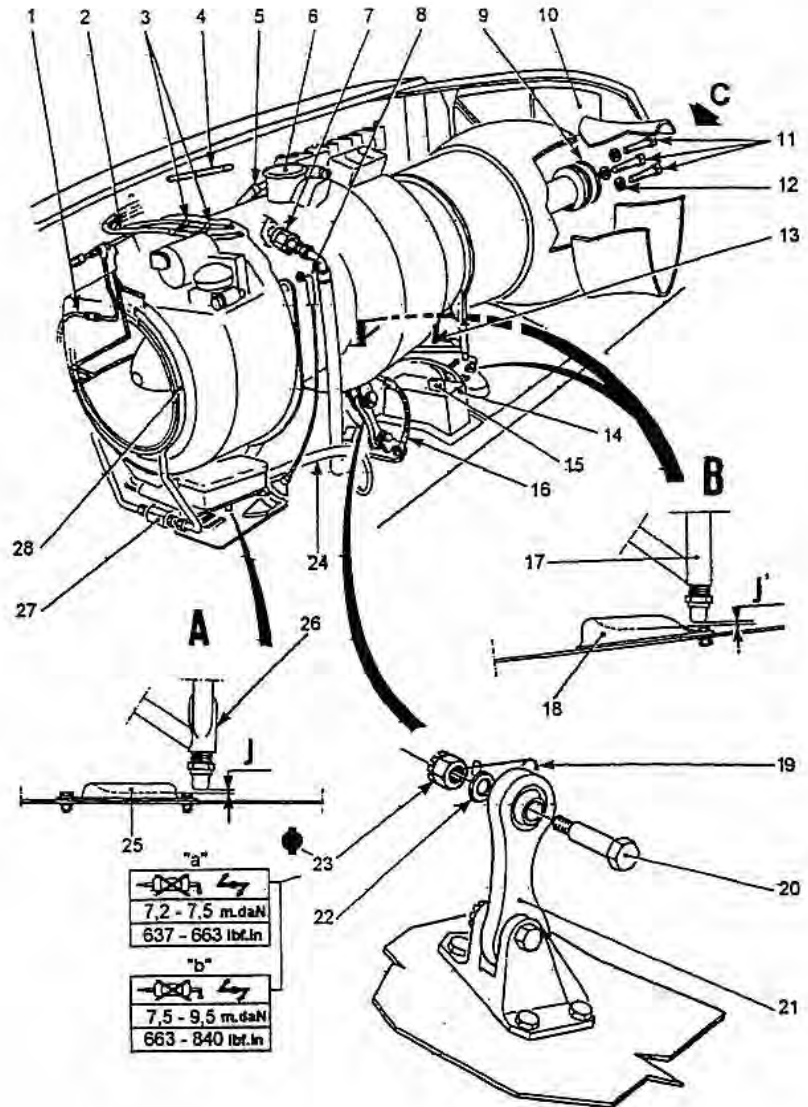

332

71.00.00.401

96-04

Fig. 2

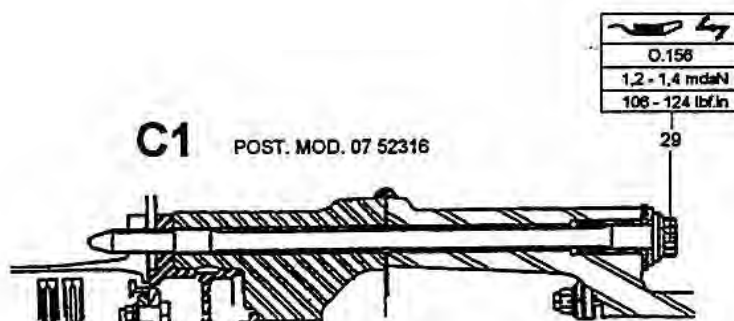
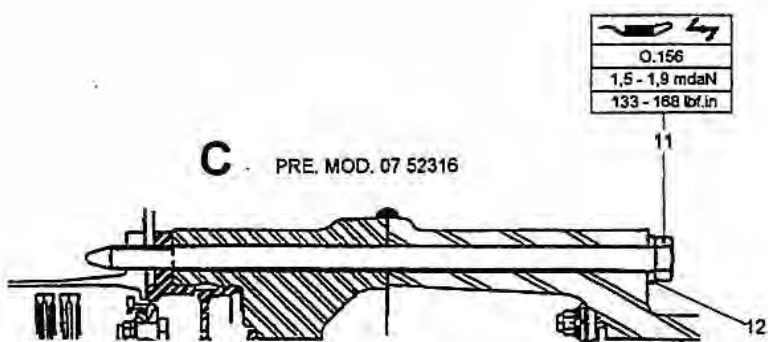

A/C Type: AS332	A/C Reg:	Interval: Dependent		HELIKOPTER SERVIC
Main Task: ENGINE REMOVAL - INSTALLATION.				Maintask number: 72
Zone: 100	Shop: 133	Mtoss: A00	ATA: 7100	Page-number: 1 of 1

	Subtask No.	Doc. ref. info.	Sign
REMOVAL OF ENGINE.	478-03	T < 70° add.	
1 Preserve Engine iaw MEM 71.00.701, page 3/9, if it is planned to be stored more than 3 days.		MEM 71.00.701 WD 48	
2 Perform check of play in Liaison Tube iaw MEM 72.51.601 and record value: 0.0 MM 0.5 mm		MEM 72.51.601	
3 Before disconnecting the MGB-Engine Coupling, check the tightening torque of Tie Rod Bolts iaw MET 63.10.00.602, para. 2.1 and record value. Left Upper: 135 Right Upper: 105 Lower: 105 During this uncoupling operation, mark the respective angular positions of Splined Flange and Sleeve.		MET 71.00.00.401 MET 63.10.00.602 MTC 20.07.03.401	
4 Unscrew Tie Rod Bolts. Push engine forward. Connect Safety Rod. Disconnect forward Mount Links from engine.		MET 71.00.00.401	
5 Disconnect the following items: Throttle Control, P2 Hose supplying Inflatable Seal, 2 ea Bonding Braids, P2 Supplying Hose from compressor (seal follow engine), Fuel Supply Hose, Cables from Starter Terminal (install bolts and spacers on engine) Connectors from Junction Box and Engine Washing Hose. Blank off "P2 supply" on Engine and in Engine Compartment.		MET 71.00.00.401	
6 Remove Engine using sling. Take care not damaging Firewall or Bendix Shaft.		MET 71.00.00.401	
7 Put Engine on a Stand. Install Blankings on engine as required.		MET 71.00.00.401	
8 Remove Inflatable Seal on Engine Inlet, if engine is not to be installed on a helicopter.		MET 71.00.00.401	
9 Remove Seal on Bleed Valve, if engine is not to be installed on a helicopter.		MET 71.00.00.401	

A/C Type: AS332	A/C Reg:	Interval: Dependent	HELIKOPTER SERVICE	
Main Task: ENGINE REMOVAL - INSTALLATION.			Maintask number: 72	
Zone: 100	Shop: 133	Mtoss: A20	ATA: 7100	Page-number: 1 of 1

	Subtask No.	Doc. ref. info.	Sign
INSPECTION BEFORE INSTALLATION.	479-03		
1 Perform visual inspection of Support Links and Bolts, upper and lower for play and condition. Clean and perform visual inspection of Engine Deck, Mating Surfaces, Attachments and Components for condition.		MET 71.00.00.401 MET 71.00.00.601	
2 Perform visual inspection of Tie Rod Bolts iaw MET 63.10.00.602, para. 3.1.		MET 71.00.00.401 MET 63.10.00.602	
3 Clean and perform visual inspection of Input Sleeves on MGB for fretting corrosion. NOTE: If new MGB, new Sleeve on MGB Input or Bendix Shaft is installed, measure diameter on Input Plain Splines, and diameter on Bendix Coupling inside Splines iaw MET 63.10.00.602.		MET 71.00.00.401 MET 63.10.00.602	
4 Perform Sleeve Concentricity check by rotating Tail Rotor Shaft with a Measure Dial on the Sleeve iaw MET 63.10.00.602, para. 5. <i>0,07mm</i>		MET 63.10.00.602	
5 Spray an even film of Molicote G Rapid+ on Sleeves. Install O-Ring, P/N MS 9388-133 on Sleeve, if removed.		MET 71.00.00.401 MET 63.10.00.602	
6 Clean and perform visual inspection of Bendix Shaft Flange with Splines iaw MET 63.10.00.602, para. 4.1. Spray an even film of Molycode G Rapid+ on Splined Flange.		MET 71.00.00.401 MET 63.10.00.602	
7 Check for correct position of Exhaust Nozzle, Oil Filler Cap, Exhaust Nozzle Drain and Blank Plate. INFO: Bendix Shaft removal-installation MET 63.10.00.401. Liaison Tube removal-installation MEM 72.51.401. NOTE: It is required to use long exhaust pipe when heatshield is removed from sliding cowling.		MET 71.00.00.401	
8 Perform visual inspection of Liaison Tube with NTL Harness and Heat Shield for condition and clamping.		MET 71.00.00.401 MEM 72.51.401	

A/C Type: AS332	A/C Reg:	Interval: Dependent		
Main Task: ENGINE REMOVAL - INSTALLATION.				Maintask number: 72
Zone: 100	Shop: 133	Mtoss: A40	ATA: 7100	Page-number: 1 of 2

	Subtask No.	Doc. ref. info.	Sign
INSTALLATION OF ENGINE.	480-03		
1 Install inflatable Seal on Engine Inlet and Seal on Bleed Valve, if not installed.		MET 71.00.00.401	
2 Install Sling and hoist Engine into place on Auxiliary Supports. Take care not damaging Firewall and Bendix Shaft.		MET 71.00.00.401	
3 Install Support Links with Bolts and Washers and torque iaw MET 71.00.00.401. Install Locking Pins.		MET 71.00.00.401	
4 Lubricate Tie Rod Bolts with O.156 Oil. Line up angular marks (if same engine and shaft and MGB is installed) and Couple Engine to MGB and torque Bolts iaw MET 71.00.00.401. Wire lock Bolts. Remove Sling. NOTE: If the temperature is below +10C, heat the Bendix Shaft Splined Flange and the O-Ring on Sleeve to approximately +30C with a Heat Gun before assembly.		MET 71.00.00.401	*
5 A. Pre-mod 332A07.22.576 (not adjustable supports): Check clearance between Support Plates and Auxiliary Supports. Front 11 +/- 2 mm. Rear 5 +/- 2 mm. B. Post-mod 332A07.22.576 (adjustable supports): Check clearance between Support Plates and Auxiliary Supports. Front 11 +/- 2 mm. Rear 1 + 1 - 0 mm.		MET 71.00.00.401	
6 Install 2 ea. Bonding Braids.		MET 71.00.00.401	
7 Clean 3 ea Electrical Connectors (male and female) with CO Cleaner. Install 3 ea Electrical Connectors.			
8 Install Starter Cables.		IPC 80.10.10 MEM IPC 80.10.01	

A/C Type: AS332	A/C Reg:	Interval: Dependent		HELIKOPTER SERVICE
Main Task: ENGINE REMOVAL - INSTALLATION.				Maintask number: 72
Zone: 100	Shop: 133	Mtoss: A40	ATA: 7100	Page-number: 2 of 2

	Subtask No.	Doc. ref. info.	Sign
INSTALLATION OF ENGINE.	480-03		
9 Connect P2 Line with Seal and install Clamp. Lock Screws. Check Line for shafing with other components.		MEM IPC 72.10.01	
10 Install and wire lock Fuel Supply Hose.			*
11 Install and wire lock 2 ea Bolts for Throttle Control. Lubricate Rod End with Lubriplate and install Rod End to Fuel Control and wire lock.			*
12 Install Hose for Engine Washing.			
13 Install Hose to Air Intake Inflatable Seal.		IPC 30.20.15	
14 Perform check and set of FCU iaw MEM 73.20.503. <i>Kam.</i>		MEM 73.20.503	
15 Check Fuel Flow Control setting iaw MET 76.10.00.501.		MET 76.10.00.501	*
16 Check Throttle for free travel and friction load on middle of Lever iaw MET 76.00.00.601.		MET 76.00.00.601	*
17 Bleed Fuel Control iaw MEM 73.00.201.		MEM 73.00.201	
18 Check and adjust Bleed Valve Seal to Engine Cowling.			
19 Check Air Intake concentricity iaw MET 53.50.00.501, para. 2.2.		MET 53.50.00.501	
20 Check Oil Level. Refill as necessary.			
21 Remove all Tools. Inspect Air Intake / Exhaust Nozzle for cleanliness and foreign objects. Close Cowlings.			

A/C Type: AS332	A/C Reg:	Interval: Dependant		HELIKOPTER SERVICE
Main Task: ENGINE REMOVAL - INSTALLATION.				Maintask number: 72
Zone: 100	Shop: 133	Mtoss: A70	ATA: 7100	Page-number: 1 of 1

	Subtask No.	Doc. ref. info.	Sign
CHECK AFTER INSTALLATION.	481-03		
1 Perform Engine Recovery Wash iaw MEM 71.00.701, if preserved.		MEM 71.00.701	
2 Perform Ground Run for 5 min with Throttle in Flight position. With Throttle in Flight position turn Booster Pumps off and check that engine does not flame out. Perform Rundown Time Check iaw MEM 71.00.03, para. 5 and record value: <u>2</u> Min <u>25</u> Sec		MEM 71.00.03	
3 Perform measurement of vibration level at 23000 RPM Input Shaft iaw MET 63.20.00.501 and record value: <u>0.08</u> IPS		MET 63.20.00.501	
4 Perform inspection of all (5 ea) Magnetic Plugs after Ground Run.		MEM 79.20.405	
5 Check MET 05.21.00.201, HS revision 340 for Flight Test Requirements and HS revision 311 for Maintenance Requirements after installation of Engine.		MET 05.21.00.201	

14.12 - «FREE TURBINE OVERSPEED» SAFETY SYSTEM CONTROLS AND DISPLAYS

14.12.1. «FREE TURBINE» OVERSPEED SAFETY PRINCIPLE

1 Need for «Overspeed» Safety

Should the engine-to-MGB drive shaft break, the free turbine rotating with no load races, and under the effect of very high centrifugal forces is likely to burst. Since the pilot does not have time to react or even realize what is happening, a safety system automatically and immediately shuts down the engine when the free turbine speed reaches 120 % of its nominal speed, i.e. 27 400 rpm (nominal speed : 22 850 rpm).

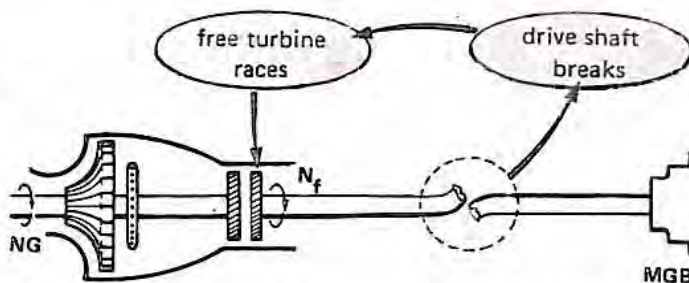

ENGINE AUTOMATICALLY SHUT DOWN FOR N_f 120 % OF NOMINAL N_f

2 «Overspeed» Safety System Operating Principle

When the N_f reaches 120 %, the detection logic (2) closes the engine solenoid valve (6) circuit, the solenoid valve opens, causing the bleed and overspeed valve (8) to close : fuel is cut off (injection wheel (7), is no longer supplied) THE ENGINE STOPS.

Moreover, logic (2) closes the indicator light (4) circuit via an oscillator (5) (the indicator light flashes) and inhibits the shutting down of the second engine and restarting of the engine shut down.

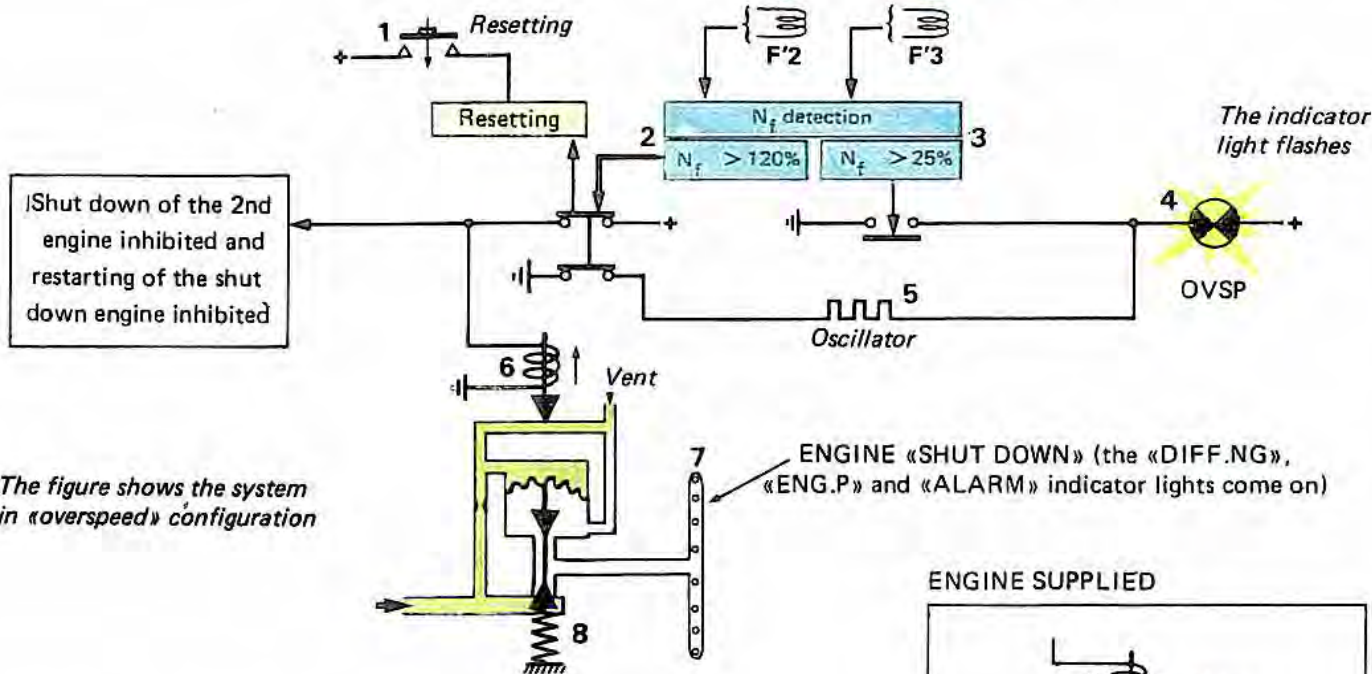
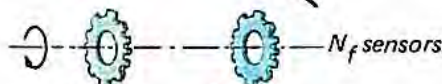
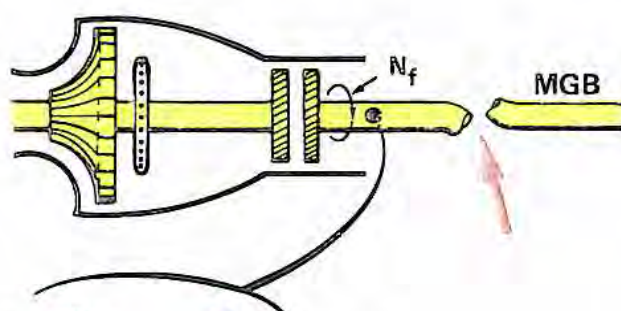

The figure shows the system in «overspeed» configuration

Resetting. When the system has operated, logic (2) remains locked. Once the failure has been corrected, the system must be reset : actuate resetting push-button (1)

Automatic Testing of the N_f Detection Circuits. As soon as the power system is energized, indicator light (4) should come on (and not flash). It should go out during the starting phase, when the N_f reaches 25 % (Action of logic 3).

System Control Test (Refer to next page).

ENGINE SUPPLIED

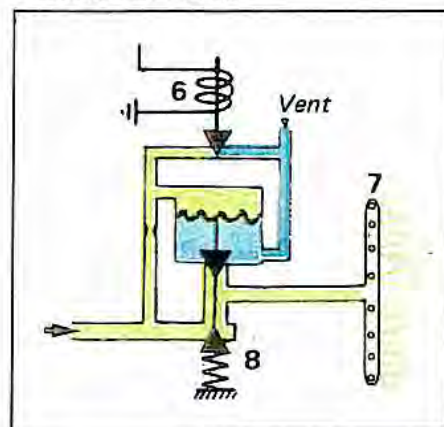

14.12.2. «FREE TURBINE» OVERSPEED SAFETY SYSTEM (Figure on page opposite)

- 1 - Resetting pushbutton
 - 2 - Oscillator
 - 3 - Overspeed solenoid valve
 - 4 - Injection wheel
 - 5 - Bleed and overspeed valve
 - 6 - Test pushbutton
 - 7 - Test logic circuit
- 36K1-36K2 - Engine electronic units
 49K1 - Engine 1 «starting» control relay
 L1-L2 - «Nf > 25 %» detection logic circuits
 L3-L4 - «Nf > 120 %» detection logic circuits
 S1-S2 - Overspeed solenoid valve control bistable relays
 T - Indicator light control transistor for Nf < 25 %
 V1-V2- Control relays Nf > 120 %
- There are also 4 indicator lights :
- OVSP.1 and OVSP.2 - These lights are lit continuously for Nf < 25 % and they flash if the overspeed system has operated
 - NORM. - «System correct» test indicator light
 - FAIL. - «System failed» test indicator light

- inhibits the excitation of engine 1 starting relay (49K1 (it cannot be re-started after overspeed)
- closes the OVSP.1 indicator light circuit via an oscillator (2) : THE INDICATOR LIGHT FLASHES.
- places the base of transistor T out of circuit. T is jammed.

NOTE :

① Operation on OVSP.1 indicator light automatic testing : as soon as the aircraft power system is energized transistor T is polarized (S1 in «rest» position) it conducts the indicator light comes on (logic circuits L1 and L2 are closed) and remains lit until Nf > 25 % when logic circuits L1 and L2 open. Illumination of the indicator light and extinction for Nf > 25 % indicate that the Nf detection circuits are operating correctly.

② Relay S1 is bistable. When energized it remains locked in «working» position. The system must be reset by pressing pushbutton (1) which energizes the relay in the opposite direction, returning it to «rest» position.

③ System Testing. The test logic (7) supplies 2 oscillators the frequency of which is greater than that of the «120% Nf» threshold and starts the following sequence resetting overspeed test, mutual monitoring test of 2 circuits (shut down of an engine inhibited when the other engine is already shut down).

SYSTEM OPERATION

The operation is simple and has already been explained. Take, for example, overspeed on engine 1 :

- Logic circuits L3 and L4 close relay V1 circuit (Relay circuit V1 passes via the rest contacts of engine 2 relays S2 and V2).
- V1 in «working» position energizes relay S1, which trips to «working» position, and :
- supplies solenoid valve (3) : fuel cut off - Engine shut down
- inhibits the excitation of relay V2 (engine 2 cannot be shut down in the event of overspeed on this engine)

When pushbutton (6) is pressed :

- The system operates correctly if :
 - the NORM indicator light comes on
 - both OVSP indicator lights flash twice then remain lit continuously.
- The system has failed if :
 - the FAIL indicator comes on. In this case, one of the OVSP lights flashes indicating the failed system.

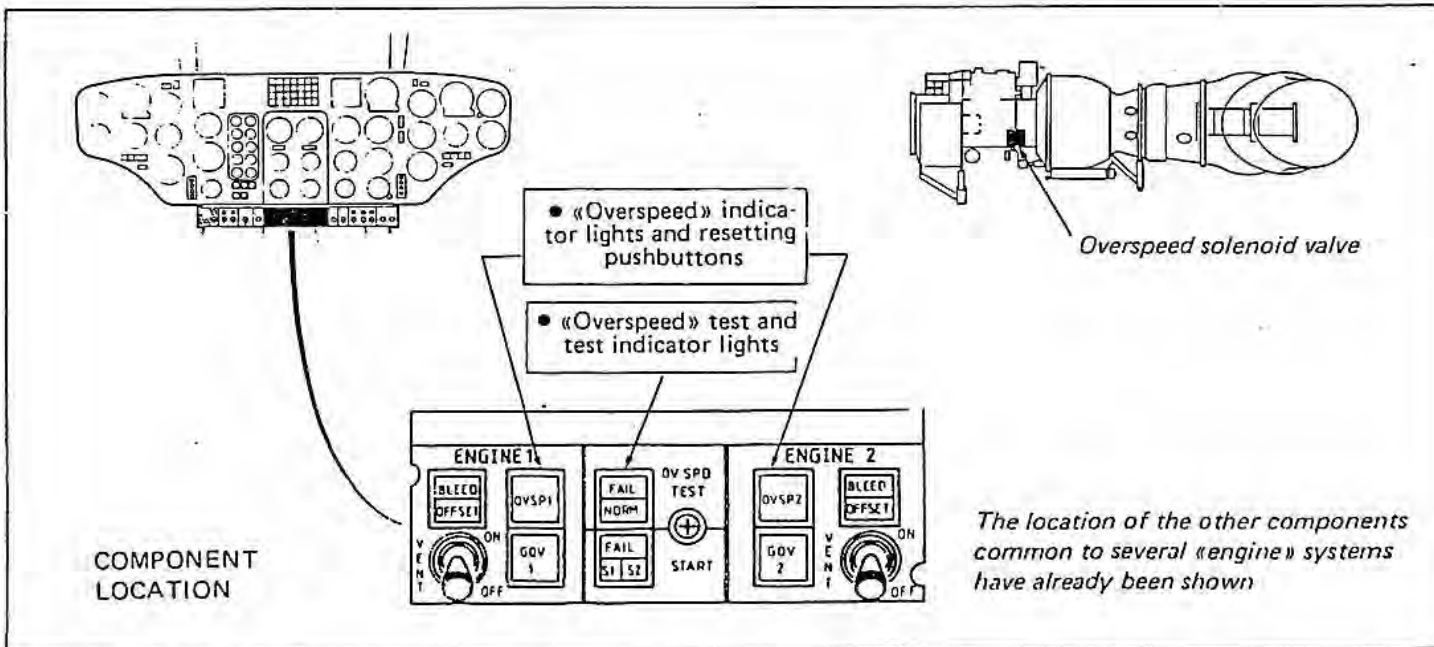

The location of the other components common to several «engine» systems have already been shown

14.12.2. «FREE TURBINE OVERSPEED» SAFETY SYSTEM (Cont'd)

ENG. 1

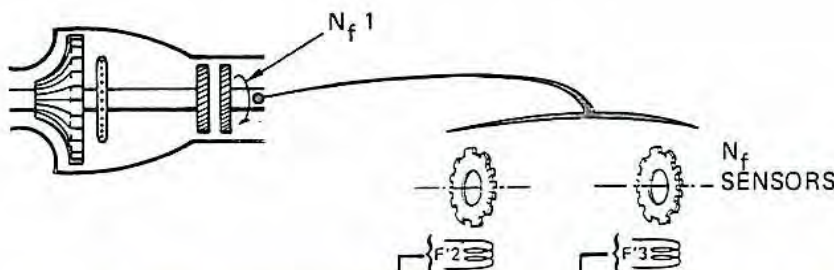

ENGINE 1 SYSTEM shown in rest position

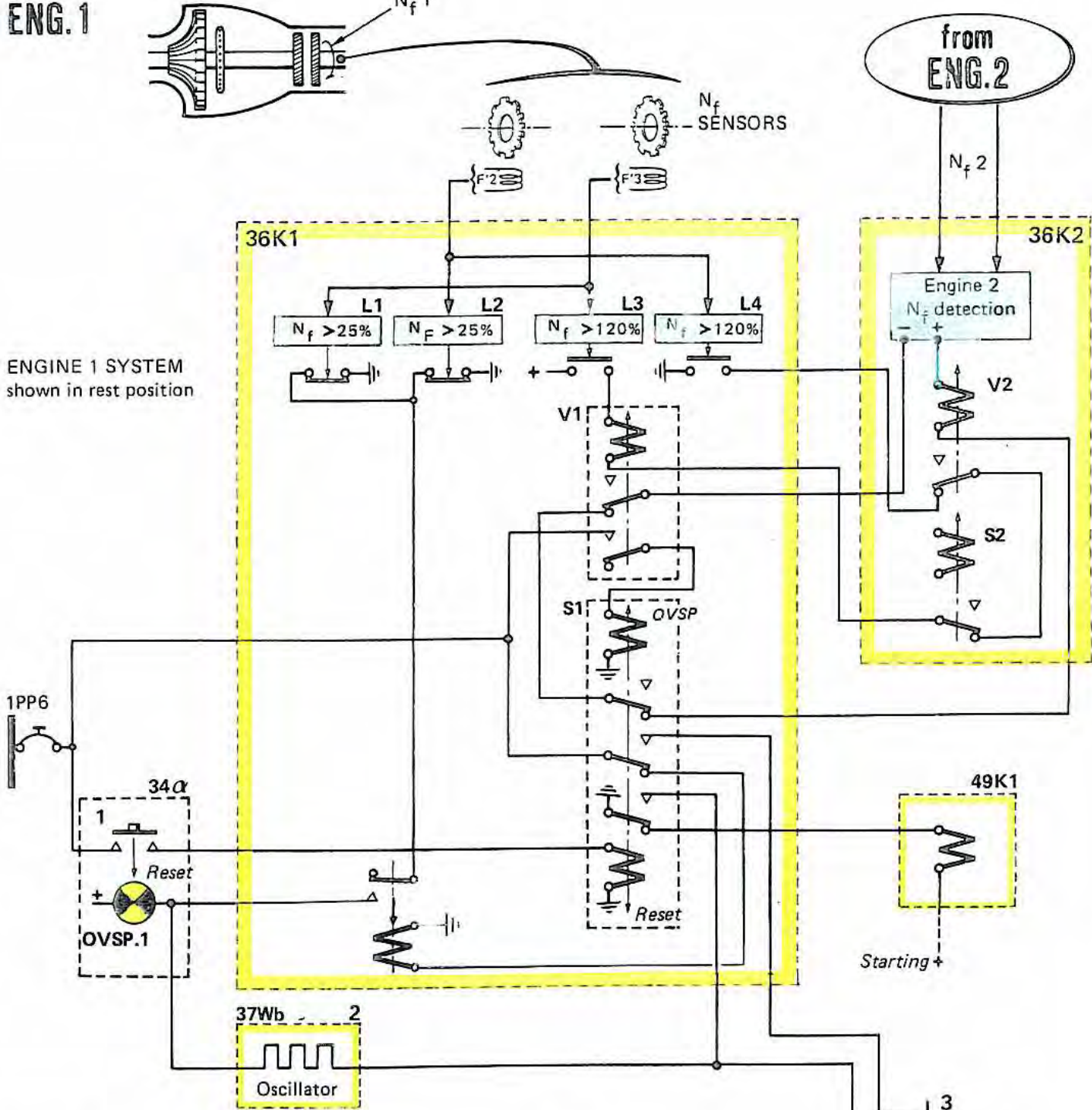

CIRCUITS TEST

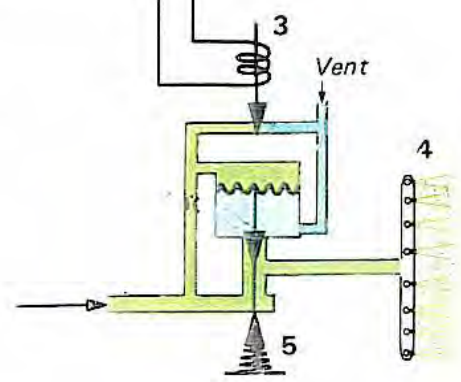
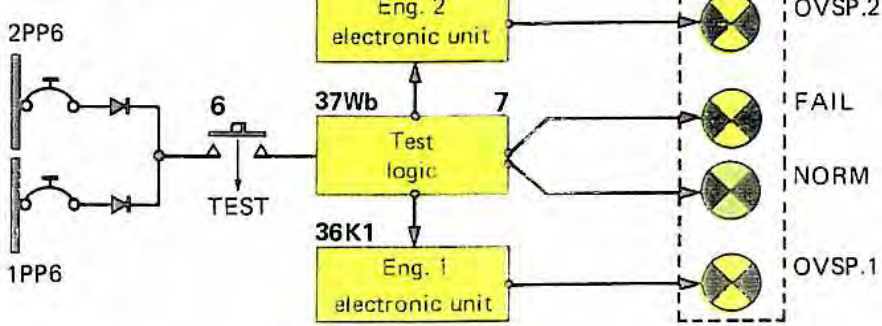

ACCIDENT LN-OPG - AS 332 L1 S/N 2344

COMMENTS ON THE CONCLUSION & RECOMMENDATIONS ON THE DRAFT OF THE FINAL REPORT

Comments outline

Introduction

Comments:

The sections in the Conclusion and Recommendations have been grouped together to present Eurocopter comments according to the following themes:

- The Aircraft
- Maintenance (Publication & NDT process)
- 8000 rpm Wheel wear & Vibration
- Failure process & crack propagation
- Hard metal coating (Technology & Process quality)

COMMENTS ON THE CONCLUSION & RECOMMENDATIONS ON THE DRAFT OF THE FINAL
 REPORT

INTRODUCTION

The Conclusions and Recommendations contained in the AAIB/N preliminary report were derived from the analysis discussed in this report, consequently Eurocopter will restrict itself to making comments about the points in the Conclusion and Recommendations.

Eurocopter will only make comments on points of disagreement or points for which an additional degree of clarification is necessary.

COMMENTS

The Aircraft

§ 3.1.2 l) "The OVSP light was located in such a position that it could be difficult to detect and to differentiate it from other information lights in the cockpit".

Eurocopter position (EC):

- The overspeed Amber light is a light which allows the crew to detect, after the event, the origin of a malfunction. There is no immediate corrective action to take. As the information given has no priority the light has been located together with the other engine auxiliary information. The light remains on, blinking, until the end of the flight.

Maintenance

§ 3.1.3 e) "The maintenance instructions, MET 63.10.00.602, do not make it mandatory to inspect for wear or other damage on the splines,"

EC:

- The WC 63.10.00.602 called by the MSR (PRE) in the chapter "Airworthiness limitations", was introduced by the mandatory SB 63.21, itself covered by an Airworthiness Directive. By the way, the requested inspection becomes mandatory.
- In the § 3.3 of the WC, it is requested to check if there is "Fretting Corrosion marks, wear or scratches which are not removable by sanding". This check concerns the entire sleeve and leads to the change of it when presence of Fretting Corrosion, wear or scratches:
In the § 4.1, It is requested to "check the condition of the splined flange".
- **Conclusion**
Eurocopter is of the opinion that inspect for "Fretting Corrosion, wear or scratches" and "check the condition of splined flange" covers the "inspection for wear or other damage" on splines either on sleeve or flange.

COMMENTS ON THE CONCLUSION & RECOMMENDATIONS ON THE DRAFT OF THE FINAL
 REPORT

§ 3.1.3 h) "Eurocopter France has not been consistent in describing or assigning names to parts of the helicopter. Because of this, the same part may have several different names depending on where it is mentioned."

EC:

- The reference for name is the drawing. This name is recaptured by the IPC (Illustrated Parts Catalogue), MET or MMA and (Maintenance Manual) and MRV (Overhaul Manual). This is an Eurocopter rule in force in the publication. However, in case of synonyms used through the translation process, each word is used in a restrictive context and cannot be a source of errors.

§ 3.1.3 l) "The inspection requirements with regard to wear on the 8000 rpm wheel, as stated in the MRV, are insufficient to weed out examples that subsequently prove to be the cause of undesired vibrations in the MGB"

§ 4) "In collaboration with the civil aviation authorities in France, the NCAA should direct Eurocopter to revise the overhaul criteria for the input pinion and the 8000 rpm wheel on the AS332L1"

EC:

- The inspection requirements regarding the wear of the 8000 rpm wheel teeth is of the same standard than any of the other Eurocopter product gears or competitors gears. The general inspection rule during an overhaul consists to perform a visual check and, if a discrepancy is found, a dimensional check.
- The type of wear observed, time to time, on the 8000 rpm wheel teeth is unusual because it is a shiny pattern instead of a pitting or spalling pattern generally observed on gear teeth and more easily detectable. This wear is generated by the dispersion of roughness of the 23000 rpm pinion.
It has been demonstrated by test that the vibration generated by this wear has no influence on the 23000 rpm splined sleeve behaviour
 In order to improve the reliability, to get the benefit of the new MK II technology and to avoid the inspection difficulty, as an overhaul centre is not equipped with the measuring machine to check the tooth profile, Eurocopter has decided to ask overhaul centres to retrofit the MGB MK I with the nitrided wheel (more resistant to wear) in service on the MKII. It has been also requested to send back to EC a certain race of 23000 rpm pinion in order to check the teeth roughness.

COMMENTS ON THE CONCLUSION & RECOMMENDATIONS ON THE DRAFT OF THE FINAL
 REPORT

§ 4) "In collaboration with the civil aviation authorities in France, the NCAA should direct Eurocopter to revise the maintenance requirements for the splined sleeve and the splined flange on the AS332L1"

EC:

□ Eurocopter has already taken several steps of maintenance presentation improvements starting in 1998. These include reorganisation of the WC 62.10.00.602 and the update of the mandatory SB which brings more details. A modification has been issued to render the sleeve and flange serialised in order to facilitate the monitoring on a log card.

§ 4) "In collaboration with the civil aviation authorities in France, the NCAA should assess whether to direct Eurocopter to draw up a plan for increasing the user-friendliness and clarity of the maintenance programme and the information provided by the factory.

EC:

□ EC has already modified the relevant publication in order to improve the clarity of the maintenance program and introduced the issue of new documentation update by Letter-Service to increase its user-friendliness:

□ N° 1385-63-99 which purpose is to inform the operators about the update of the maintenance. It gives a detailed sum-up of the 23000 rpm MGB inputs and Bendix shaft maintenance.

□ N° 1455-63-00 which purpose is to inform the operators about the modifications introducing the serialised splined sleeve and flange in order to facilitate the monitoring of these parts.

§ 3.1.3 f) « The AAIB/N believes that the described NDT-method has weaknesses and limitations in its capability to detect small cracks in the surface coating »

EC:

- The recommended inspection method by fluorescent dye penetration complies with aeronautical maintenance practice. It does not have any weakness related to detection of small cracks including on a "Flame plating" coated surface.
- Among the different "NDT" method, the fluorescent dye penetrant is the best adapted method to the part morphology and to the in line maintenance type.
- It requires thorough cleaning of the part before it can be done. Cleaning implies a visual examination which, for the splined sleeve, enables detection of wear on the splines; wear being a preliminary step before crack initiation.

COMMENTS ON THE CONCLUSION & RECOMMENDATIONS ON THE DRAFT OF THE FINAL
 REPORT

8000 rpm wheel

§3.1.2 i) p156 " IHUMS information from several of the company's helicopters was analysed after the accident. This showed that LN-OPG had a gearbox with a vibration pattern which was different, in significant respects, from what might have been expected on the basis of past experience."

§ 3.2. b) p160 "The main gearbox M170 had a nonconformity in the vibration pattern recorded by HUMS in relation to other equivalent MGBs in the company's fleet. A similar vibration pattern was recorded from MGB nos. M136 and M665 (with parts from LN-OPG and MGB no. M136). The AAIB/N has not done any further examination of the effects of these vibrations, and cannot draw any final conclusion from this. Consequently these non conforming vibration patterns cannot be linked directly to the accident as a causal factor"

§ 4. P164 "In collaboration with the civil aviation authorities in France, the Norwegian Civil Aviation Authority should direct Eurocopter to implement a project to map out any connections which might exist between vibrations occurring in the main gearbox and loadings occurring in the drive train between the engine and the main gearbox"

EC:

- The specific feature of the vibrational signature of main gearbox M170 (38 omega phenomenon) is caused solely by wear of the 8000 wheel teeth. This phenomenon has been observed on aircraft in the Super Puma fleet for many years. It occurs at a frequency of 5000 Hz, and therefore cannot be detected using conventional maintenance means (Chadwick, etc.), but it can be displayed very well with current HUMS systems
- No link between the vibration signature in 38 omega and an overload on the sleeve flange coupling has been evidenced through all the investigations carried out (modelling and measurements).
- Furthermore, several worn wheels have been identified with sleeves in good condition. A recent example is main gearbox M197 (installed at NHS) that continued for more than 2000 hours with a worn wheel and on which several sleeves installed one after the other showed no signs of abnormal wear (disassembly for inspection of the sleeve performed every 500 hours by NHS).

Conclusion:

This "non conformity" in the vibration pattern, recorded by HUMS on the MGB M170 is not a contributory factor to the splined coupling failure.

COMMENTS ON THE CONCLUSION & RECOMMENDATIONS ON THE DRAFT OF THE FINAL
 REPORT

Failure process

§ 3.1.4 a) "It has not been possible to determine with certainty why the R/H splined sleeve on LN-OPG began to crack."

§ 3.2. c) "The R/H splined sleeve did not have the prescribed O-ring and this contributed to an increase in the freedom of movement between the splined flange. However, it seems evident that the fatigue cracks in the splined sleeve did not initiate as a result of a missing O-ring, but that the subsequent crack propagation in the splined sleeve may have been hastened by this deficiency."

EC:

- A number of investigations were carried out based on the results of examinations performed on parts on which accidents had occurred, analyses of incidents in 1984-1987 and the analysis of similar incidents in Sweden and Japan:
 - calculation of the fatigue strength to determine necessary and sufficient conditions for splines failure
 - bench tests of the main gearbox: confirmation of the kinetic behavior of the splined coupling and the wear phenomenon
 - tests on aircraft, to perform vibrational measurements on the complete dynamic system consisting of the main gearbox - shaft - engines

- These investigations have permitted to set up the failure process, the influence of the various factors on the splined coupling and the failure history. The fact that there is no O-ring enables an angular movement in the splined link 50% greater than the movement in a splined assembly at the maximum wear removal criterion. The lack of the O-ring generates dynamic stresses in the splines and an abnormal wear rate that affects the strength of the part. The combination of these two phenomena, loss of strength and dynamic stresses, is a deciding factor in the splines crack initiation and propagation.

Conclusion:

The lack of the O-ring is an essential factor in the failure process.

The conclusion of this analysis is consistent with past experience. The removal of the O-ring in the assembly following the modification in 1985 quickly led to in-service cracks in the sleeve similar to the LN-OPG case (the Sealand AS332 L2016 & the Helikopter Service AS332 L2073 aircraft). Modification AMS 52.297 (01.86) was immediately implemented to reintroduce the O-ring in the assembly (Mandatory SB 63.21 dated 86.04 - Airworthiness Directive No. 23).

COMMENTS ON THE CONCLUSION & RECOMMENDATIONS ON THE DRAFT OF THE FINAL
 REPORT

§ 3.1.4 e) p 158 "The splined flange began to crack on 31 August 1997, approx. 62 flying hours before the accident"

§ 3.2 e) p 161 "Based on the material available, the AAIB/N believes that a series of fatigue cracks arose in the splined sleeve in question, during the period 121 to 62 flying hours prior to the accident. This corresponds to the period 22 to 31 August 1997. However, it is probable that the cracks began to form several dozen before 31 August".

EC:

- The DNV has evidenced, on the failure, three types of fatigue marks: Strongly marked stop lines, finer and numerous stop lines and fine striations.
- The DNV has retained the strongly marked stop lines to assess the crack propagation time. The EC and DNV results related to the mark counting on flange and sleeve are consistent.
- The EC experience in this field shows that, generally speaking, the fatigue ruptures showing these three kinds of fatigue marks are interpreted as follow:
 - the strongly marked lines are representative of the rotor stoppage cycles
 - the finer and numerous stop lines are representatives of the torque variation cycles
 - the fine striation are representative of vibratory fatigue cycles.
 This interpretation is confirmed by the Eurocopter laboratory investigations on Japan and Sweden similar incidents. In both cases the number of strongly marked stop lines are very well correlated with the rotor stoppage cycles.

Conclusion:

Eurocopter considers that the strongly marked stop lines , in the LN-OPG case are representative of the rotor stoppage cycles.

- **Based on the marks count, it is deduced that:**
 - the flange began to crack at 234 h. before the accident, namely at about 8/08/97 (a/c time: 7561 h.).
 - the sleeve began to crack not later than 201 h. before the accident, namely at about 12/08/97, at the latest (a/c time: 7594 h.).

Consequently the sleeve was partially broken on the date of the NDT inspection (23/08/97). Please refer to the graph page 10/12.

This chronology is consistent with the vibration history of the recorded signal on the engine side (1 Omega unbalance). The change in slope of the vibration signal that occurred shortly after this period from August 8-12 could correspond to the unbalance generated by the gradual loss of stiffness of the assembly (cracks propagation in the splined sleeve and flange)

Considering the demonstration elements above and experience acquired through HUMS systems, the absence of "step change" in the vibration level is not consistent with a disassembly and re-assembly operation needed to perform the "NDT inspection" of the 23 000 rpm coupling.

COMMENTS ON THE CONCLUSION & RECOMMENDATIONS ON THE DRAFT OF THE FINAL
 REPORT

§ 3.1.4 f) "The splined sleeve began to crack before the splined flange".

EC:

- The most probable assumption is that the brutal vibration increase on the 3 of September is due to the unbalance generated by the crack "opening" of the splined flange which allows, consequently and simultaneously, the crack "opening" on the sleeve because the flange forms a retaining cage around the sleeve. This implies that the crack "opening" on the sleeve occurred, at the latest, at the same time than the one on the flange.
According to Eurocopter hypothesis about the crack propagation beach marks counting (120 on flange and 83 on sleeve) and the above considerations, Eurocopter cannot be sure which one occurs the first. (Please refer to the graph page 9/12)

§ 3.1.4 h) "There are no findings to indicate that the crack in the splined sleeve arose as a result of deficient lubrication"

EC:

- It has to be also stated that there is no findings to eliminate the lubrication as a contributing factor in the wearing process as demonstrated in the Eurocopter test results summary already provided and discussed with AAIB/N.

§ 3.2 k) "The cracking of the splined sleeve gradually brought about the fracture of the Bendix shaft".

EC:

- The sequences of event are the following:
 - Wear has been initiated on the splined sleeve and flange by a powerful fretting process
 - Cracking process has been initiated due to the wear (stress concentration and lower fatigue resistance) under dynamic loads.
 - The cracking ended in opening the flange and sleeve which frees the nut lock washer. Then the nut lock washer fell, later on, inside the Bendix shaft
 - The unbalance thus created brought about the fracture of the Bendix shaft.

COMMENTS ON THE CONCLUSIONS & RECOMMENDATIONS ON THE DRAFT OF THE FINAL REPORT

Failure Process

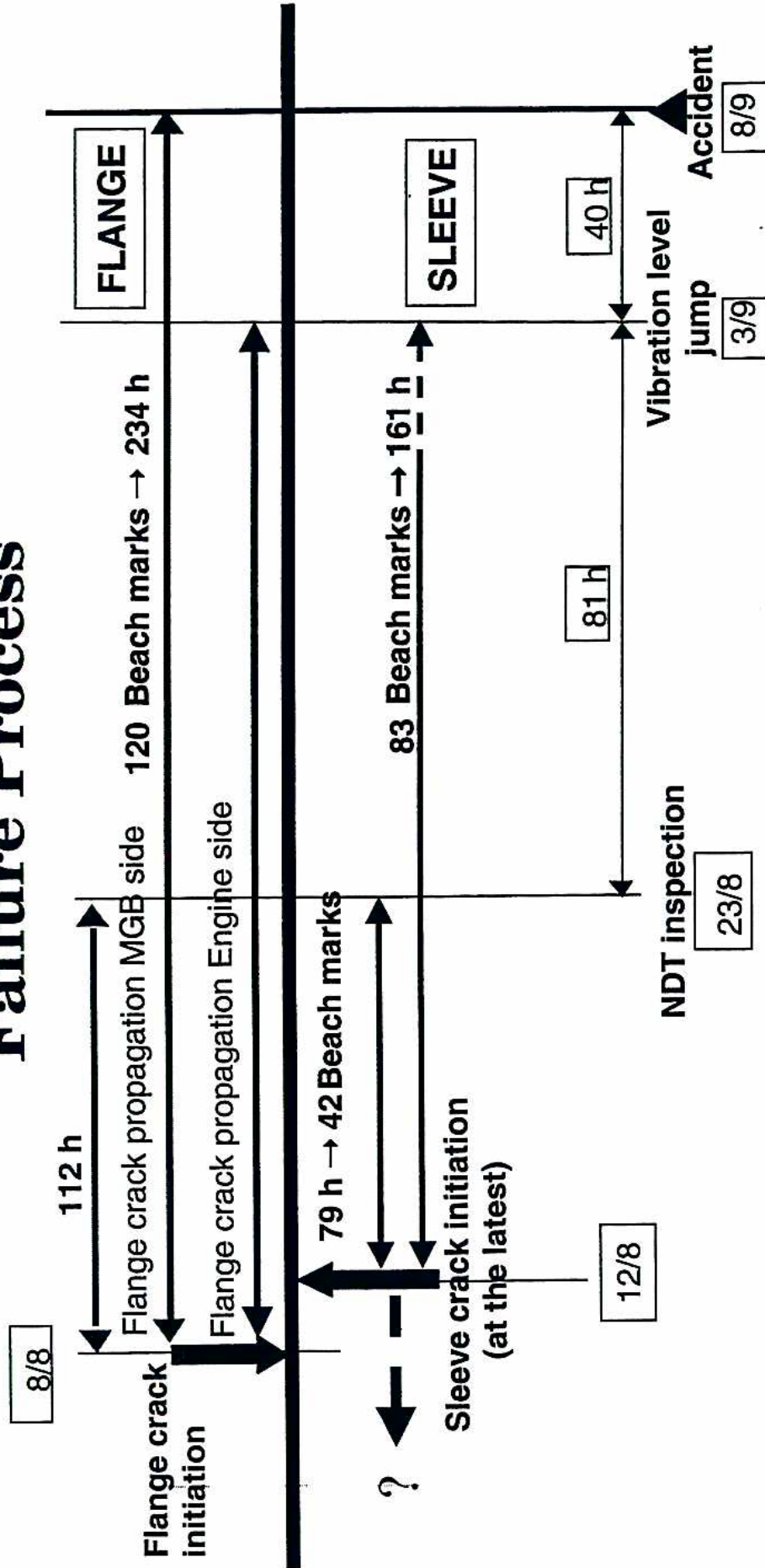

"Ce document est la propriété d'EUROCOPTER, il ne peut être communiqué à des tiers et/ou reproduit sans l'autorisation préalable écrite d'EUROCOPTER et son contenu ne peut être divulgué". © EUROCOPTER 04/2001

COMMENTS ON THE CONCLUSIONS & RECOMMENDATIONS ON THE DRAFT OF THE FINAL REPORT

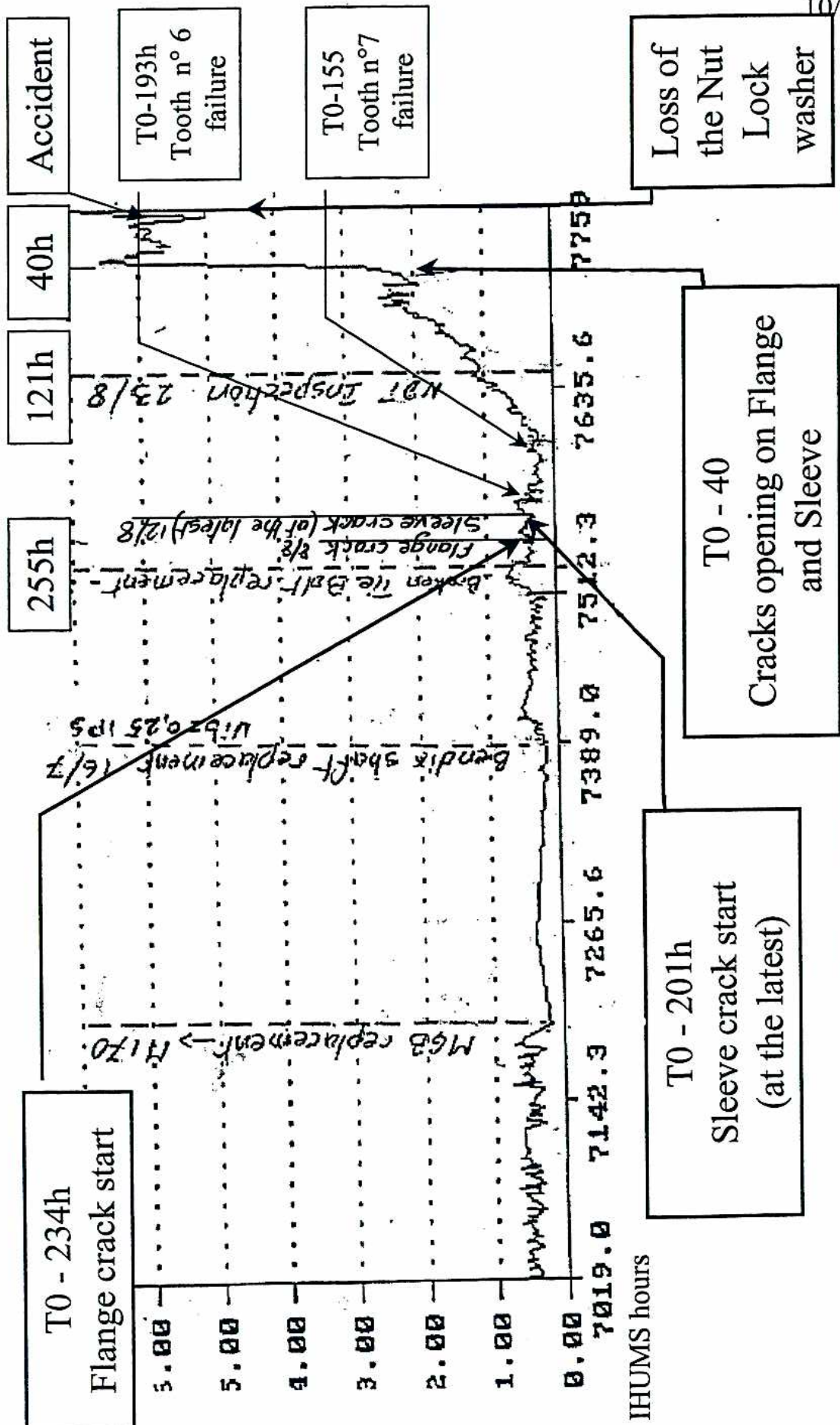

"Ce document est la propriété d'EUROCOPTER, il ne peut être communiqué à des tiers et/ou reproduit sans l'autorisation préalable écrite d'EUROCOPTER et son contenu ne peut être divulgué". © EUROCOPTER 04/2001

COMMENTS ON THE CONCLUSION & RECOMMENDATIONS ON THE DRAFT OF THE FINAL
 REPORT

Hard metal coating

§3.1.2 c) " ECF chose to surface coat the splined sleeve with a type of plasma spray based on experiences gathered from completely different components used on other helicopter. It is the opinion of the AAIB/N that there is no comparison between these components and that the choice of coating is therefore not necessarily ideal"

EC:

- The choice of the CWCO carbide plating was made based on experience with specific parts and tests to evaluate the behavior of mechanical helicopter parts under all usage cases:
 - tests on fretting fatigue test samples: the behavior demonstrated by these tests is excellent:
 - the behavior of the basic material without fretting is restored
 - the flame plating process is one of the best surface treatments currently known against Fretting Corrosion.
 - wear tests on disks rotating at high speed: CWCO is one of the best wear treatments at pressures of up to 1200 MPa (pressure significantly higher than the pressure on the splined sleeve): no significant wear observed.
 - wear tests of the cylinder / plan contact: It was demonstrated that wear, when it occurs, is gradual.

CONCLUSION: CWCO plating is a surface treatment adapted to sleeve operating conditions; namely limitation or elimination of wear. The PRAXAIR company's carbide "flame plating" process is one of the most efficient.

EUROCOPTER uses the CWCO plating for areas subject to intense fretting and/or severe wear.

Experience on several types of parts has always demonstrated satisfactory behavior.

Consequently the EC choice is justified and is the best solution.

§ 3.1.4 k) "The hard metal coating on the splined sleeve contained grains of Tungsten carbide of a size equivalent to or greater than the thickness of the coating"

§ 3.2 a) "The investigation has proven that the hard metal coating on the R/H splined sleeve did not comply with the specifications in several areas. In combination with several scratches in the coating, this reduced the wear resistance of the coating to a significant extent".

EC:

- It is correct that a detailed metallographic examination with a large magnification of the carbide coating on sleeves can locally demonstrate some differences concerning the porosity level, or small separations, or a thickness variation. On the other hand, the change in the size of carbides is normal, considering the size grading of the powder used.

COMMENTS ON THE CONCLUSION & RECOMMENDATIONS ON THE DRAFT OF THE FINAL
 REPORT

- These differences can be observed particularly at the bottom and top of the splines, and are inherent to the coating process.
Dispersion of a series production is very low, considering the frozen manufacturing and inspection processes. Differences identified by the DNV (as mentioned above and scratches on the coating surface) have also been observed on sleeves after operation for several thousand hours without any particular damage to the coating. These differences are within the normal dispersion of series production.
Therefore, variations observed on the LN-OPG sleeve are therefore representative of the variations of the whole other sleeve population in use.
- In every splined coupling there is an intrinsic play which allows micro movements. If AAIB/N hypothesis is true, we should have wear on all the splined sleeve inspected during checks or overhauls.
- However, the in service experience on the sleeve hard metal coating is excellent. No sign of fretting corrosion is present on the splined sleeve entering the overhaul process each 3000 hours. We have several instances in which failure of the Bendix shaft diaphragms do not induced any damage on the splined sleeve. Further more, the condition of the splined sleeve related to "undesired" vibration cases, is very good. Not a single case of fretting corrosion or hard coating flake off have been reported from the fleet.
The in service experience is based on a fleet flight time of more than 2 000 000 hours (4 000 000 hours on the splined sleeve)

Conclusion:

The Praxair "Flame plating" process is suitable for this application.

§4 "In collaboration with the civil aviation authorities en France, the Norwegian Civil Aviation Authority should direct Eurocopter to assess Whether the requirements for final production control of the splined sleeve on AS 332L1s are sufficient."

EC:

- The inspection procedure guarantees all the drawing characteristics and is sufficient to ensure conformity.
This inspection is representative of a Safety Class 1 procedure.

MRSno.	nummer på vedlikeholdsoppgave i henhold til MRS
MRV	Eurocopter Overhaul Manual – overhalingshåndbok fra ECF
NCAA	Civil Aviation Authority Norway – Luftfartsverket (Nå Luftfartstilsynet)
NDT	Non Destructive Testing
Nf	turtall på kraftturbinen – speed on turbine
Ng	turtall på gassgenerator – speed on gas generator
NIL	intet (om vær)
NM	Nautical Mile(s) – nautisk(e) mil
Nm	Newton meter
Nr	turtall på rotor – speed on rotor
OC	On Condition – vedlikeholdsprosess
OSC	On Scene Commander
OSM	Optical Stereo Microscope – optisk stereomikroskop
OVSP	overspeed – for høyt turtall/fart
P	Planning - planlegging
PFC	Pre Flight Check
PM	Procedures Manual – prosedyremanual
PM-L	Procedures Manual Logistic – prosedyremanual logistikk
PM-MR	Procedures Manual Maintenance Records
PM-TD	Procedures Manual Technical Data
PRE	fransk betegnelse for Master Servicing Recommendation - vedlikeholdsprogram
RA	Rain – regn
RADZ	Rain/Drizzle – regn/yr
RH	Right Hand – høyre
ROV	Remotely Operated Vehicle
RPM	Revolutions Per Minute – omdreininger per minutt
SB	Service Bulletin – meddelelse fra fabrikant
SCT	Scattered – spredt (om skyer)
SE	Sout East – sørøst
SEM	Scannin Electronic Microscope - elektronmikroskop
SHRA	Rainshowers – regnbyger
SIG_PP	Peak to Peak of signal average
SIG_SD	Standard Deviation of the signal average
SINTEF	Stiftelsen for Industriell og TEknisk Forskning
SL	Service Letter – meddelelse fra fabrikant
SW	South West – sørvest
T	Tidspunkt bestemt til kl. 06:56:30
TAF	Terminal Aerodrome Forecast – værvarsel for flyplass
TCU	Towering Cumulus – opptårnet cumulus
Tq	Torque – dreiemoment/tiltrekningsmoment
T4	Turbine Temperature
Q	forkortelse for QNH benyttet i METAR
QA	Quality Assurance - kvalitetssikring
QNH	høydemålerinnstilling relatert til trykket ved havets overflate
UTC	Universal Time Coordinated

VIS	Visibility
W	West – vest
W.C.	Work Card – arbeidskort
WX	vær
XNNE	ICAO kode for oljeproduksjonsskipet "Norne"
Ø	øst - east
µm	en tusendels mm

FLIGHT TIME - EVENT

MGB replaced 613 H

3/6

Number of flight hrs before the accident

550 H

500 H

18/6

450 H

25/6

400 H

16/6

Shaft replaced 383 H

350 H

EPI BRG FWD (ALB x 10) x

ENG 2 (ALB x 10) x

7
6
5
4
3
2
1

x
x
x
x
x
x

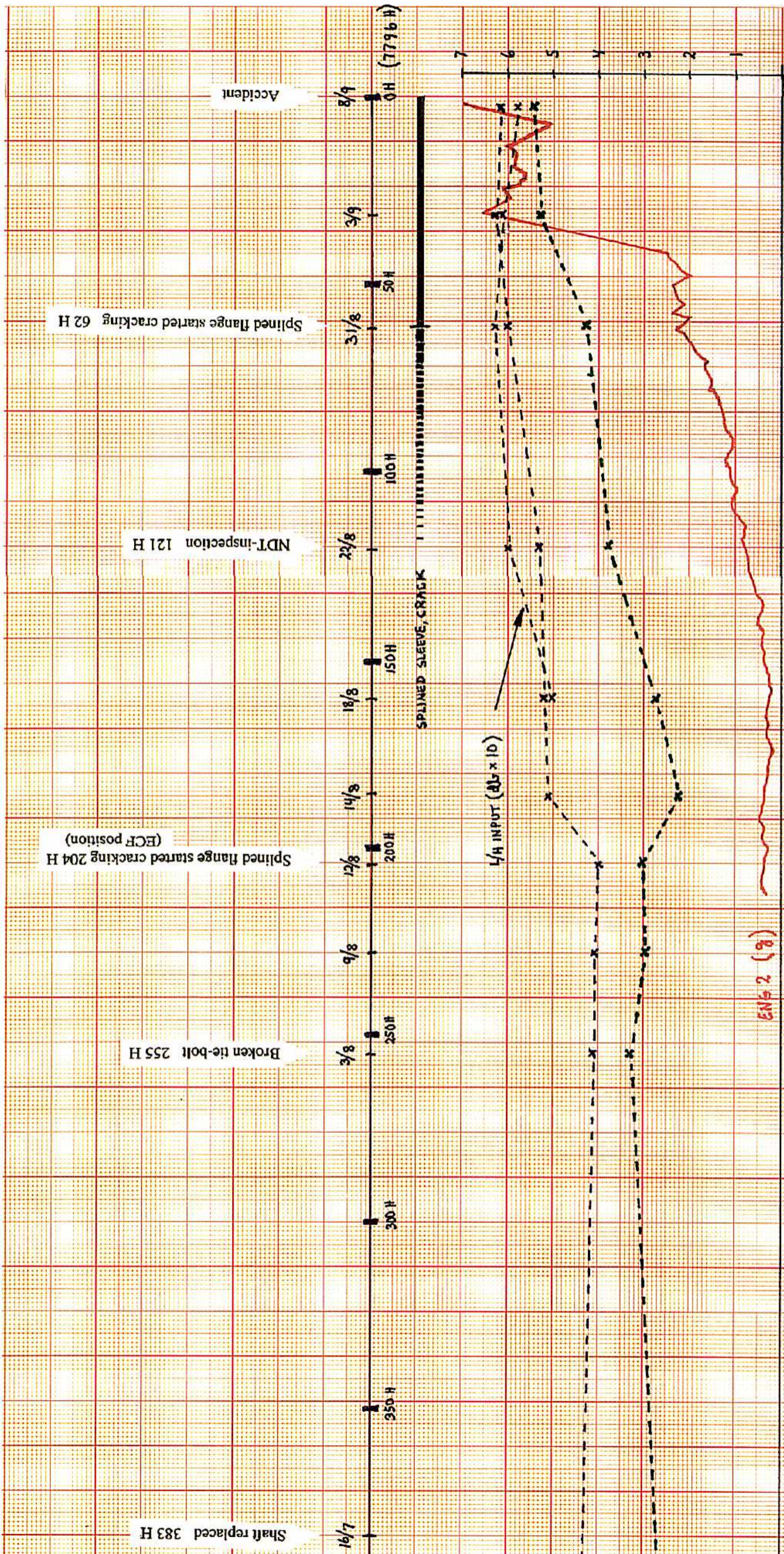

EN 2 (8)